

# On Jargon

## The Lost Art of Nomography

Ron Doerfler  
 Naperville, IL  
<http://www.myreckonings.com>  
[rondoerfler@myreckonings.com](mailto:rondoerfler@myreckonings.com)

### Introduction

Nomography, truly a forgotten art, is the graphical representation of mathematical relationships or laws (the Greek word for law is *nomos*). These graphs are variously called nomograms (the term used here), nomographs, alignment charts, and abacs. This area of practical and theoretical mathematics was invented in 1880 by Maurice d’Ocagne (1862–1938) and used extensively into the 1970s to provide engineers with fast graphical calculations of complicated formulas to a practical precision.

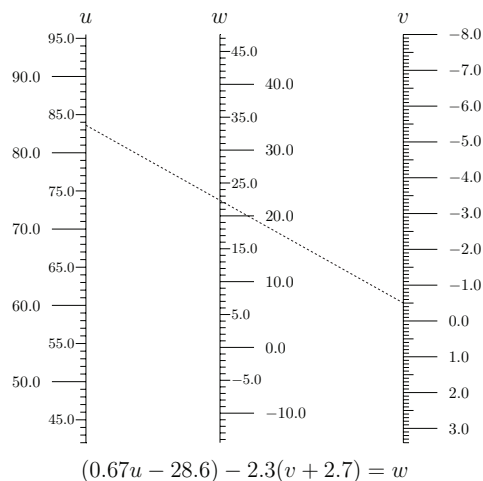

**Figure 1.** A nomogram for a simple linear equation.

The simplest nomogram consists of three or more straight or curved scales, each representing a function of a single variable appearing in an equation. **Figure 1** shows such a nomogram for a linear equation in three variables. A straightedge is placed across these scales at known values of the variables, and an unknown variable is found as the value crossed on

---

*The UMAP Journal* 30 (4) (2009) 457–493. ©Copyright 2009 by COMAP, Inc. All rights reserved. Permission to make digital or hard copies of part or all of this work for personal or classroom use is granted without fee provided that copies are not made or distributed for profit or commercial advantage and that copies bear this notice. Abstracting with credit is permitted, but copyrights for components of this work owned by others than COMAP must be honored. To copy otherwise, to republish, to post on servers, or to redistribute to lists requires prior permission from COMAP.

its scale. We will see that this style of nomogram can also be constructed for much more complicated equations. Nomograms are generally drawn for equations having three or more variables, where the equivalent graphs would consist of families of curves or 3D plots. The startling simplicity of nomograms is apparent by comparison to these multivariable graphs.

Along with the mathematics involved, a great deal of ingenuity went into the design of nomograms to increase their utility as well as their precision. Many books were written on nomography and then driven out of print with the spread of computers and calculators. Nomograms are sometimes observed in the wild today, but in a modern setting they seem odd and strangely old-fashioned. But an unusual one provokes interest because of the technical, even artistic, creativity apparent in its design. And there is much creativity: The theory of nomograms draws “on every aspect of analytic, descriptive, and projective geometries, the several fields of algebra, and other mathematical fields” [Douglass and Adams 1947]. In fact, two nomograms for the same equation can look vastly different, depending on the inspiration of the designers. Looking through publications of nomograms evokes the feel of browsing an artist’s portfolio.

Slide rules were manual calculators contemporary with nomograms, and they are familiar today from their appearance; but most engineers have never seen a nomogram and wouldn’t know what to do with one if they did. A slide rule is designed to provide basic arithmetic operations to solve a wide variety of equations with a sequence of steps, while the traditional nomogram is designed to solve a specific equation in one step. Although nomograms are not common today, it’s interesting to note that the quiet, less flashy nomogram has in fact outlived the more popular slide rule.

This article describes why nomograms work and how they are constructed from scratch. We first review designs based on geometric relationships, then radically advance the possible designs through the use of determinants, and end with transformations that can be applied to customize a nomogram for precise and compact use.

## Geometric Design

Nomograms composed of straight scales can be designed by analyzing their geometric properties, and a variety of interesting nomograms can be constructed from these derivations. Certainly, the designs in this section are the most prevalent types of nomograms. The examples here are presented as small figures, but in practice the nomograms would be printed on large sheets of paper with much finer tickmark spacing for greater precision.

### Parallel-Scale Nomograms

Figure 2 shows the basic parallel-scale nomogram for calculating a value  $f_3(w)$  as the sum of two functions  $f_1(u)$  and  $f_2(v)$ :

$$f_1(u) + f_2(v) = f_3(w).$$

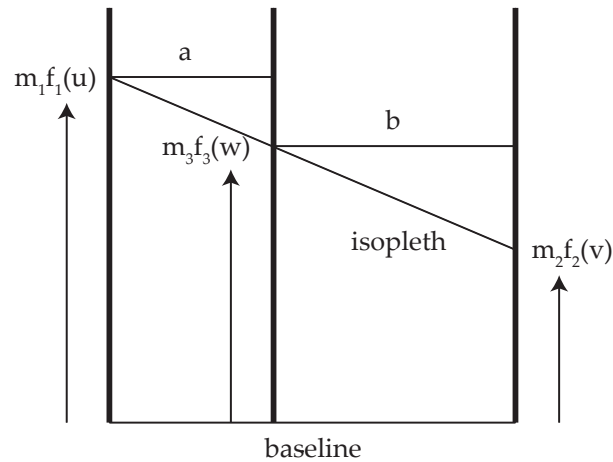

Figure 2. Derivation for a parallel-scale nomogram.

Each function is plotted on a vertical scale using a corresponding scaling factor (sometimes called a *scale modulus*)— $m_1$ ,  $m_2$ , or  $m_3$ —that provides a conveniently-sized nomogram. The diagonal line represents the straight-edge solution of the nomogram and is called an *index line* or *isopleth*. By similar triangles,

$$\frac{m_1 f_1(u) - m_3 f_3(w)}{a} = \frac{m_3 f_3(w) - m_2 f_2(v)}{b},$$

$$m_1 f_1(u) + (a/b)m_2 f_2(v) = (1 + a/b)m_3 f_3(w).$$

To arrive at the original equation  $f_1(u) + f_2(v) = f_3(w)$ , we cancel out all the terms involving  $m$ ,  $a$ , and  $b$ , which is accomplished by setting

$$m_1 = (a/b)m_2 = (1 + a/b)m_3.$$

The left two terms of this relationship determine the relative scaling of the two outer scales, and the third term provides the scaling of the middle scale as

$$\frac{m_1}{m_2} = \frac{a}{b}, \quad m_3 = \frac{m_1 m_2}{m_1 + m_2}.$$

The baseline does not have to be perpendicular to the scales for the similar-triangle proportion to be valid.

We have  $a = b$  for the case where the middle scale is located halfway between the outer scales, and in this case  $m_1 = m_2$  and  $m_3 = m_1/2$ . For a small outer scale, we can change its scaling factor  $m$  to increase its length, which shifts the middle line toward the other outer scale. In fact, if the unknown scale  $w$  has a very small range, it can be moved outside of the two other scales to lengthen it.

Additions to  $u$ ,  $v$ , or  $w$  simply shift the scale values up or down. Multipliers of  $u$ ,  $v$ , and  $w$  multiply the value when drawing the scales (they are not included in the values of  $m$  in the above calculations). Negating a variable simply reverses the up/down direction of that scale; and if two variables are negated, their scales can simply be swapped.

This looks like a lot of work to create a nomogram to solve a simple linear equation. But in fact plotting logarithmic rather than linear scales expands the use of parallel-scale nomograms to very complicated equations! The use of logarithms allows multiplications to be represented by additions and powers to be represented by multiplications:  $\log cd = \log c + \log d$  and  $\log c^d = d \log c$ . So an equation such as  $f_1(u) \times f_2(v) = f_3(w)$  can be converted to  $\log f_1(u) + \log f_2(v) = \log f_3(w)$  and plotted as a parallel-scale nomogram with logarithmic scales.

Let's create a nomogram for the equation

$$(1.2D + 0.47)^{0.68}(0.91T)^{3/2} = N$$

as shown in **Figure 3**. We assume that the engineering ranges that we are interested in are  $1.0 < D < 8.0$  and  $1.0 < T < 2.0$ .

We first convert the equation to logarithmic form as

$$0.68 \log(1.2D + 0.47) + 1.5 \log T = \log N - 1.5 \log 0.91.$$

We will plot  $D$ ,  $T$ , and  $N$  from our formulas above for  $u$ ,  $v$  and  $w$ . To find the scaling factors, we divide the final desired height of the  $D$ - and  $T$ -scales (say, 11 in. for both) by their ranges (maximum – minimum).

$$m_1 = \frac{11}{0.68 \log[1.2(8.0) + 0.47] - 0.68 \log[1.2(1.0) + 0.47]} = 20.73,$$

$$m_2 = \frac{11}{1.5 \log 2.0 - 1.5 \log 1.0} = 24.36,$$

$$m_3 = \frac{m_1 m_2}{m_1 + m_2} = 11.20.$$

Let's set the width of the chart to 6 in.:

$$\frac{a}{b} = \frac{m_1}{m_2} = 0.851, \quad a = 0.851b;$$

$$a + b = 6, \quad 0.851b + b = 6;$$

yielding  $b = 3.241$  in.,  $a = 2.759$  in.

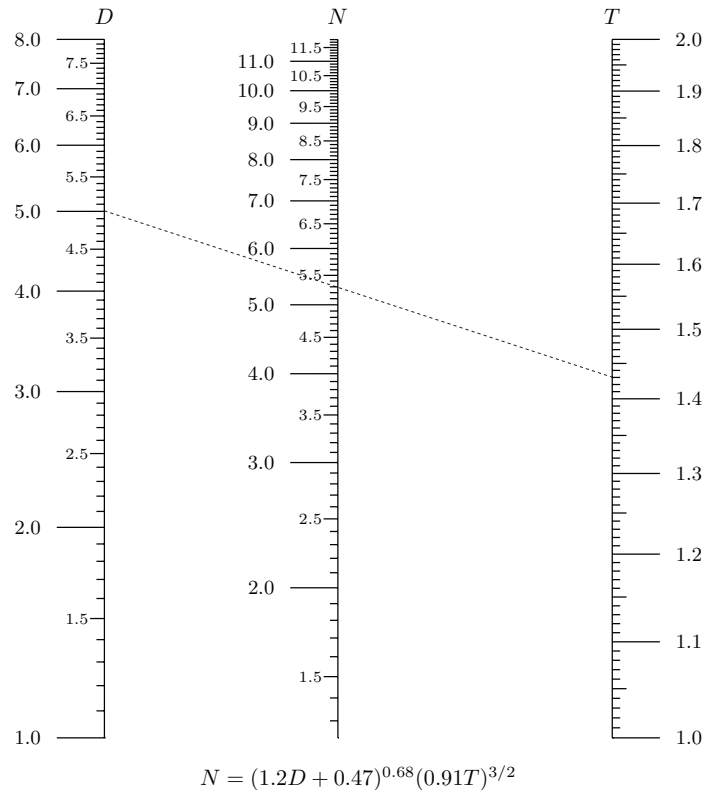

**Figure 3.** A parallel-scale nomogram for a nonlinear equation.

We draw the  $D$ -scale on the left with a baseline value of 1.0 and tickmarks spaced out as

$$20.73 \times [0.68 \log(1.2D + 0.47) - 0.68 \log(1.2(1.0) + 0.47)],$$

which will result in an 11-in. scale. Then 6 in. to the right of it, we draw the  $T$ -scale with a baseline value of 1.0 and tickmarks spaced out as

$$24.36(1.5 \log T - 1.5 \log 1.0).$$

Finally, 2.759 in. to the right of the  $D$ -scale (a bit left of center), we draw the  $N$ -scale with a baseline of

$$[1.2(1.0) + 0.47]^{0.68} [0.91(1.0)]^{1.5} = 1.230$$

and tickmarks spaced out as  $11.20[\log N - 1.5 \log(0.91)]$ .

We arrive at the nomogram in **Figure 3**, where a straightedge connecting values of  $D$  and  $T$  crosses the middle scale at the correct solution for  $N$ . In fact, any two of the variables will produce the third. This is a surprising feature of nomograms: They can calculate a solution for a variable that might be impossible to isolate algebraically. The result here is a deceptively simple diagram for solving a fairly complicated equation.<sup>1</sup>

<sup>1</sup>Most nomograms in this article were drawn with the PyNomo open-source software, available free from <http://www.pynomo.org>.

## N or Z Charts

A nomogram such as in **Figure 4** is called an *N chart* or *Z chart* because of its shape. The slanting middle scale joins the baseline values of the two outer scales (which now run in opposite directions). The middle line can slant in either direction by flipping the diagram, and it can be just a partial section anchored at one end or floating in the middle if the entire scale is not needed in the problem, thus appearing, as Douglass [1947] puts it, “rather more spectacular” to the casual observer. An N chart can be used to solve a three-variable equation involving a division:

$$f_3(w) = \frac{f_1(u)}{f_2(v)}.$$

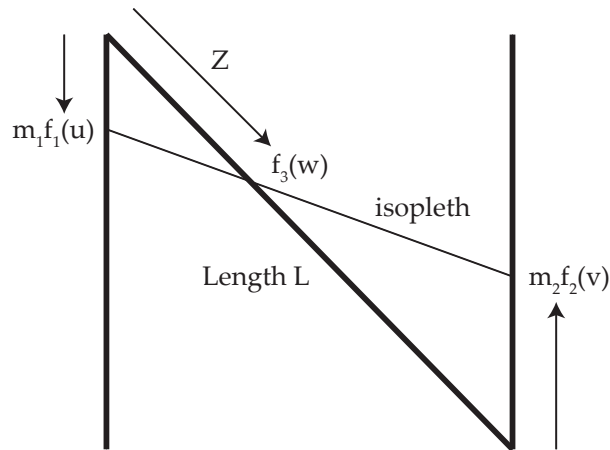

**Figure 4.** Derivation for an N chart.

By similar triangles,

$$\frac{m_1 f_1(u)}{m_2 f_2(v)} = \frac{Z}{L - Z}.$$

Substituting  $f_3(w)$  for  $f_1(u)/f_2(v)$  and rearranging terms yields the distance along the diagonal for tickmarks corresponding to  $f_3(w)$ :

$$Z = \frac{L f_3(w)}{(m_2/m_1) + f_3(w)}.$$

The  $f_3(w)$ -scale does not have a uniform scaling factor  $m_3$  as before. We could have designed a parallel-scale nomogram with logarithmic scales to plot this division, but the N chart performs this with linear scales for  $u$  and  $v$  and it was once a real chore to create logarithmic scales. Also, the outer scales of the N chart sometimes need to be linear in order to attach additional scales in a compound nomogram with additional variables.

An example of an N chart is shown in **Figure 5** for the volume of a cylinder  $V = \pi r^2 h$ , where we arrange the formula in division form as

$$h = \frac{V/\pi}{r^2}.$$

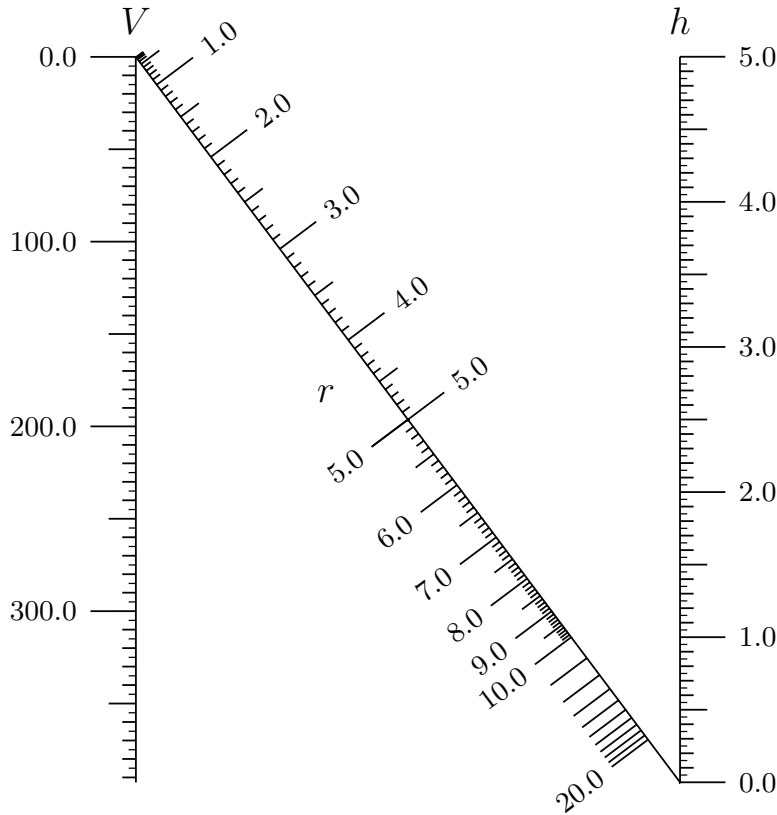

Volume of a Cylinder:  $V = \pi r^2 h$

**Figure 5.** An N chart for the volume of a cylinder.

For  $0 < V/\pi < 125$ ,  $0 < r < 5$ ,  $0 < h < 5$ , and a 10-in.-high nomogram,  $m_1 = 10/125 = 0.08$  and  $m_2 = 10/25 = 0.4$ . For an 8-in. width, we find the length of the diagonal  $h$ -scale from  $L = \sqrt{8^2 + 10^2} = 12.806$ . Then the tickmarks for  $h$  are located a distance along the diagonal of

$$Z = \frac{12.806h}{0.4/0.08 + h}.$$

Finally, we multiply the  $V/\pi$ -scale values by  $\pi$  in order to plot  $V$ .

Much more complicated formulas are also easily accommodated. An N chart is often flipped so the diagonal runs in the opposite direction. It is also possible to slide the outer scales of an N chart up or down without changing the tickmark spacing of the  $Z$ -scale as it rotates due to its attached

ends (because similar triangles still result), producing a nomogram with a  $Z$ -scale perpendicular to the outer scales, as shown later in **Figure 16** on p. 475.

## Proportional Nomograms

The proportional chart solves an equation in four unknowns of the type

$$\frac{f_1(u)}{f_2(v)} = \frac{f_3(w)}{f_4(t)}. \quad (1)$$

If we take our earlier N chart diagram and add a second isopleth that intersects the  $Z$  line at the same point as the first, we have by similar triangles in **Figure 6**:

$$\frac{m_1 f_1(u)}{m_2 f_2(v)} = \frac{m_3 f_3(w)}{m_4 f_4(t)}.$$

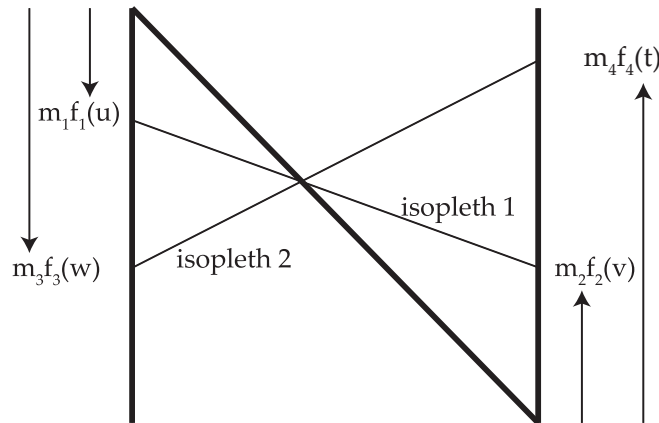

**Figure 6.** Derivation for a proportional nomogram.

This relation matches (1) if we choose the scaling of the outer scales such that

$$\frac{m_1}{m_2} = \frac{m_3}{m_4}.$$

We then overlay two variables on each outer scale with this ratio of scaling factors, as shown in **Figure 7** for the ideal gas law  $pV = nRT$  expressed as a proportion  $V/T = nR/p$ , where the constant  $R = 0.0821$  L-atm/mol-K. We design a 10-in.-tall nomogram for the ranges  $0 < V < 10$  ( $m_1 = 1.000$ ),  $0 < T < 353$  ( $m_2 = 0.0283$ ), and  $0 < nR < 0.1642$  ( $m_3 = 60.90$ ). We find  $m_4 = m_3 m_2 / m_1 = 1.725$ . Finally, we divide the  $nR$ -scale values by the constant  $R$  in order to plot  $n$  (and here the nomogram is reflected so that the diagonal runs in the opposite direction).



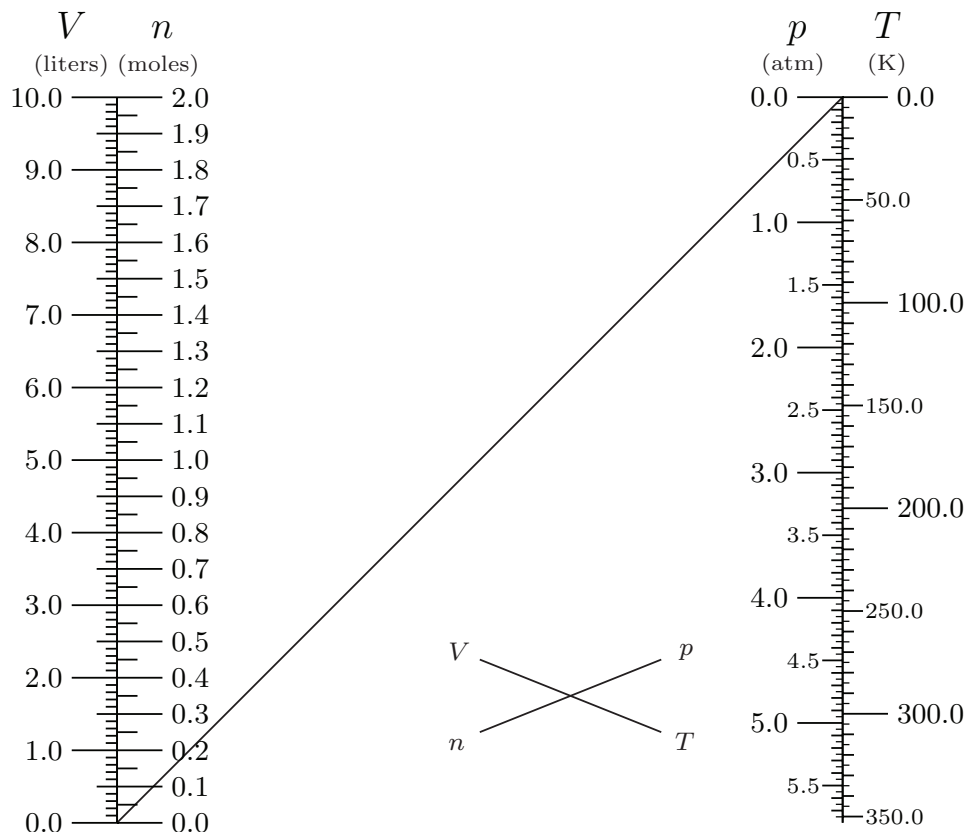

$$\text{Ideal Gas Law: } pV = nRT$$

Figure 7. A proportional nomogram for the ideal gas law.

Another type of proportional chart uses crossed lines within a boxed area, as shown in **Figure 8** for the law of sines of a triangle. Again, the scaling factors for the four variables are given by  $m_1/m_2 = m_3/m_4$ . As in the previous example, this nomogram contains a key demonstrating its use.

But there are other types of proportional charts, as shown in **Figure 9**.

- The first type derives from the previous example after a set of sides is bent at opposite angles, because similar triangles still exist for any parallelogram.
- In the next two types, the isopleth is drawn between two scale variables, then moved parallel until it spans the third variable value and the fourth unknown variable.
- In the last type, the second isopleth is drawn perpendicular rather than parallel to the first one, which is generally superior because a right angle (such as the corner of a sheet of paper) is much more common than parallel rulers.

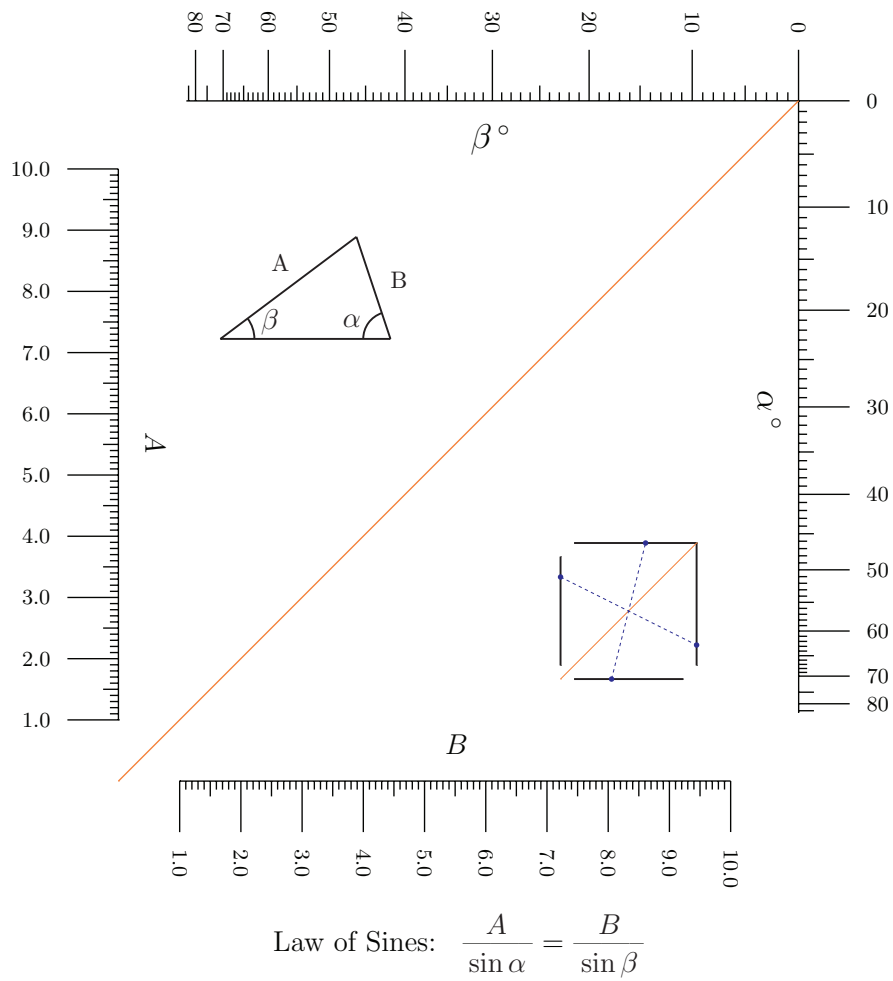

**Figure 8.** A proportional nomogram for the law of sines.

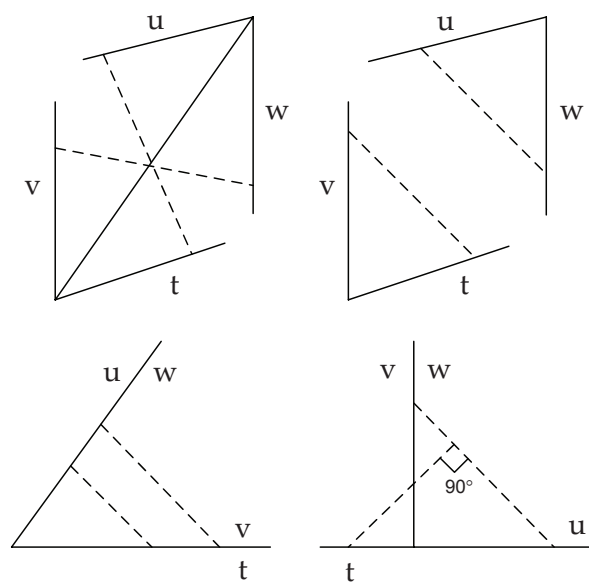

**Figure 9.** Additional designs for proportional nomograms (after Johnson [1952]).

### Concurrent-Scale Nomograms

The concurrent-scale nomogram solves an equation of the type

$$\frac{1}{f_1(u)} + \frac{1}{f_2(v)} = \frac{1}{f_3(w)}$$

The effective resistance of two parallel resistors is given by this equation, as are other problems such as capacitance and lens focal lengths in series.

A geometric exercise shows that the scaling factors for the scale arrangement of **Figure 10** must meet the following conditions:

$$m_1 = m_2 = \frac{m_3}{2 \cos A}$$

Here  $A$  is the angle between the  $u$ -scale and the  $w$ -scale and also the angle between the  $v$ -scale and the  $w$ -scale. The scaling factor  $m_3$  corresponds to the  $w$ -scale. The zeros of the scales must meet at the vertex. If the angle  $A$  is chosen to be  $60^\circ$ , then  $2 \cos A = 1$  and the three scaling factors are identical, as is the case in **Figure 10**. Often the angle  $A = 45^\circ$  is chosen, since a rectangular nomogram is a better fit on the printed page.

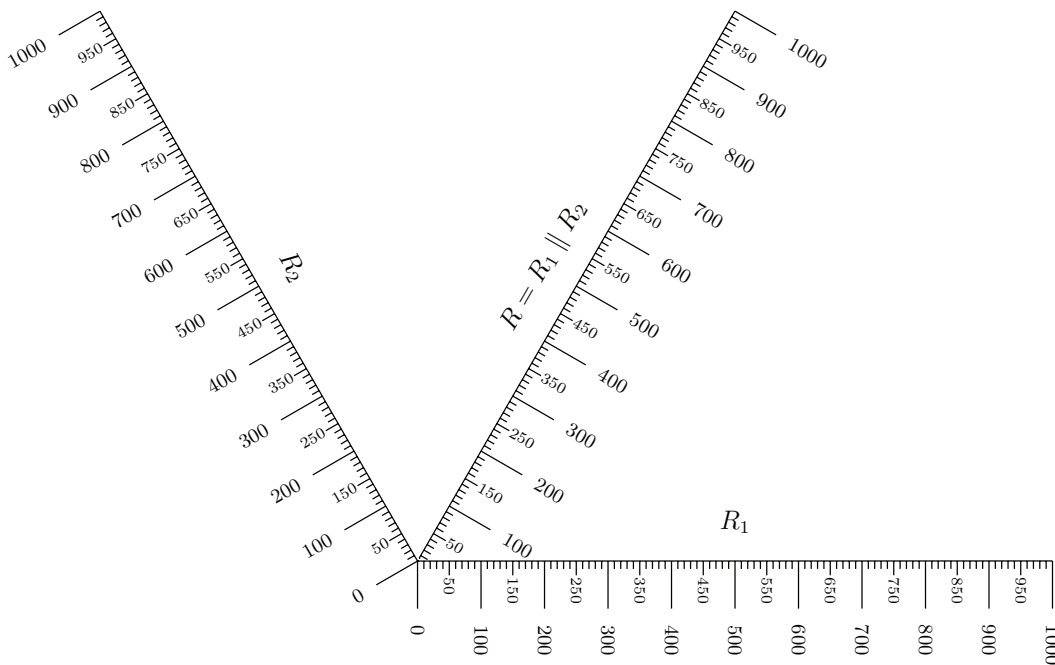

Equivalent Resistance of Two Resistors in Parallel

$$1/R = 1/R_1 + 1/R_2$$

**Figure 10.** A concurrent nomogram for two resistors in parallel.

### Compound Nomograms

A compound nomogram can solve an equation of four or more variables by concatenating a series of three-variable nomograms of any type.

The first step is to break the equation into parts in three variables that are equal to one another. The equation  $f_1(u) + f_2(v) + f_3(w) = f_4(t)$  can be rearranged as  $f_1(u) + f_2(v) = f_4(t) - f_3(w)$ . We create a new intermediate variable  $k$  to equal this latter quantity. We can draw a parallel-scale nomogram for  $f_1(u) + f_2(v) = k$  without marking scale values on the  $k$ -scale. Then a second parallel-scale nomogram for  $f_4(t) - f_3(w) = k$  is drawn using the same  $k$ -scale. The blank  $k$ -scale is called a *pivot line*, and often longer scales result when the pivot line is the middle scale of at least one of the nomograms. **Figure 11** shows such a compound parallel-scale nomogram for centripetal force  $F = mv^2/r$ .

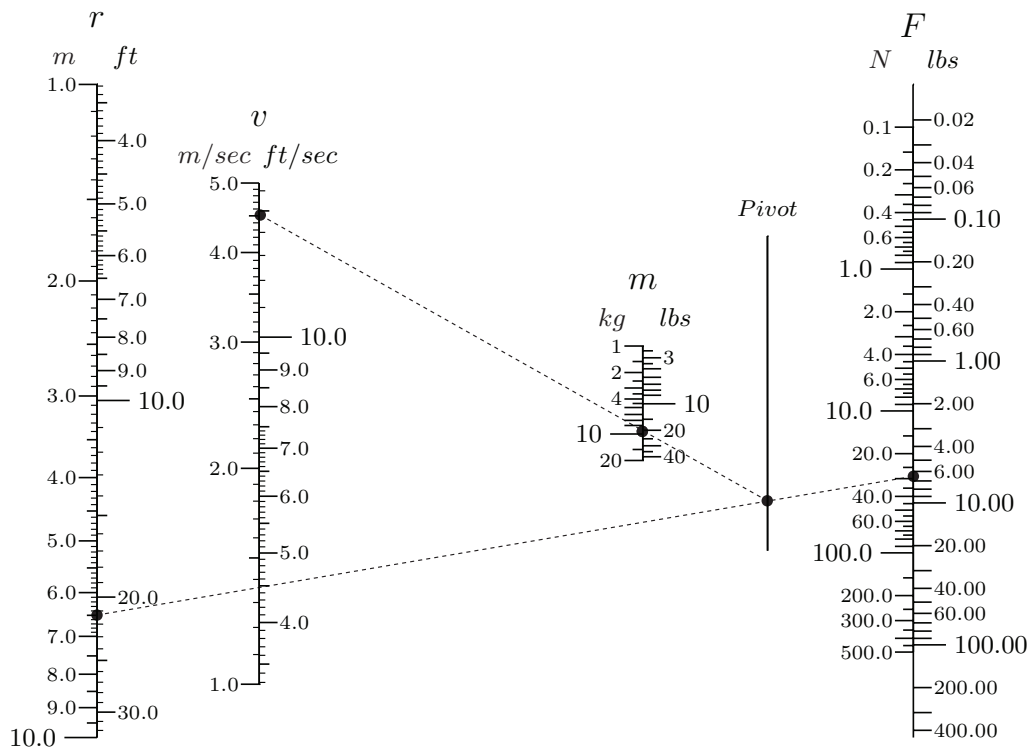

Centripetal Force:  $F = mv^2/r$

**Figure 11.** A compound parallel-scale nomogram for centripetal force.

To solve the 4-variable equation

$$1/f_1(u) + 1/f_2(v) + 1/f_3(w) = 1/f_4(t),$$

the equation is rearranged as

$$1/f_1(u) + 1/f_2(v) = 1/k, \quad 1/k + 1/f_3(w) = 1/f_4(t).$$

A compound nomogram for  $1/R_1 + 1/R_2 + 1/R_3 = 1/R$  is shown in **Figure 12**. The intermediate  $k$ -scale is labeled  $R_1 \parallel R_2$ , and the  $60^\circ$  angles used in this nomogram cause the  $R$ -scale ( $R_1 \parallel R_2 \parallel R_3$ ) to coincide with the  $R_2$ -scale. The original  $R_1$ -scale can be used for a fourth resistor in parallel. We can seesaw back and forth to add additional parallel resistors, and we can slide along the scales to add resistors in series.

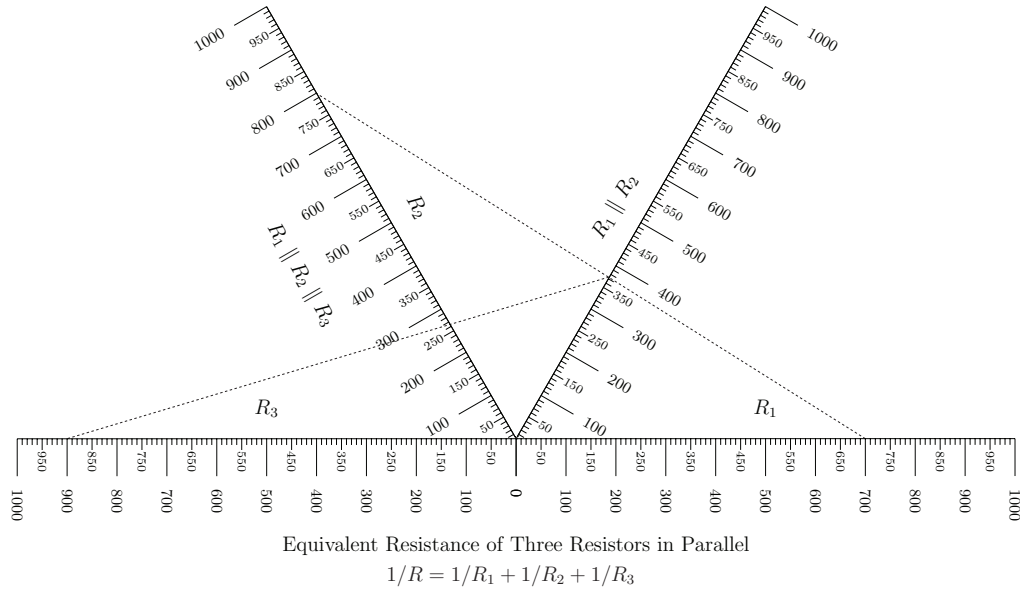

**Figure 12.** A concurrent nomogram for three resistors in parallel.

## Designing with Determinants

It happens that a brief knowledge of determinants offers a powerful way of designing very elegant and sophisticated nomograms, ones that contain curved scales or grids of scales. A determinant is denoted by vertical bars along the sides of a matrix of values or functions. The determinant of a  $3 \times 3$  matrix

$$\begin{pmatrix} a_{11} & a_{12} & a_{13} \\ a_{21} & a_{22} & a_{23} \\ a_{31} & a_{32} & a_{33} \end{pmatrix}$$

is denoted

$$\begin{vmatrix} a_{11} & a_{12} & a_{13} \\ a_{21} & a_{22} & a_{23} \\ a_{31} & a_{32} & a_{33} \end{vmatrix}$$

and is the quantity given by

$$a_{11}a_{22}a_{33} + a_{12}a_{23}a_{31} + a_{13}a_{21}a_{32} - a_{13}a_{22}a_{31} - a_{11}a_{23}a_{32} - a_{12}a_{21}a_{33}.$$

Two common methods of finding a determinant without memorizing this formula are shown in **Figure 13**:

- In the first method, the first two columns of the determinant are copied to the end and diagonals are drawn as shown. The products of the terms under each diagonal are added or subtracted as indicated to find the determinant.
- Alternatively, the determinant can be found by mentally wrapping the diagonals around to cross the needed terms, shown as the second method.

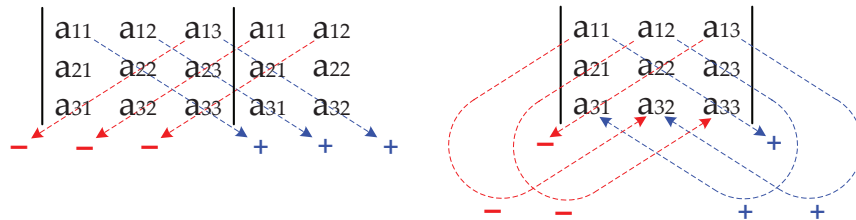

**Figure 13.** Two methods of finding a determinant.

There are just a few rules about manipulating determinants that we need to know. The first two are true for determinants in general, but the third and fourth apply only to determinants whose value is 0:

1. We can interchange any two rows or any two columns.
2. We can multiply or divide all the values in any row (or column) by a number (including 1) and add them to their corresponding values in another row (or column).
3. We can multiply or divide all the values in any row or column by a number. (Generally, the value of the determinant is multiplied or divided by that number, since every term has a member from each row and column; but because we will always work with determinants that are equal to zero, our determinants are unchanged.)
4. We can change the signs of all the terms in any row or column, for the same reason as above.

We will see later that there are some transformation operations that can also be applied to our determinants.

Now consider **Figure 14** showing three curvilinear scales and an isopleth. Similar-triangle relations give

$$\frac{y_3 - y_1}{x_3 - x_1} = \frac{y_2 - y_1}{x_2 - x_1} = \frac{y_3 - y_2}{x_3 - x_2}$$

Any two parts of this equation can be manipulated to the determinant expansion above and therefore we can write it as

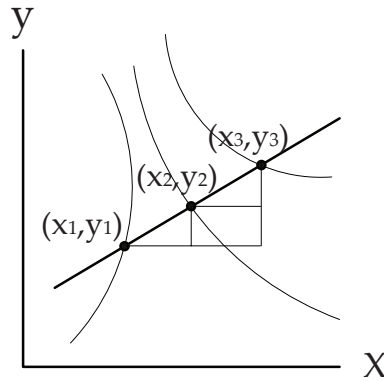

Figure 14. Similar triangle relations for three collinear points.

$$\begin{vmatrix} x_1 & y_1 & 1 \\ x_2 & y_2 & 1 \\ x_3 & y_3 & 1 \end{vmatrix} = 0.$$

The  $x$ - and  $y$ -elements can be interpreted as the  $x$ - and  $y$ -values of  $f_1(u)$ ,  $f_2(v)$ , and  $f_3(w)$ . To plot a three-variable nomogram from this determinant, we need to arrange terms so that

- each row involves only one variable (i.e.,  $x_1$  and  $y_1$  are functions of  $u$  only,  $x_2$  and  $y_2$  are functions of  $v$  only, and  $x_3$  and  $y_3$  are functions of  $w$  only);
- the last column is all 1s; and
- the determinant is the equation of the nomogram.

A determinant such as this is said to be in *standard nomographic form*. The  $u$ -scale is then plotted by the parametric functions in the first row, where the functions  $x_1$  and  $y_1$  are used to calculate the  $(x, y)$ -coordinate for each value of  $u$  on the scale.

For example, the determinant

$$\begin{vmatrix} 0 & u & 1 \\ 1 & -v^2 & 1 \\ w & w & 1 \end{vmatrix} = 0$$

expands to the equation  $uw + w + v^2w - u = 0$ , or  $w = u/(u + v^2 + 1)$  as an equation plotted as a nomogram. Here the  $x$ -coordinate of the  $u$ -scale is always 0, so the  $u$ -scale is a vertical scale at  $x = 0$  with  $y$ -values equal to the  $u$ -values over its range. The  $v$ -scale is a vertical scale at  $x = 1$  with  $y$ -values of  $-v^2$  over the range of  $v$ . The  $w$ -scale has  $x$ - and  $y$ -values equal to  $w$ , so it turns out to be a diagonal scale that passes through the origin if the range of the  $w$ -scale includes  $w = 0$ . The nomogram is plotted in **Figure 15** for positive values of the variables.

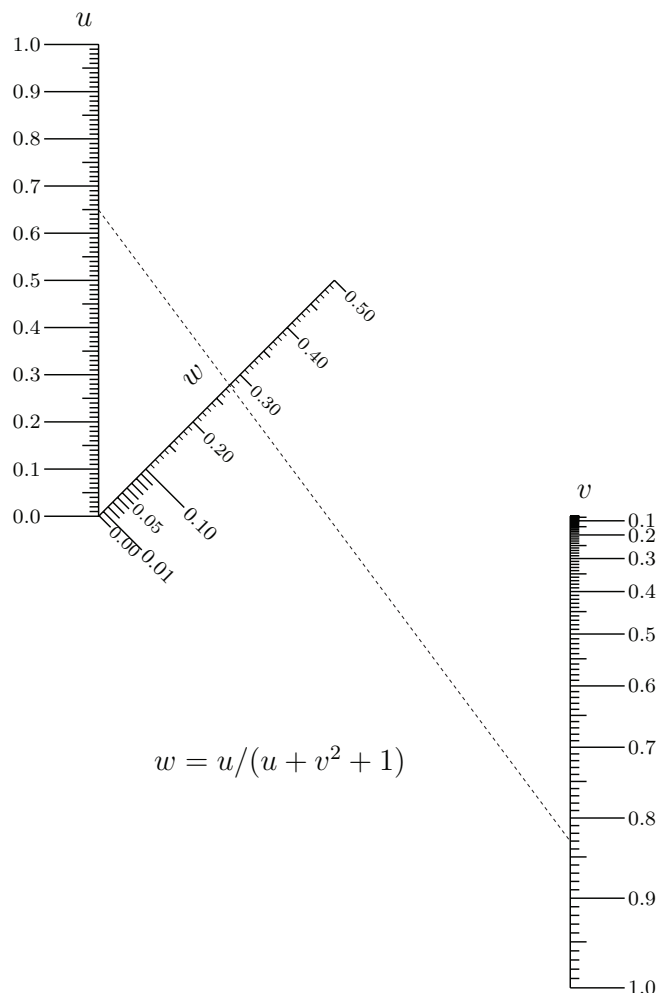

**Figure 15.** A nomogram for  $w = u / (u + v^2 + 1)$ .

### Straight-Scale Nomograms Using Determinants

On pp. 460–461, we created a parallel-scale nomogram for the equation  $(1.2D + 0.47)^{0.68}(0.91T)^{3/2} = N$  by using geometric relationships. We can express the logarithmic form of this as

$$0.68 \log(1.2D + 0.47) + 1.5 \log T - (\log N - 1.5 \log 0.91) = 0.$$

This is an equation of the form  $f_1(u) + f_2(v) - f_3(w) = 0$ , so let's find a determinant that produces this general form. Nomography books often suggest educated guesswork to fill in an initial determinant, which is kind of fun, but we'll use a consistent procedure. Nevertheless, converting this initial determinant to standard nomographic form still requires ingenuity. If we set  $A = f_1(u)$  and  $B = f_2(v)$ , then we have



$$\begin{aligned} A \times 1 + B \times 0 - f_1(u) &= 0 && \text{from } A = f_1(u), \\ A \times 0 + B \times 1 - f_2(v) &= 0 && \text{from } B = f_2(v), \\ A \times 1 + B \times 1 - f_3(w) &= 0 && \text{from } f_1(u) + f_2(v) - f_3(w) = 0. \end{aligned}$$

This set of simultaneous equations can be expressed in determinant form as

$$\begin{vmatrix} 1 & 0 & -f_1(u) \\ 0 & 1 & -f_2(v) \\ 1 & 1 & -f_3(w) \end{vmatrix} = 0.$$

This expression meets our criteria that the determinant produces the original equation and each row contains functions of only one variable. But we also want the flexibility to introduce scaling factors  $m_1$  and  $m_2$  for the  $u$ - and  $v$ -scales so they will fit our paper. We can add the scaling factors without changing the determinant as follows:

$$\begin{vmatrix} 1 & 0 & -m_1 f_1(u) \\ 0 & 1 & -m_2 f_2(v) \\ \frac{1}{m_1} & \frac{1}{m_2} & -f_3(w) \end{vmatrix} = 0.$$

Now we can use the rules for manipulating determinants to cast the determinant into standard nomographic form. Below are the results when we

- add the second column to the first [ $1/m_1 + 1/m_2 = (m_1 + m_2)/m_1 m_2$ ],
- multiply the third row by  $m_1 m_2 / (m_1 + m_2)$ , and then
- multiply the third column by  $-1$  and swap the columns around.

$$\begin{vmatrix} 1 & 0 & -m_1 f_1(u) \\ 1 & 1 & -m_2 f_2(v) \\ \frac{m_1 + m_2}{m_1 m_2} & \frac{1}{m_2} & -f_3(w) \end{vmatrix} = 0 \implies \begin{vmatrix} 1 & 0 & -m_1 f_1(u) \\ 1 & 1 & -m_2 f_2(v) \\ 1 & \frac{m_1}{m_1 + m_2} & -\frac{m_1 m_2}{m_1 + m_2} f_3(w) \end{vmatrix} = 0$$

$$\Rightarrow \begin{vmatrix} 0 & m_1 f_1(u) & 1 \\ 1 & m_2 f_2(v) & 1 \\ \frac{m_1}{m_1 + m_2} & \frac{m_1 m_2}{m_1 + m_2} f_3(w) & 1 \end{vmatrix} = 0.$$

Now the determinant is in standard nomographic form. The scaling factors of  $m_1$  and  $m_2$  result in a scaling factor for the  $w$ -scale of  $m_1 m_2 / (m_1 + m_2)$ , as we found earlier from our geometric derivation. We had calculated  $m_1 = 20.73$  and  $m_2 = 24.36$  before to make the  $u$ - and  $v$ -scales 11 in. long for the given ranges, giving  $m_3 = 11.20$ . This determinant also shows that we place the  $u$ -scale vertically at  $x = 0$  and the  $v$ -scale vertically at  $x = 1$ , with the  $w$ -scale at  $x = m_1 / (m_1 + m_2) = 0.4597$ ; but in fact we can multiply the first column by 6 to get a width of 6 in., and in that case the  $w$ -scale lies vertically at  $x = 2.759$  in., so we end up with *exactly* the same nomogram we found in **Figure 3** on p. 461 using geometric methods.

This was a bit of work, but we have found a universal determinant in standard nomographic form for the equation  $f_1(u) + f_2(v) - f_3(w) = 0$ , including scaling factors. In fact, a great deal of effort was exerted in the past to match particular forms of equations directly to standard nomographic determinant forms.

Let's derive an N chart for division using determinants. We can rearrange the equation  $w = u/v$  to  $u - vw = 0$ . We set  $A = u$  and  $B = v$  to get

$$\begin{aligned} A \times 1 + B \times 0 - u &= 0, \\ A \times 0 + B \times 1 - v &= 0, \\ A \times 1 - B \times w - 0 &= 0, \end{aligned}$$

$$\begin{vmatrix} 1 & 0 & -u \\ 0 & 1 & -v \\ 1 & -w & 0 \end{vmatrix} = 0.$$

One possible standard determinant that we can construct using our rules is

$$\begin{vmatrix} 0 & u & 1 \\ 1 & -v & 1 \\ \frac{w}{w+1} & 0 & 1 \end{vmatrix} = 0.$$

This is plotted as the nomogram in **Figure 16**. If we had specified ranges of  $u$  and  $v$  that included negative values, the nomogram would have appeared as a figure H, but here we see an N chart with a perpendicular middle line. We could use a shear transformation on our determinant as described later to yield an N chart with the more familiar angled middle scale, which allows longer scales for the same overall nomogram size.

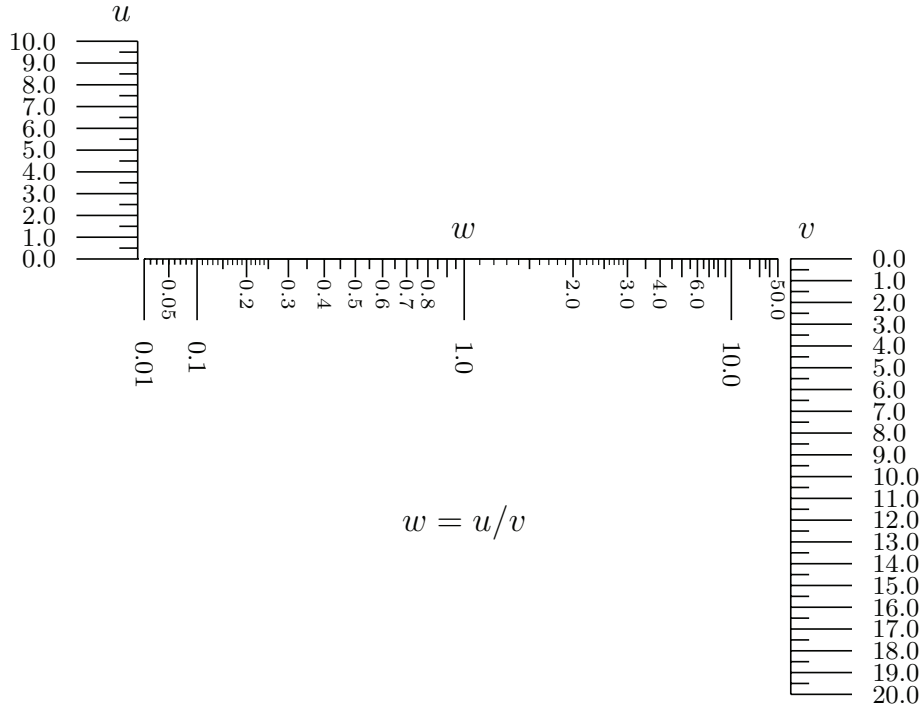

Figure 16. A nomogram for  $w = u/v$ .

### Curved-Scale Nomograms Using Determinants

Determinants are most useful when one or more of the  $u$ -,  $v$ -, and  $w$ -scales is curved. The quadratic equation  $w^2 + uw + v = 0$  can be represented as the first determinant below, and with the determinant rules we can arrive at the standard nomographic form shown in the second determinant [Adams 1964; Otto 1963]:

$$\begin{vmatrix} 1 & 0 & -u \\ 0 & 1 & -v \\ w & 1 & w^2 \end{vmatrix} = 0 \quad \implies \quad \begin{vmatrix} -u & 1 & 1 \\ v & 0 & 1 \\ \frac{w^2}{w-1} & \frac{w}{w-1} & 1 \end{vmatrix} = 0.$$

The  $u$ -scale runs linearly in the negative direction along the line  $y = 1$ . The  $v$ -scale runs linearly in the positive direction with the same scale along the line  $y = 0$ . These are shown in **Figure 17**, in which the positive root  $w_1$  of the quadratic equation can be found on the curved scale (the other root is  $u + w_1$ ).

A similar curved-scale nomogram is given in **Figure 18** for the equation  $M = (T - N)/T^2$ , or  $MT^2 - T + N = 0$ . This can be readily cast as the first determinant below and then manipulated into standard nomographic

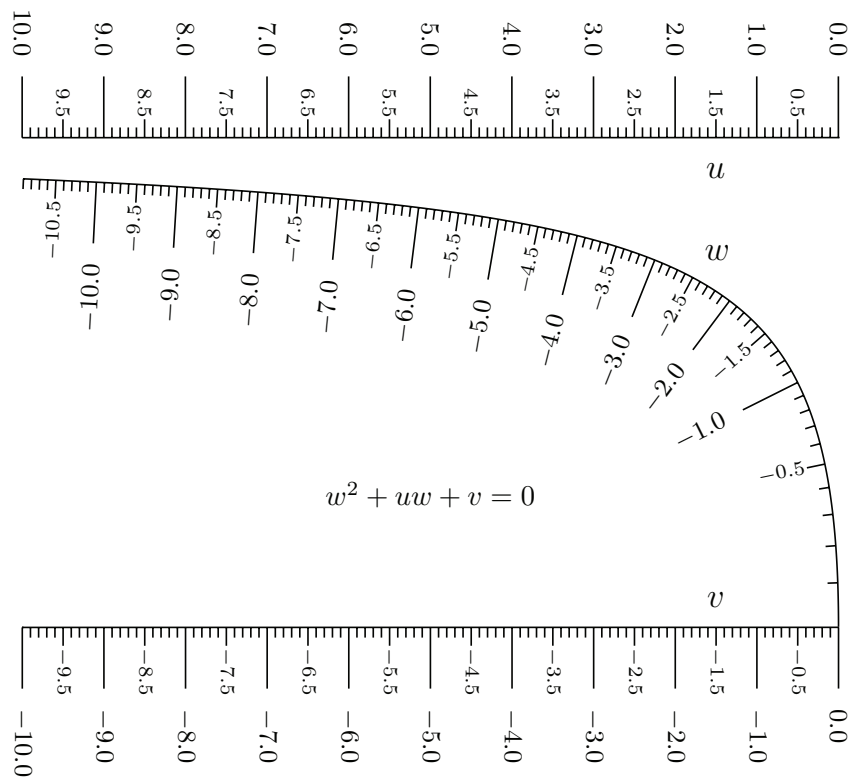

**Figure 17.** A curved-scale nomogram for solving a quadratic equation (after Adams [1964] and Otto [1963]).

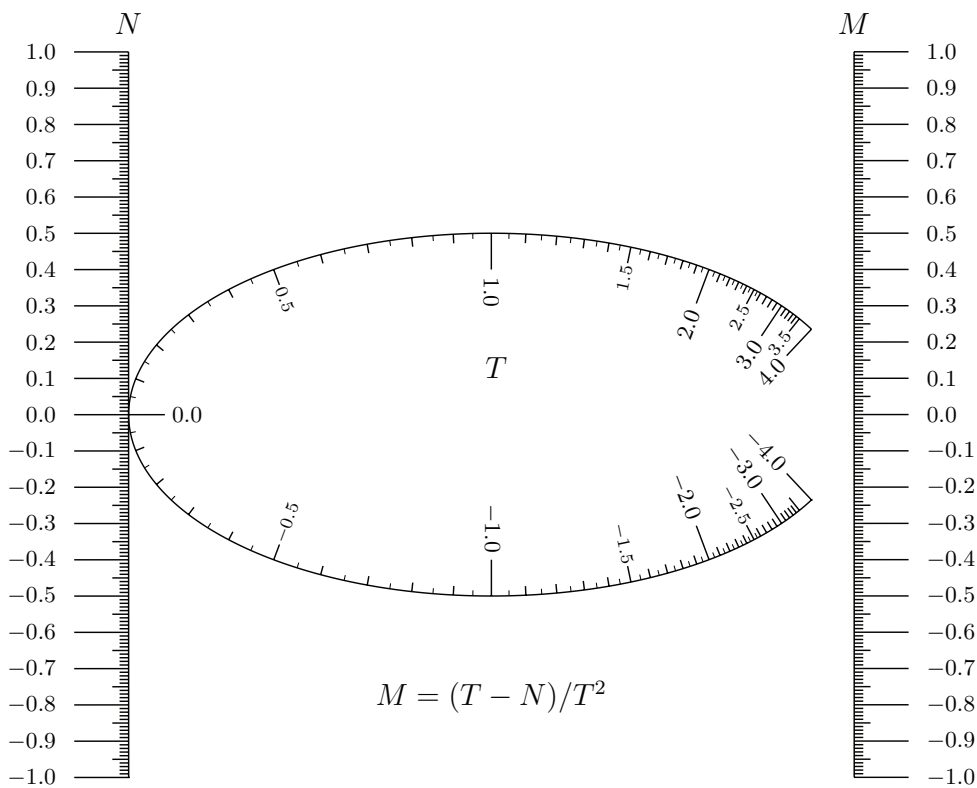

**Figure 18.** A curved-scale nomogram.

form as the second:

$$\begin{vmatrix} T^2 & 1 & -T \\ 1 & 0 & -M \\ 0 & 1 & -N \end{vmatrix} = 0 \quad \implies \quad \begin{vmatrix} 0 & N & 1 \\ \frac{T^2}{T^2+1} & \frac{T}{T^2+1} & 1 \\ 1 & M & 1 \end{vmatrix} = 0.$$

It's possible to have two or three curved scales, depending on how the determinant works out, and it is possible to have two or all three curves overlap exactly. The equation for the velocity of water flowing from a rectangular opening in a vertical wall is

$$v = \frac{2}{3} \sqrt{2g} \left( \frac{h_1^{3/2} - h_2^{3/2}}{h_1 - h_2} \right).$$

We can write this in metric units as  $0.338vh_1 - 0.338vh_2 - h_1^{3/2} + h_2^{3/2} = 0$ , and we can verify that this equation is equivalent to the first determinant equation below. Dividing the left column by  $h_1h_2$  and swapping rows provides the form plotted in **Figure 19** [Soreau 1902].

$$\begin{vmatrix} h_1 & h_2^{1/2} & 1 \\ 0 & 0.338v & 1 \\ h_2 & h_1^{1/2} & 1 \end{vmatrix} = 0 \quad \implies \quad \begin{vmatrix} 0 & 0.338v & 1 \\ \frac{1}{h_1} & h_1^{1/2} & 1 \\ \frac{1}{h_2} & h_2^{1/2} & 1 \end{vmatrix} = 0.$$

Here the  $h_1$ - and  $h_2$ -scales lie exactly on the same curve. They could have separate tickmarks on this curve if they had different scales, but here they have the same scaling factor. Actually, the two sides of the scales are used for different ranges for greater versatility; so  $v$ ,  $h_1$ , and  $h_2$  should use either the left or right sides of the scales but not both. It also turns out that if there is a solution  $(v, h_1, h_2)$ , then there is also a solution  $(kv, k^2h_1, k^2h_2)$  for any  $k$ . This feature increases the range and also allows us to move (if needed) into an area of the curve that is not as flat between our  $h_1$ - and  $h_2$ -values. In fact, the  $h_1$ - and  $h_2$ -values are four times as large in the second range, and the  $v$  values are twice as large, for this reason.

Otto [1963] provides an interesting alternate determinant for the equation  $f_1(u) + f_2(v) + f_3(w) = f_1(u)f_2(v)f_3(w)$ :

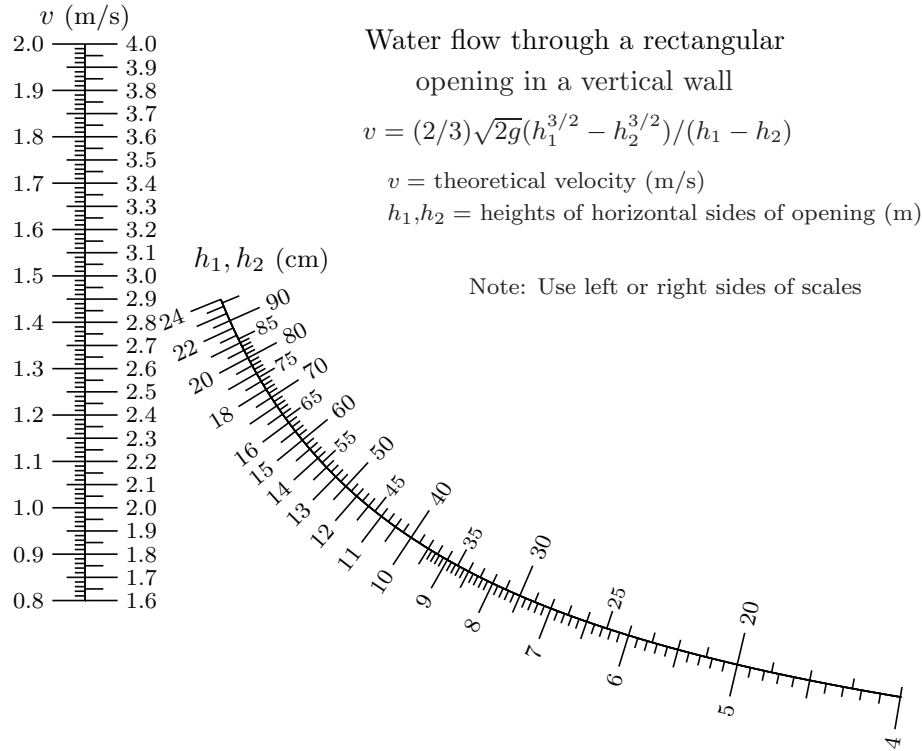

**Figure 19.** A nomogram for the water flow through a rectangular opening in a vertical wall (after Soreau [1902]).

$$\begin{vmatrix} \frac{2}{f_1(u)^2 + 4} & \frac{f_1(u)}{f_1(u)^2 + 4} & 1 \\ \frac{2}{f_2(v)^2 + 4} & \frac{f_2(v)}{f_2(v)^2 + 4} & 1 \\ \frac{2}{3} & \frac{1}{3f_3(w)} & 1 \end{vmatrix} = 0.$$

The nomogram for the particular equation of this type  $u + v + w = uvw$  is shown in **Figure 20**, where again two of the three scales overlap.

There is a very interesting determinant that can be created for the equation  $f_1(u)f_2(v)f_3(w) = 1$  [Otto 1963]:

$$\begin{vmatrix} \frac{-f_1(u)}{f_1(u)^3 - 1} & \frac{-f_1(u)^2}{f_1(u)^3 - 1} & 1 \\ \frac{-f_2(v)}{f_2(v)^3 - 1} & \frac{-f_2(v)^2}{f_2(v)^3 - 1} & 1 \\ \frac{-f_3(w)}{f_3(w)^3 - 1} & \frac{-f_3(w)^2}{f_3(w)^3 - 1} & 1 \end{vmatrix} = 0.$$

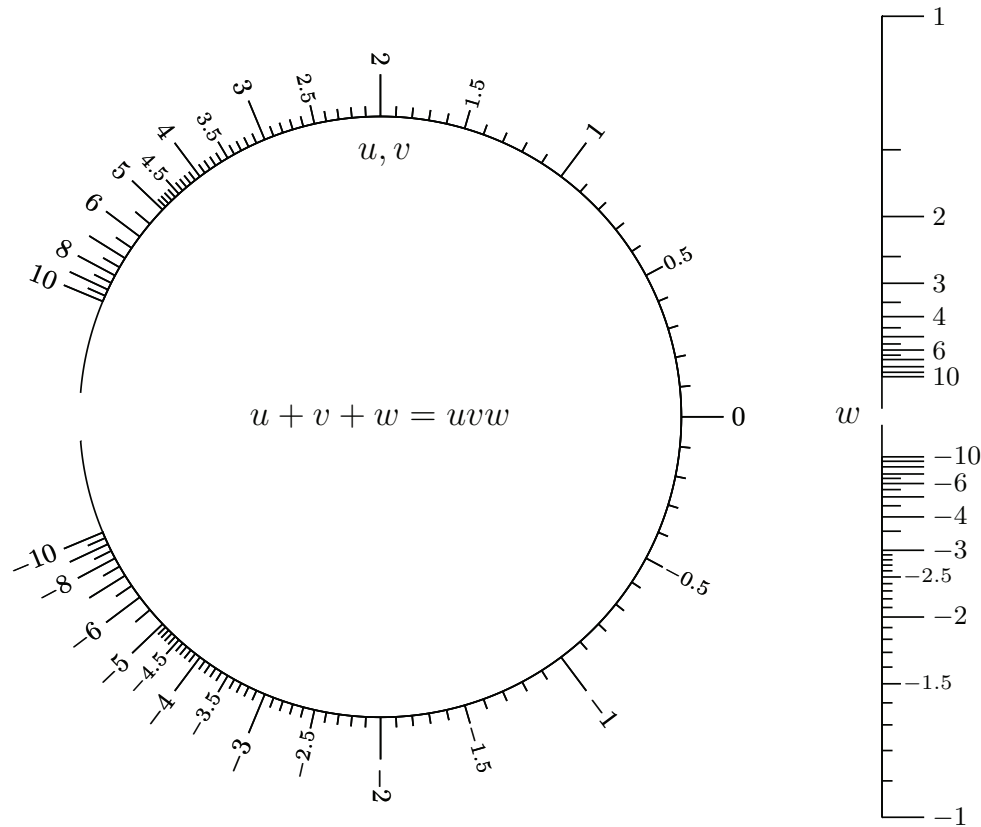

Figure 20. A nomogram for  $u + v + w = uvw$  (after Otto [1963]).

For  $uvw = 1$ , all three scales coincide and have the same scaling factor, and it turns out that the equation for this curve is  $x^3 + y^3 - xy = 0$  (called the *folium of Descartes*). This nomogram is shown in Figure 21.

### Grid Nomograms Using Determinants

A single, non-compound nomogram for an equation of 4 to 6 variables can be created if the determinant in standard nomographic form contains functions of no more than two variables per row. The single scale for a one-variable row is replaced by a grid of scales for values of each of the two variables, resulting in a *grid nomogram*.

### Celestial Observations

For example, consider the astronomical relationship between the azimuth  $Z$  and declination  $D$  of a celestial body, the latitude  $L$  of an observer, and the altitude  $H$  of the body as seen by the observer [Adams 1964; d’Ocagne 1899; Roschier and Makkonen 2009]:

$$\cos Z = \frac{\sin D - \sin H \sin L}{\cos H \cos L},$$

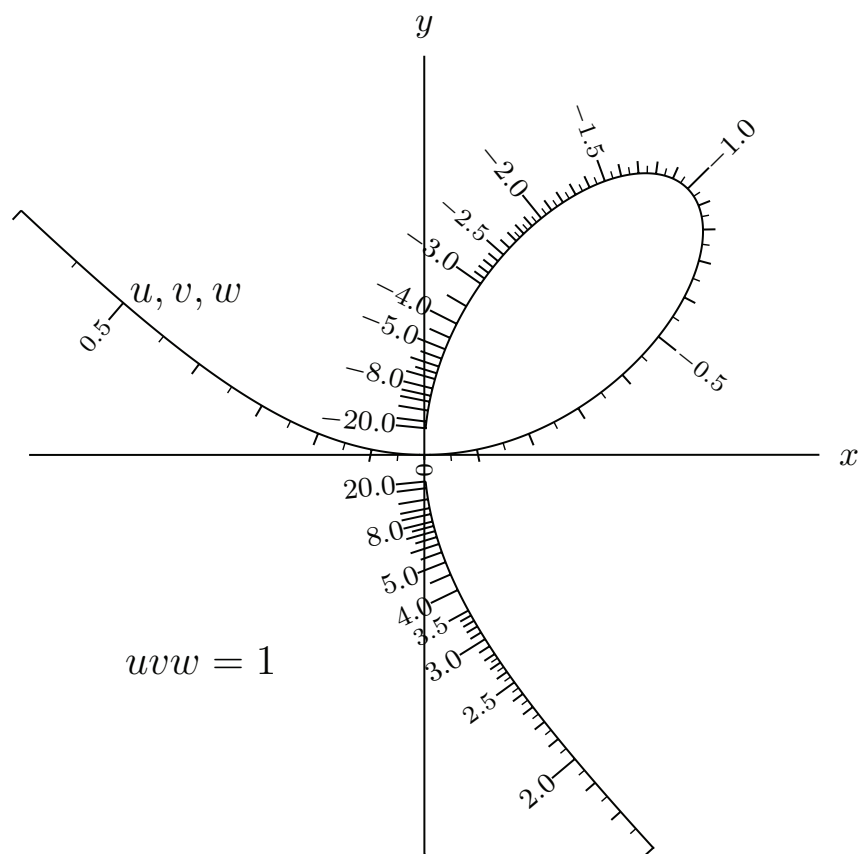

**Figure 21.** A nomogram in the form of the *folium of Descartes* for  $uvw = 1$  (after Otto [1963]).

or

$$\cos Z \cos H \cos L - \sin D + \sin H \sin L = 0.$$

Setting  $A = \cos Z$  and  $B = \sin D$ , we have

$$A \times 1 + N \times 0 - \cos Z = 0,$$

$$A \times 0 + B \times 1 - \sin D = 0,$$

$$A \times \cos H \cos L - B \times 1 + \sin H \sin L = 0,$$

and consequently

$$\begin{vmatrix} 1 & 0 & -\cos Z \\ 0 & 1 & -\sin D \\ \cos H \cos L & -1 & \sin H \sin L \end{vmatrix} = 0 \quad \Rightarrow$$



$$\Rightarrow \begin{vmatrix} 0 & \cos Z & 1 \\ \frac{1}{1 + \cos H \cos L} & \frac{-\sin H \sin L}{1 + \cos H \cos L} & 1 \\ 1 & -\sin D & 1 \end{vmatrix} = 0.$$

The nomogram for this equation is shown in **Figure 22**, where the intersection of the appropriate  $H$  and  $L$  curves serves as one scale value, with  $H = L$  corresponding to the point on the common curve along the envelope. The sample isopleth relates the values  $D = 10^\circ$ ,  $H = 65^\circ$ ,  $L = 30^\circ$ , and  $Z = 139.8^\circ$  or  $220.0^\circ$ . There are two possible values of  $Z$  for the same reason that the sun is at the same altitude twice a day, once in the morning and once in the afternoon. It turns out that the  $H$  and  $L$  curves on the grid are interchangeable except that  $H$  is always taken as positive.

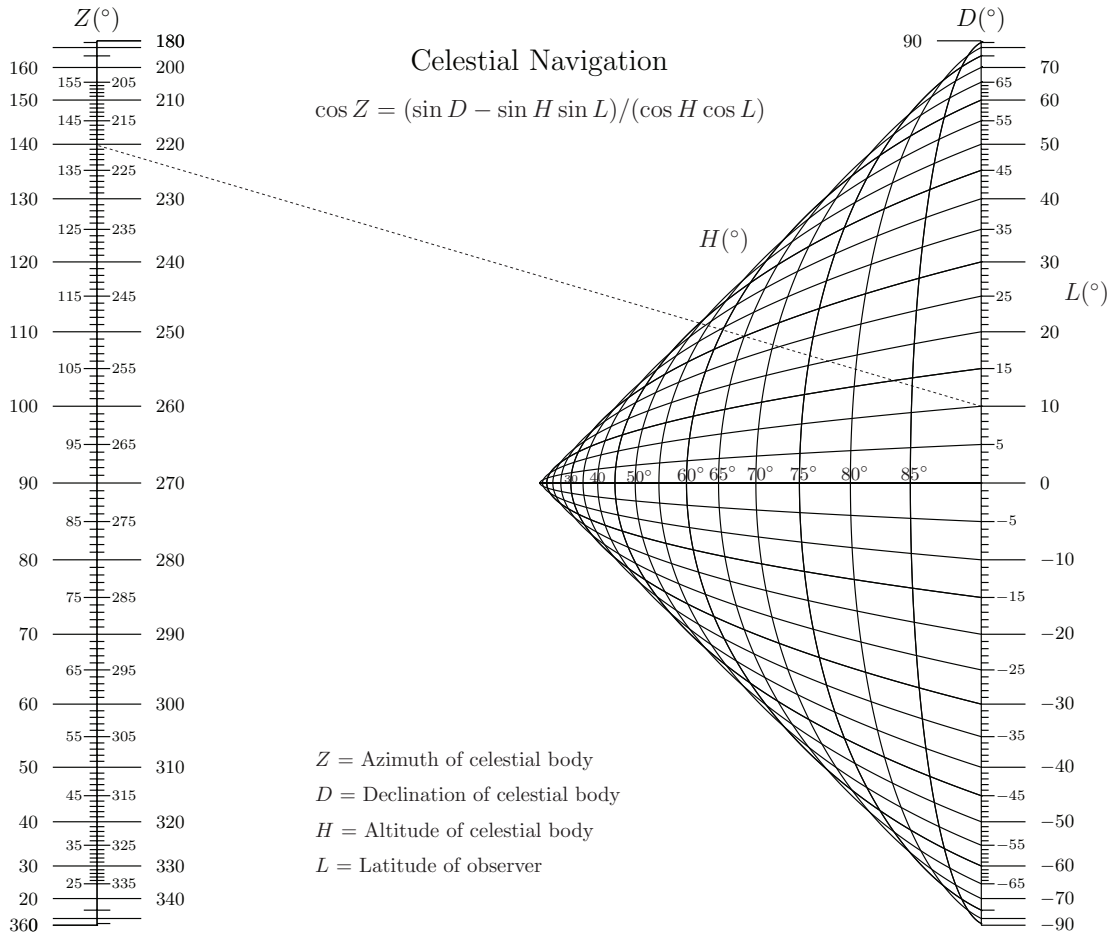

**Figure 22.** A grid nomogram for celestial navigation (after Adams [1964], d’Ocagne [1899], and Roschier and Makkonen [2009]).

### Trajectory of a Projectile

The trajectory of a projectile neglecting air friction can be represented by a grid nomogram [Hoelscher et al. 1958]. The relevant equation is

$$Y = X \tan A - \frac{gX^2}{2V_0^2 \cos^2 A},$$

where  $A$  is the initial angle,  $V_0$  is the initial velocity,  $Y$  is the height, and  $g$  is the acceleration due to gravity. Hoelscher derives the determinant and plots a family of curves for the nomogram of this equation, one for each value of  $A$ . However, we present it as a grid nomogram in **Figure 23** (with work done on scaling the  $x$ -axis and the  $y$ -axis to square up the output for the given ranges).

$$\begin{vmatrix} \frac{g}{2V_0^2} & 0 & 1 \\ Y & X & 0 \\ \tan A & 1 & \frac{X}{\cos^2 A} \end{vmatrix} = 0 \implies \begin{vmatrix} \frac{g}{2V_0^2} & 0 & 1 \\ Y & 1 & 1 \\ \frac{X \tan A \cos^2 A}{X^2 + \cos^2 A} & \frac{\cos^2 A}{X^2 + \cos^2 A} & 1 \end{vmatrix} = 0.$$

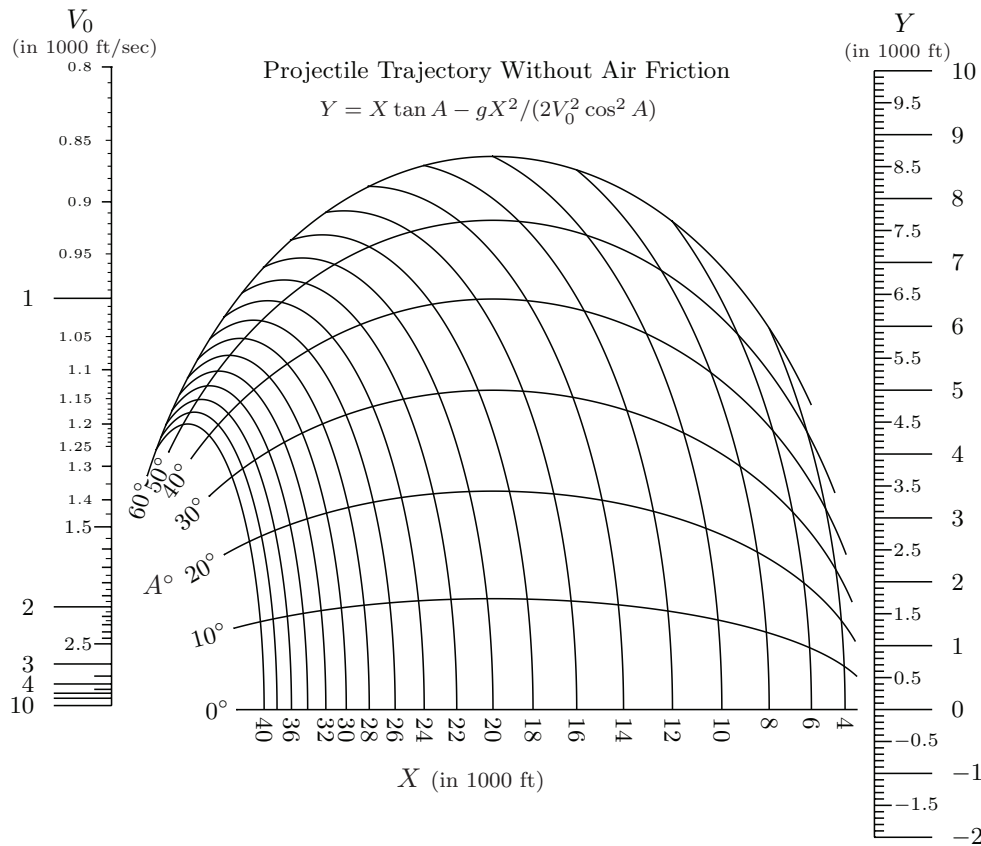

**Figure 23.** A grid nomogram for projectile trajectory neglecting air friction (after Hoelscher et al. [1958]).

## Transformations

In addition to producing sophisticated nomograms, the use of determinants offers one other major advantage. Often the scaling factors of variables have to be manipulated to get a nomogram that uses all the available area and yet stretches portions of the curves that are most in need of accuracy; alternatively, there may be a need to bring distant points (even at infinity) into a compact nomogram. This can be done by substitutions of the elements of the determinant or by multiplying the entire determinant by standard translation or rotation matrices. Let's look at the types of transformations that can be used for a nomogram.

### Translation

We can translate the nomogram by adding an offset to all elements in the  $x$  column or all elements in the  $y$  column of the determinant:

$$x_n \rightarrow x_n + c, \quad y_n \rightarrow y_n + d.$$

### Rotation

We can rotate the nomogram about the origin of the axes by an angle  $\theta$  (positive for counter-clockwise rotation) by replacing each element in the  $x$  column and each element in the  $y$  column with

$$x_n \rightarrow x_n \sin \theta + y_n \cos \theta, \quad y_n \rightarrow x_n \cos \theta - y_n \sin \theta.$$

### Stretch

We can stretch the nomogram by multiplying all elements in the  $x$  column or all elements in the  $y$  column of the determinant by a factor.

$$x_n \rightarrow cx_n, \quad y_n \rightarrow dy_n.$$

### Shear

A shear is a slewing of perpendicular axes to oblique axes or vice versa. This interpretation is perhaps best understood by referring to **Figure 24** showing a shear from one set of axes to another, in which the  $x'$ -axis is canted at an angle  $\theta$  to the  $x$ -axis but the  $y'$ -axis aligns with the  $y$ -axis. For this case,

$$x_n \rightarrow x_n \cos \theta, \quad y_n \rightarrow y_n + x_n \sin \theta.$$

**Figure 24** on the next page shows the effect of shearing the nomogram in **Figure 19** on p. 478. It turns out that a shear angle of  $\theta = 2.0^\circ$  lifts the tail of the curve for  $h_1$  and  $h_2$  and allows the  $v$ -scale to expand to the full height of the nomogram for greater precision of that scale. However, here we use  $\theta = 4.0^\circ$  to provide greater curvature of the tail for greater precision in  $h_1$  and  $h_2$ . Shear can also be used to convert a traditional N chart with a slanting middle line (as in **Figure 5** on p. 463) to one with a perpendicular middle line (as in **Figure 16** on p. 475) and vice versa.

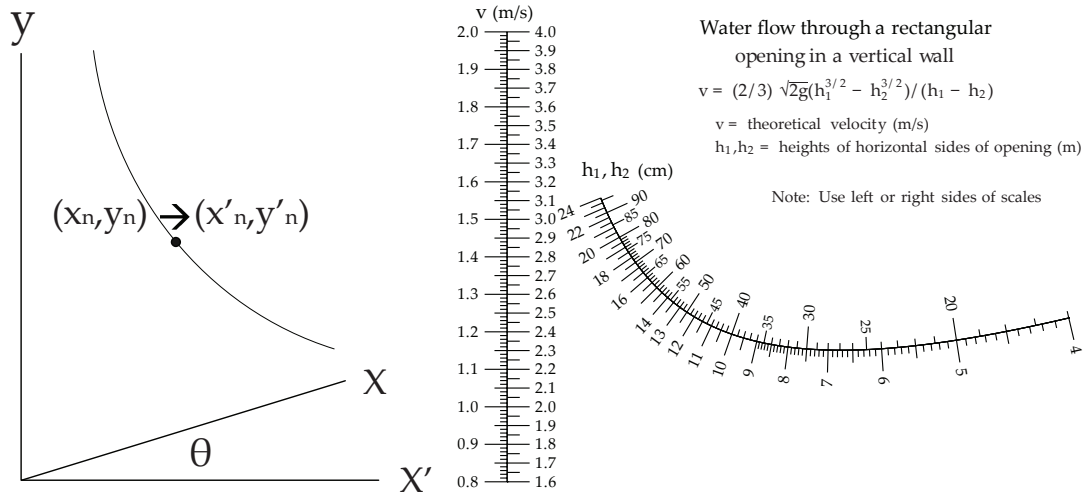

Figure 24. Shearing to an oblique  $x$ -axis and its effect on the nomogram in Figure 19.

### Projection

In Figure 25, a projection uses a point  $P$  (called the *center of perspectivity*) to project rays through points of a nomogram in the  $xy$ -plane to map them onto the  $yz$ -plane (also called the  $x'y'$ -plane), foreshortening or magnifying lines in varying amounts in the  $x'$  and  $y'$  directions.

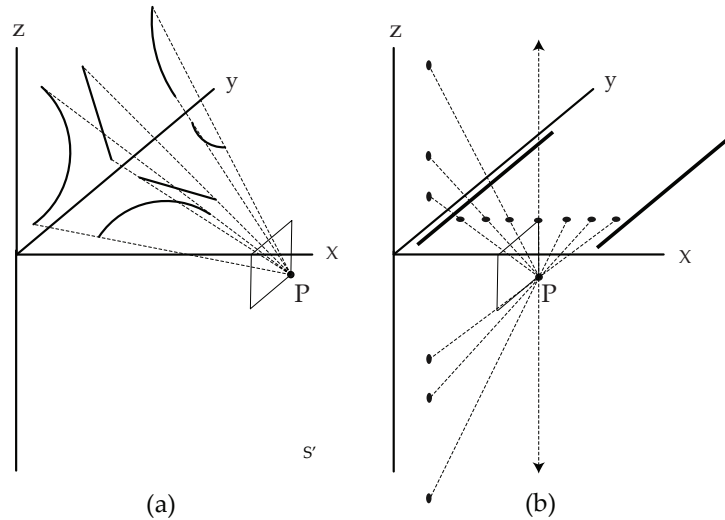

Figure 25. Projection onto the  $yz$ -plane through a point  $P$  a) not located under a nomogram and b) located under a scale.

In Figure 25a, the projection has the beneficial effect of increasing the size of the third scale to match that of the others. In Figure 25b, the point  $P$  is located beneath the nomogram; and it is apparent that points nearly above  $P$  are more widely separated than others in the projection, resulting in something of a magnifying-lens effect on that area of the nomogram. We can also see the curious effect of the center of the nomogram being

cast outside of the two outer scales. Projection can be used in either case to spread scales in areas of the nomogram for which greater accuracy is important, so it is a very important tool. For  $P$  at any location  $(x_P, y_P, z_P)$ , we have

$$x_n \rightarrow \frac{z_P x_n}{x_n - x_P}, \quad y_n \rightarrow \frac{y_P x_n - x_P y_n}{x_n - x_P}.$$

Looking back at our celestial navigation nomogram in **Figure 22** on p. 481, we see that the curves are quite crowded for lower altitudes  $H$  and latitudes  $L$ . A second nomogram for these ranges would be very beneficial. From our determinant for this nomogram (pp. 480–481), we glean that the pointed end of the grid lies at  $(0.5, 0)$ ; so if we place a projection point  $P$  at, say,  $(0.47, 0, -0.5)$ , we will magnify the area near the point to spread the scales out in that area for drawing finer divisions. The result of this projection is shown in **Figure 26**, where the grid now lies outside the other scales.

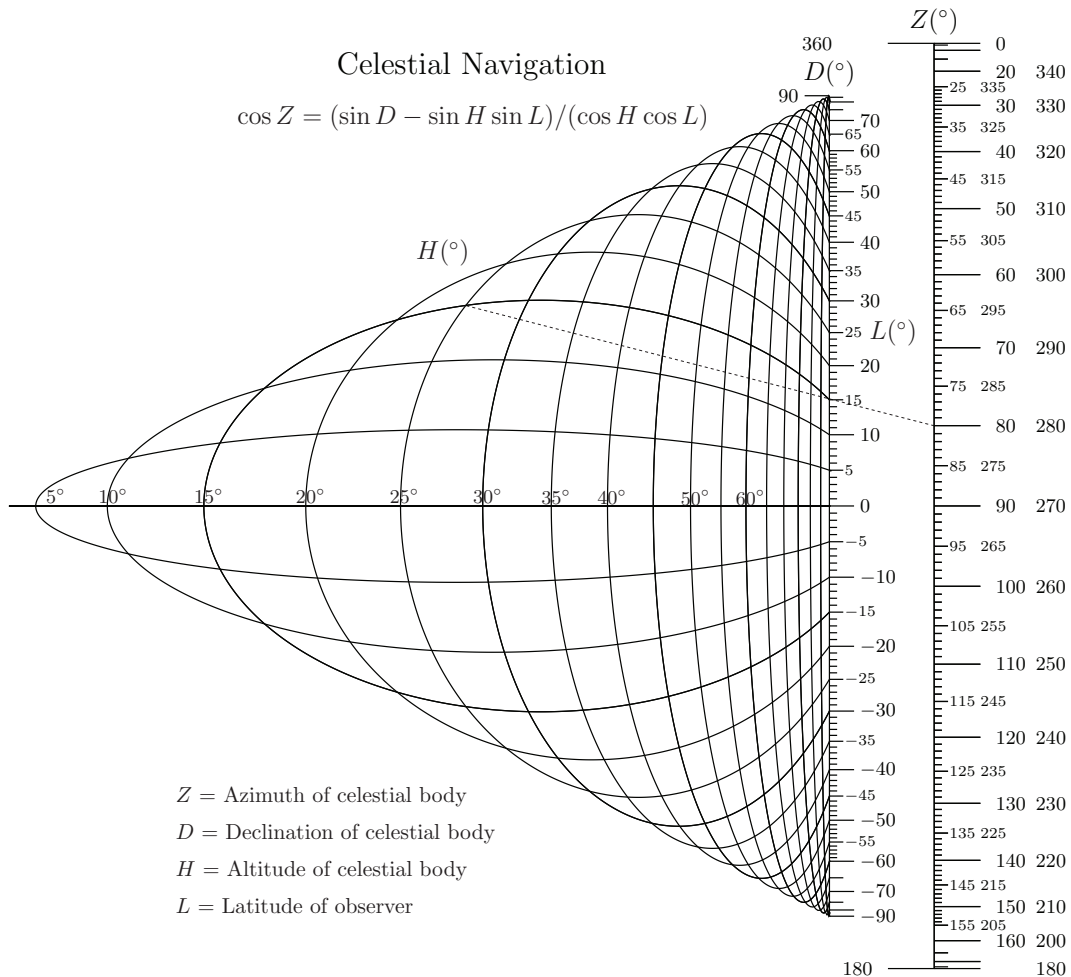

**Figure 26.** The celestial navigation nomogram from **Figure 22** after projection through the point  $(0.47, 0, -0.5)$ , providing greater accuracy for lower altitudes  $H$ .

**Figure 27** is a portion of the projectile trajectory nomogram of **Figure 23** on p. 482 after projection through  $P = (2, 0.5, -1)$  to magnify it for large distances  $X$ . The  $Y$ -scale is also extended to the more negative distances as required for the larger  $X$ . Points above  $P$  are projected to infinity, so only half of the nomogram is shown (the other half maps to the left of the vertical scales).

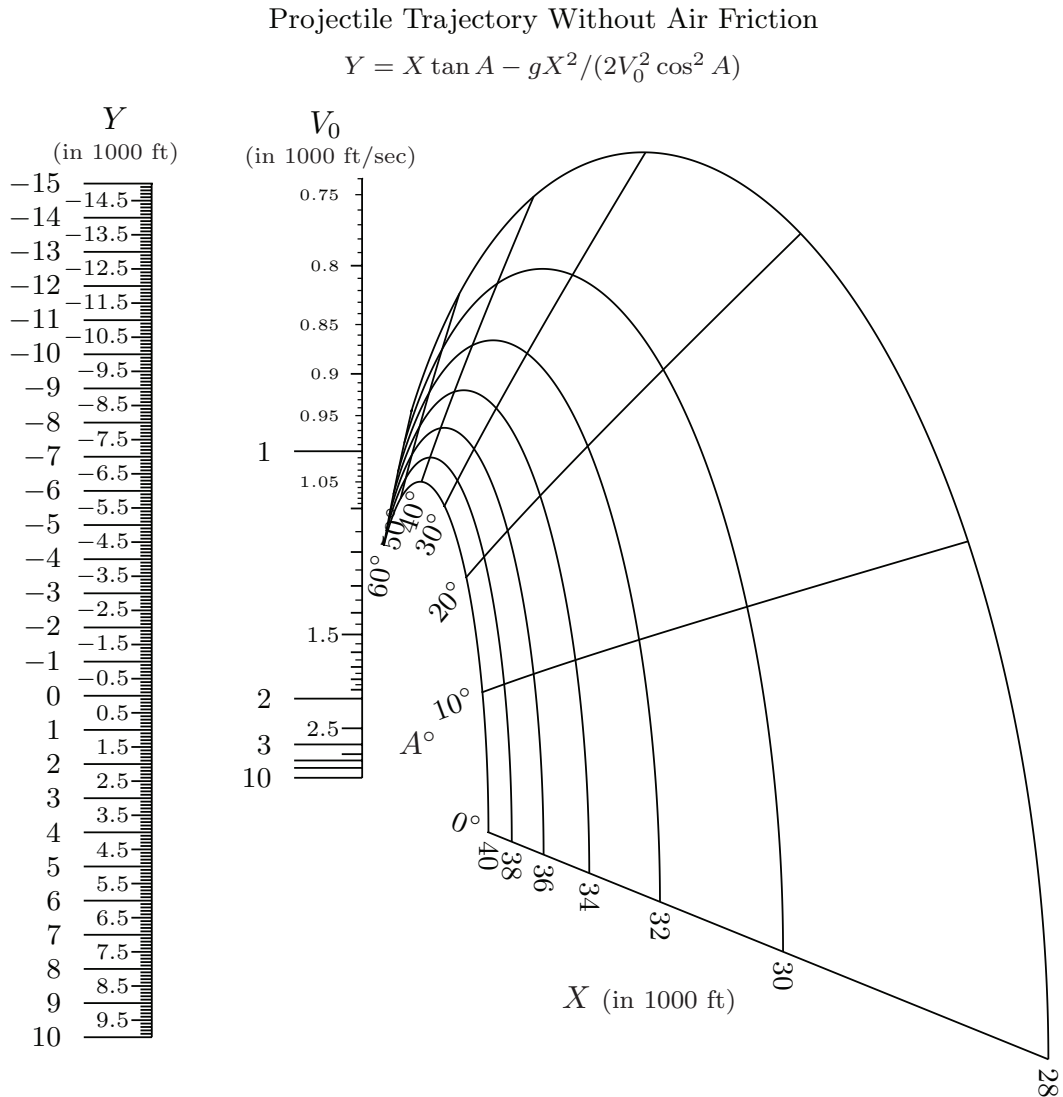

**Figure 27.** A portion of the projectile trajectory nomogram in **Figure 23** after projection through the point  $(2, 0.5, -1)$ , providing greater accuracy for longer distances  $X$ .

### A Transformation Exercise

Epstein [1958] suggests a transformation exercise for the reader that we will undertake. A determinant representing the equation  $q^2 - aq + b = 0$  can be constructed as

$$\begin{vmatrix} \frac{q}{q^{-1}} & \frac{q^2}{q^{-1}} & 1 \\ 1 & a & 1 \\ 0 & b & 1 \end{vmatrix} = 0.$$

This nomogram appears in **Figure 28** plotted on an  $xy$ -grid for reference. Eliminating  $q$  between the  $x$ - and  $y$ -elements of the first row of the determinant, we arrive at  $x^2 - xy + y = 0$ , demonstrating that the  $q$ -scale is in fact a hyperbola. However, the layout of the  $q$ -scale is problematic, as the two halves stretch toward infinity very quickly and it is not possible to accurately locate  $q$ -points for isopleths near the asymptotes of the hyperbola. So we will transform this nomogram into one in which the  $q$ -scale is finite.

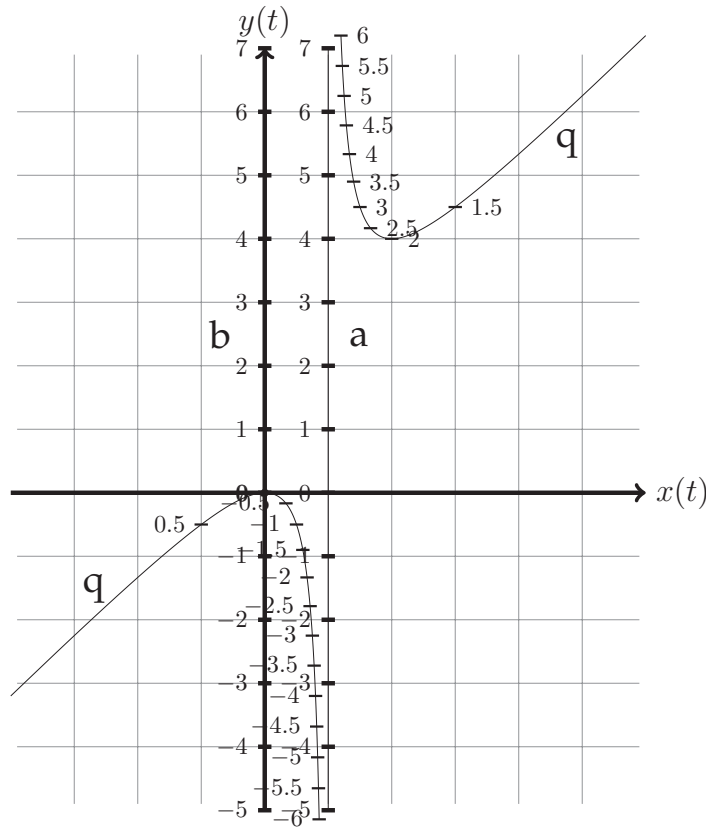

**Figure 28.** Original nomogram for  $q^2 - aq + b = 0$ .

First, we rotate the nomogram clockwise by  $\theta = 45^\circ$  and stretch it in both dimensions by  $\sqrt{2}$ , for a reason that will become apparent in the next transformation. The rotation plus stretch transforms the original nomogram **(a)** to **(b)** in **Figure 29**.

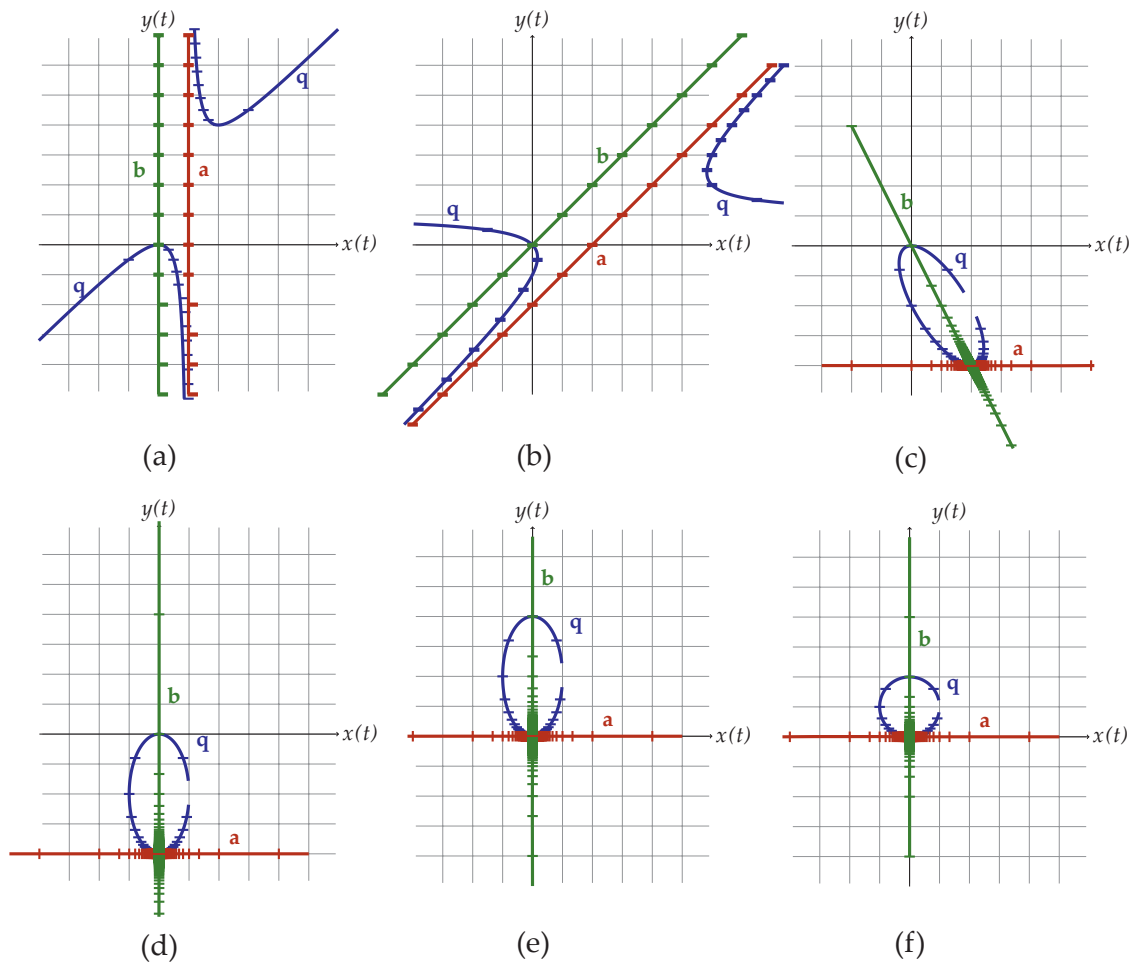

**Figure 29.** Transformation sequence for a nomogram of  $q^2 - aq + b = 0$ .

$$x_n \rightarrow x_n + y_n, \quad y_n \rightarrow -x_n + y_n;$$

$$\begin{vmatrix} \frac{q^2 + q}{q - 1} & q & 1 \\ a + 1 & a - 1 & 1 \\ b & b & 1 \end{vmatrix} = 0.$$

We rotated the nomogram because we want a vertical line (say,  $x = 1$ ) that does not intersect the hyperbola. A projection transformation can convert a scale with two branches (like this hyperbola) into a single connected scale (an ellipse) if a straight line separating the two branches is projected to infinity, that is, if the line is parallel to the  $yz$ -plane (which  $x = 1$  is) and the projection point  $P$  is located directly above or below it in its  $z$ -value (see **Figure 25b**). Choosing  $P = (1, -1, 1)$ , we find that an ellipse magically appears in (c).



$$x_n \rightarrow \frac{x_n}{x_n - 1}, \quad y_n \rightarrow \frac{-x_n - y_n}{x_n - 1};$$

$$\begin{vmatrix} \frac{q^2 + q}{q^2 + 1} & \frac{-2q^2}{q^2 + 1} & 1 \\ \frac{a + 1}{a} & -2 & 1 \\ \frac{b}{b - 1} & \frac{-2b}{b - 1} & 1 \end{vmatrix} = 0.$$

Now let's shear the nomogram so that the  $b$ -scale lies on the  $y$ -axis while keeping the  $a$ -scale parallel to the  $x$ -axis. We are shearing to the  $y$ -axis rather than to the  $x$ -axis as described earlier for shear; and for a  $b$ -scale slope of  $-0.5$ , we arrive at **(d)**.

$$x_n \rightarrow x_n + y_n/2, \quad y_n \rightarrow y_n;$$

$$\begin{vmatrix} \frac{q}{q^2 + 1} & \frac{-2q^2}{q^2 + 1} & 1 \\ \frac{1}{a} & -2 & 1 \\ 0 & \frac{-2b}{b - 1} & 1 \end{vmatrix} = 0.$$

Now we'll translate the nomogram upward by 2 to place the intersection point on the origin as in **(e)** and shrink the nomogram in the  $y$ -direction by a factor of 2 to get a circular  $q$ -scale as in **(f)**.

$$x_n \rightarrow x_n, \quad y_n \rightarrow (y_n + 2)/2;$$

$$\begin{vmatrix} \frac{q}{q^2 + 1} & \frac{1}{q^2 + 1} & 1 \\ \frac{1}{a} & 0 & 1 \\ 0 & \frac{-1}{b - 1} & 1 \end{vmatrix} = 0.$$

**Figure 30** is the plot of the final determinant, a very distinctive circular nomogram. The entire range of  $q$  from  $-\infty$  to  $+\infty$  is now represented in a finite area; and certainly the range less than 1.5, which veered to infinity in our original nomogram, is nicely accessible. The larger numbers are not as accessible, but the ranges can be skewed to spread out to any range by

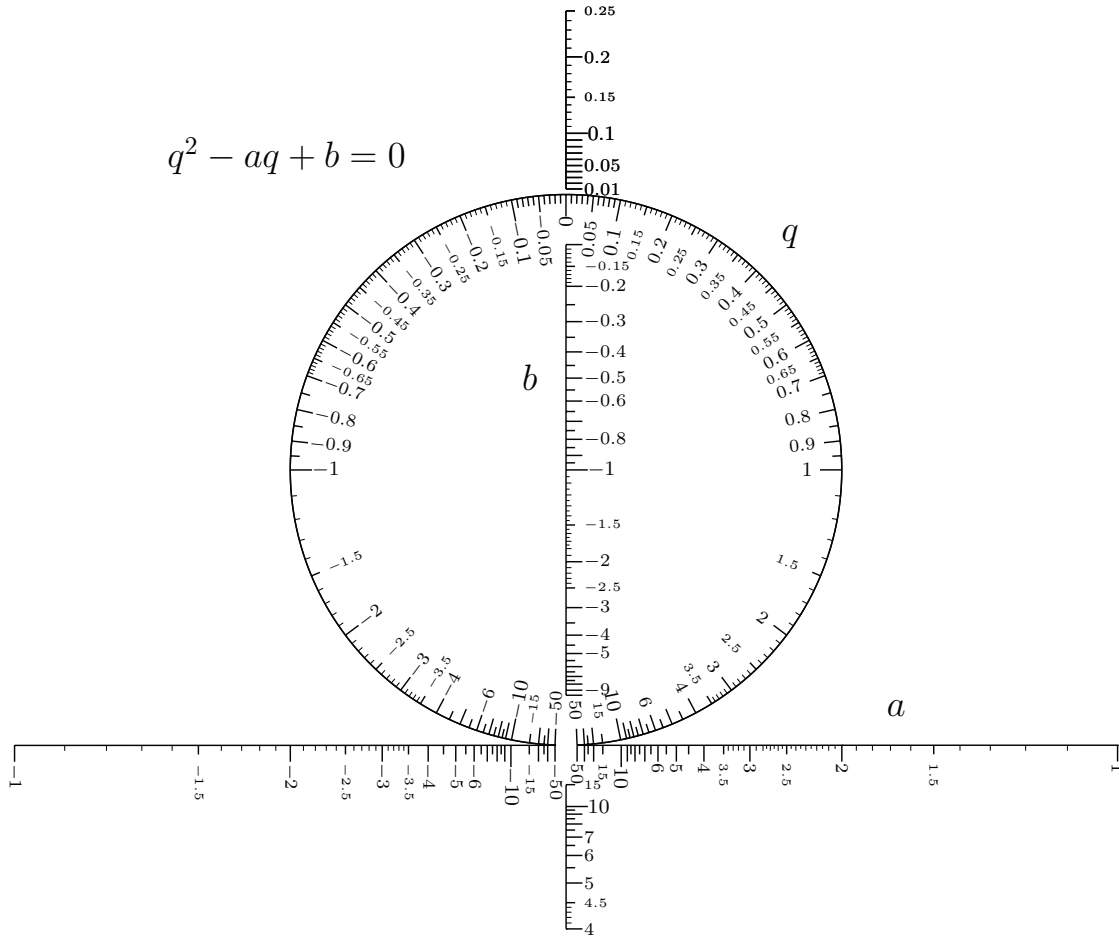

Figure 30. A circular nomogram for  $q^2 - aq + b = 0$  (after Epstein [1958]).

multiplying the original equation by a constant. We could have stopped at any of the nomograms containing an ellipse, but it is easier to draft the circle.

It's interesting to play around with a straightedge on the circular nomogram that we derived above to see that it works. In particular, an isopleth through a value of  $a$  and a value of  $b$  will just touch the  $q$ -circle if the discriminant  $a^2 - 4b$  from the quadratic formula is 0, providing the repeated real root. When the discriminant is less than zero, the isopleth misses the  $q$ -circle, denoting no real roots; and when the discriminant is greater than zero, the isopleth crosses the two real roots on the  $q$ -circle.

In fact, if you eliminate the  $a$ -scale, then the  $b$ -scale represents the product of two numbers on the  $q$ -circle, because if we have two solutions  $q_1$  and  $q_2$  for the equation  $q^2 - aq + b = 0$ , then the equation can be written as  $(q - q_1)(q - q_2) = 0$ . Multiplying this out and equating terms to the original equation, we find that  $b = q_1q_2$  and  $a = q_1 + q_2$ . It turns out that any three-line parallel-scale nomogram can be transformed into a nomogram with two scales on a circle and one on a line, although the scales on the

circle generally do not have the same values and require tickmarks on each side of the circumference.

Transformations can also be performed by multiplying a transformation matrix times the matrix of the nomogram determinant and taking the determinant of the result. Two or more transformations can be combined by multiplying their transformation matrices. (It often happens that after such a matrix multiplication, the nomogram determinant needs to be manipulated again into the standard nomographic form.) For example, the transformation matrices for rotation and projection are

$$\begin{pmatrix} \cos \theta & -\sin \theta & 0 \\ \sin \theta & \cos \theta & 0 \\ 0 & 0 & 1 \end{pmatrix} \quad \text{and} \quad \begin{pmatrix} -x_P & 0 & 0 \\ y_P & z_P & 0 \\ 0 & 0 & -x_P \end{pmatrix}.$$

It is possible to use matrix multiplication to map a trapezoidal shape (such as the boundaries of a nomogram that does not occupy a full rectangle) into a rectangular shape. This would increase the accuracy of the scales that can be expanded to fill the sheet of paper. Consider the following matrix multiplication:

$$\begin{pmatrix} k_{11} & k_{12} & k_{13} \\ k_{21} & k_{22} & k_{23} \\ k_{31} & k_{32} & k_{33} \end{pmatrix} \times \begin{pmatrix} x_u & y_u & 1 \\ x_v & y_v & 1 \\ x_w & y_w & 1 \end{pmatrix}.$$

By the rules of matrix multiplication and some manipulation of the result, each  $y'$  and  $x'$  in the resulting matrix can be represented as

$$x' = \frac{xk_{11} + yk_{21} + k_{31}}{xk_{13} + yk_{23} + k_{33}}, \quad y' = \frac{xk_{12} + yk_{22} + k_{32}}{xk_{13} + yk_{23} + k_{33}}.$$

Now, if we want to remap an area such that the points  $(x_1, y_1)$ ,  $(x_2, y_2)$ ,  $(x_3, y_3)$  and  $(x_4, y_4)$  map to, say, the rectangle  $(0, 0)$ ,  $(0, a)$ ,  $(b, 0)$  and  $(b, a)$ , we insert the final and initial  $x$ - and  $y$ -values into the formulas above, giving us eight equations in nine unknown  $k$ -values. So we choose one  $k$ , solve for the other eight  $k$ -values, multiply the original determinant by the  $k$ -matrix and convert it back to standard nomographic form, and replot the nomogram. It's not a lot of fun, really, but it demonstrates the efforts that were once devoted to nomography.

## Conclusion

Nomograms are fascinating artifacts in the history of mathematics, the culmination of efforts over many years to invent graphical calculators for scientific and engineering use. Basic nomographic designs exist for most forms of equations, more designs than are presented here, and transformations can customize them for greatest ease of use.

Today, the use of nomograms is scattered at best. There are many simple nomograms that doctors can use to quickly assess probabilities and attributes such as the body-mass index (BMI), and some science and engineering articles include nomograms. There is also a smattering of engineering nomograms found as supplements in catalogs by manufacturers. But there could be more applications of these where convenience and speed are paramount. Popular calculations such as exercise time and type vs. calories could be distributed on paper and customized by users with penciled additions. Medical patients could take nomograms home to post on refrigerators to consult and record information on; and paper organizers might include tax, tip, and mileage calculators. Mortgage and compound-interest calculations are a snap for anyone with a corresponding nomogram.

With a modern slant, nomograms could easily be incorporated into the colorful infographics that are so popular today. Nomograms that took days to analyze and draft on paper in the past can be generated in seconds on a computer and transformed interactively to produce radically different and innovative designs.

But nomograms have an intrinsic charm beyond their practical use. The more-beautiful ones attract interest with their mix of technical and artistic flair, much as unusual sundials draw people—in fact, the sun's shadow across curves on some sundial faces can be considered an isopleth. As a calculating aid, nomograms can solve very complicated formulas with amazing ease. As a curiosity, nomograms provide a satisfying, hands-on application of interesting mathematics in an engaging, creative activity.

## References

- Adams, Douglas P. 1964. *Nomography: Theory and Application*. Hamden, CT: Archon.
- Douglass, Raymond D., and Douglas P. Adams. 1947. *Elements of Nomography*. New York: McGraw-Hill.
- Epstein, L. Ivan. 1958. *Nomography*. New York: Interscience Publishers.
- Hoelscher, Randolph P., Joseph N. Arnold, and Stanley H. Pierce. 1958. *Graphic Aids in Engineering Computation*. New York: McGraw-Hill.
- Johnson, Lee H. 1952. *Nomography and Empirical Equations*. New York: John Wiley and Sons.
- d'Ocagne, Maurice. 1899. *Traité de nomographie*. Paris: Gauthier-Villars.
- Otto, Edward. 1963. *Nomography*. New York: Macmillan.
- Roschier, Leif, and Tapani Makkonen. *Star Navigation*. [http://www.pynomo.org/wiki/index.php/example:Star\\_navigation](http://www.pynomo.org/wiki/index.php/example:Star_navigation). Accessed 10 September 2009.

Soreau, Rodolphe. 1902. *Contribution á la théorie et aux applications de la nomographie*. Paris: Ch. Bèranger.

## About the Author



Ron Doerfler is a systems engineer in the Defensive Systems Division of the Northrop Grumman Corporation in Rolling Meadows, IL. He is the author of a book on mental calculation, *Dead Reckoning: Calculating Without Instruments* (1993). He writes essays on the history of science for his blog, “Dead Reckonings: Lost Art in the Mathematical Sciences,” at <http://www.myreckonings.com/wordpress>.

