

OLEG D. JEFIMENKO
West Virginia University

Electrostatic Motors

Their History, Types, and
Principles of Operation —

With many illustrations, of which 57 are
by
David K. Walker
of
Waynesburg College

Electret Scientific Company
Star City

UNIVERSITY OF COLORADO
DENVER CAMPUS LIBRARY

This book is dedicated to an accomplished
farmer, craftsman, musician,
educator, and lawyer
MY FATHER

Copyright © 1973 by
Electret Scientific Company
P.O. Box No. 4132
Star City, West Virginia 26505

All rights reserved

Printed in the United States of America

PREFACE

The fascinating science of electrostatics was developed mainly in the 18th century at a time when the technology and industry were too primitive to put this science to practical uses. As a result, serious research in electrostatics soon lost its momentum and, except for a few isolated efforts, was practically nonexistent during the entire 19th century. Only very recently practical aspects of electrostatics began to make their impact on the industry and economy, and the once glamorous but long forgotten science has again appeared at the focal point of serious scientific investigations.

A peculiar obstacle stands, however, in the way of many such investigations: because of the one and one half century of neglect of electrostatic explorations there is a singular lack of easily available quantitative and qualitative information on even the most basic electrostatic phenomena, techniques, and devices. Whereas experimental and theoretical data pertaining to most modern sciences are well documented and are easily retrievable from numerous reference sources, many data in the field of electrostatics

must be extracted through thorough and laborious firsthand studies of old books and magazines, the very existence of which is not generally known, and which are not readily available in any of the present-day libraries or repositories.

It is precisely this kind of obstacle that the author encountered, when several years ago he started his research on electrostatic motors. Luckily, however, the obstacle soon transformed itself into a highly rewarding experience of studying various "ancient" books and periodicals and searching through electrostatic inventories of various European and American science museums. In the course of these studies he found numerous forgotten publications on electrostatic motors and found that several old electrostatic motors can actually be seen in some of the museums. (It is interesting to note that the latter motors are usually not on public display, apparently because of a lack of adequate information about their purpose and mode of operation available to museum personnel. It is also interesting to note that certain types of electrostatic motors were frequently employed in various animated toys during the second half of the 18th century, and that, although some of these toys are shown in museums, they are usually shown without an explanation of what made them move or how they were supposed to function.)

The purpose of this book is to describe the various types of electrostatic motors reported in

the scientific literature between 1700 and the present, and to discuss in general terms their various design features and principles of operation. The book is written for a wide circle of readers, and care has been taken to avoid technical details that would be useful only to a small group of specialists. The readers interested in additional scientific and technical data on the various motors are referred to appropriate original publications cited in this book.

The material is presented in several chapters, each chapter describing a particular class of motors. The sequence of the chapters corresponds to the chronological order in which the earliest motor belonging to each particular chapter was invented. The sequence of material in each chapter is normally arranged also in a chronological order. The last chapter describes some of the most recent research results on electrostatic motors and extrapolates these results into the immediate future.

The author is grateful to his wife Valentina for typing the manuscript and for otherwise helping him to make the book ready for publication. He is also grateful to Dr. David K. Walker for reading the manuscript and for drawing the illustrations for the book.

Oleg D. Jefimenko

CONTENTS

Preface	vii
1. What are Electrostatic Motors?	1
<i>Electromagnetic and Electrostatic Motors. Some Unique Properties of Electrostatic Motors. Classification of Electrostatic Motors.</i>	
2. Electric Pendulum Motors; Contact Motors.	6
<i>Gordon Electric Bells. Electric Swing. Electric Seesaw. Electric Perpetuum Mobile. Dailey Reciprocating Motor. Electric Racing Ball.</i>	
3. Electric Wind Motors.	22
<i>Gordon Electric Fly. Hamilton Electrometer. Langenbucher Electrometer. Electric Orrery. Kinnersley Electric Horse-Race. Bichat Electric Tourniquet. Corona-Kraft Levitation. Electric Wind Wheels and Turbines. King Electric Rabbit Hunt.</i>	

4. Franklin's Spark Motors and Their Descendants. 39
Franklin First Motor. Franklin Second Motor. Moore Motors. Bell Jar Motors. Another Electric Perpetuum Mobile. Dressel Nuclear Battery Motor.
5. Corona Motors and Motors Similar to Them. 56
Holtz Rotation Phenomenon. Poggen-dorff Motor. Christiansen Motors. Gruel Electric Tourbillion. Ruhmkorff Motor. Johnson Motors. McVay Motors.
6. Capacitor Motors. 73
Zipernowsky Motor. Van Huffel Motor. Synchronous and Asynchronous Motors. Bollée Capacitor Motors. Moore Interdigital Motor.
7. Induction Motors. 84
Arno Motor. Weiler Induction Motors. Bollée Induction Motors. Choi and Dunn Motor.
8. Liquid-Immersed Motors. 91
Weiler Liquid-Immersed Motor. Secker Motors. Quincke Motor.

9. Electret Motors. 97
Gubkin Motor. Slot-Effect Motors. Synchronous Electret Motor.
10. What to Expect from Electrostatic Motors. 106
Motors for Miniaturized Systems. New Corona Motors. Sources of Power for Electrostatic Motors. Operation of Electrostatic Motors from Atmospheric Electricity.
11. Index 120

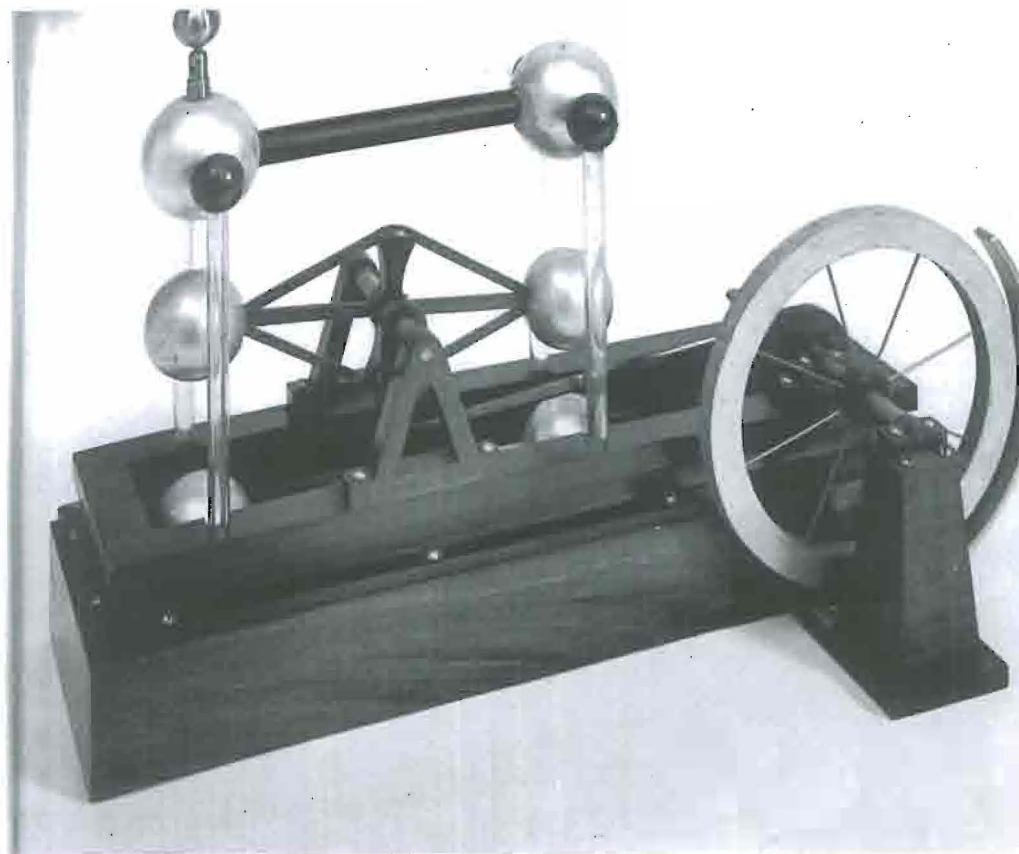

PLATE 1

Here is what H. B. Dailey wrote about this electrostatic motor which he and his father built in 1880: "Whether or not there is about the instrument and its history that which would ever give it a claim to any measure or serious interest, it is at least an electric motor most unique. A motor without magnetism, wiring, or any iron in its make up. A motor that runs by the action of the direct push and pull of the pure unconverted electricity itself".

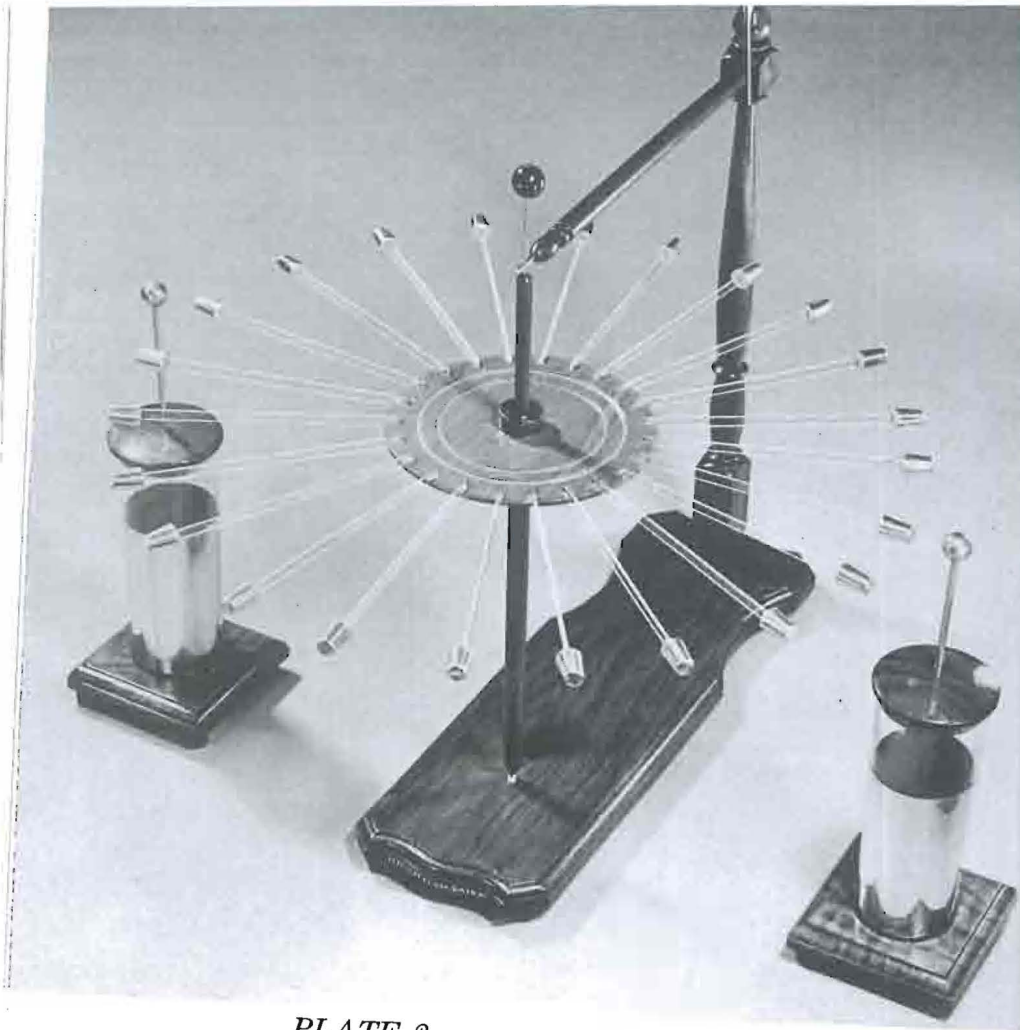

PLATE 2

It was Benjamin Franklin who in 1748 constructed the first electrostatic motors. No original drawings or models of his motors are known to exist, but his first motor must have looked very similar to this replica designed by the author for the Electret Scientific Company.

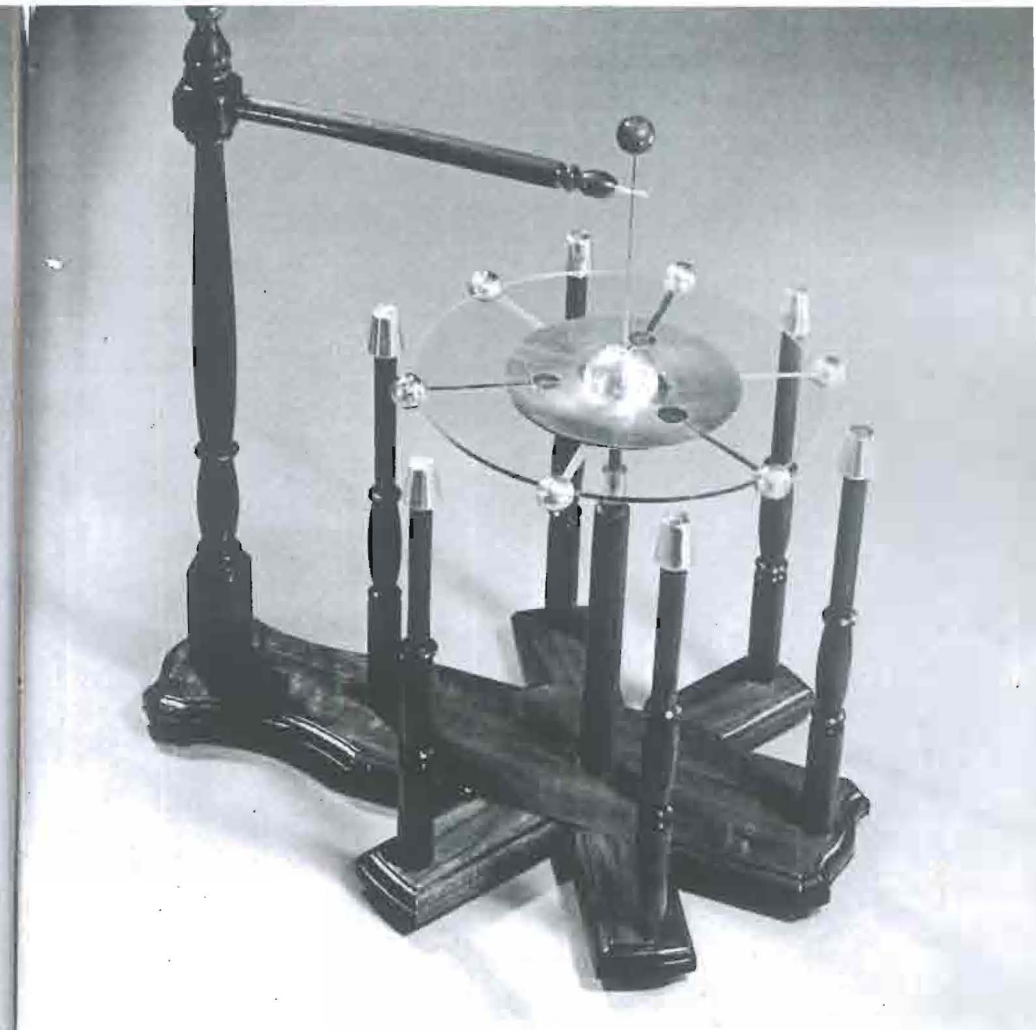

PLATE 3

Franklin's second motor probably looked very much like this replica also designed by the author for the Electret Scientific Company. Whereas the first motor operated from the electricity stored in Leyden jars, this motor operated from the electricity stored in the motor itself.

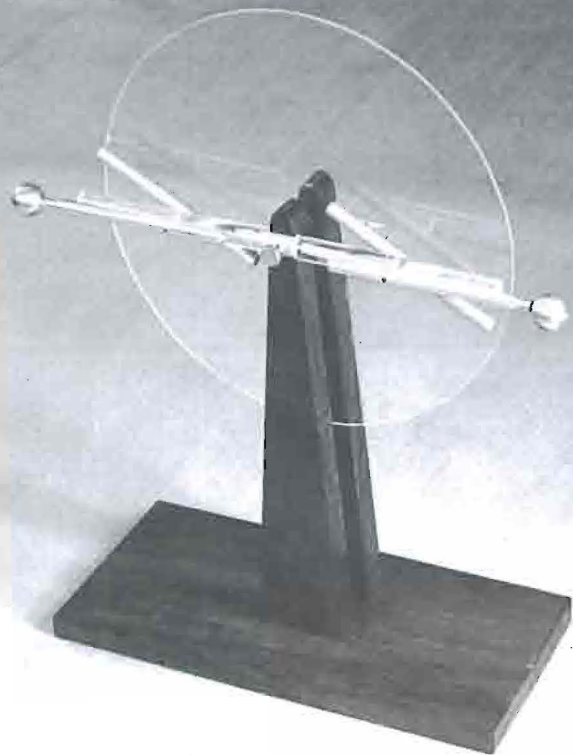

PLATE 4

The first corona motor was designed around 1869 by the German physicist Poggendorff. Poggendorff made a thorough study of the motor, but failed to appreciate its possibilities in the mistaken belief that no sources of electricity could supply enough power to any electric motor to make it do useful work. This simplified version of Poggendorff's motor was built by the author.

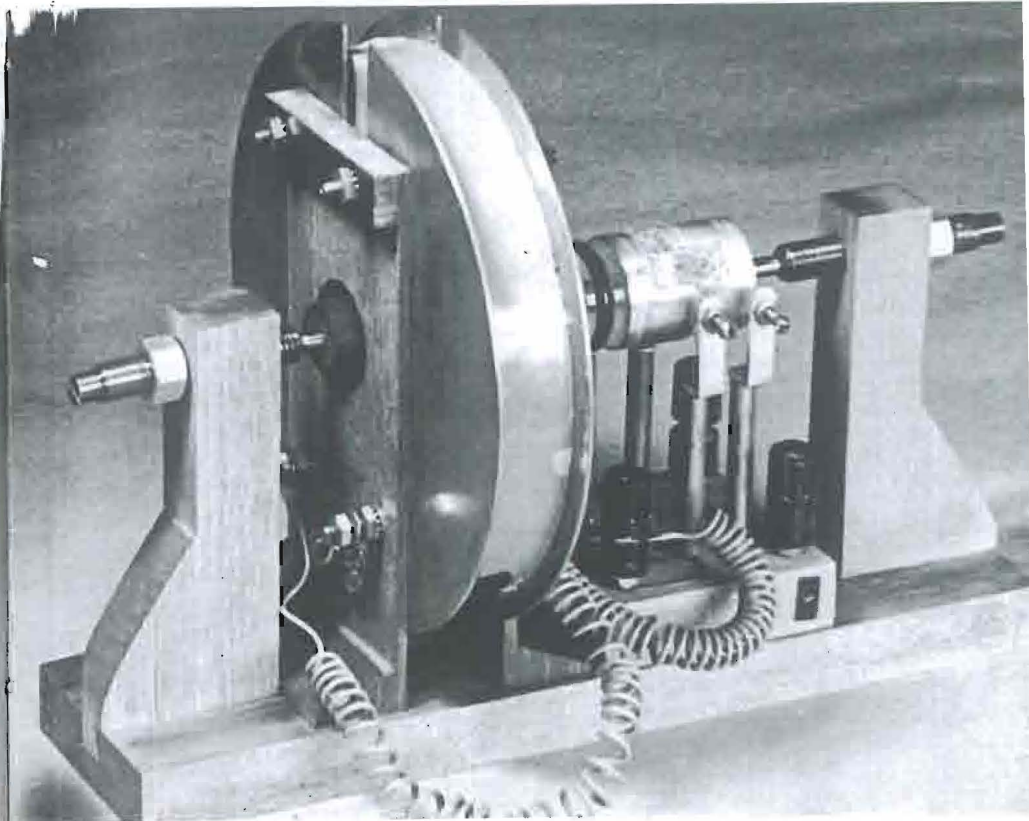

PLATE 5

The electret—a permanently electrized dielectric—is essentially a product of the 20th century. When an electret is placed between slotted electrodes to which a voltage is applied, the electret experiences a force. This motor designed by the author utilizes the slot effect. The rotor of the motor is a carnauba wax electret made of two oppositely polarized half-disks. The motor was built in 1966.

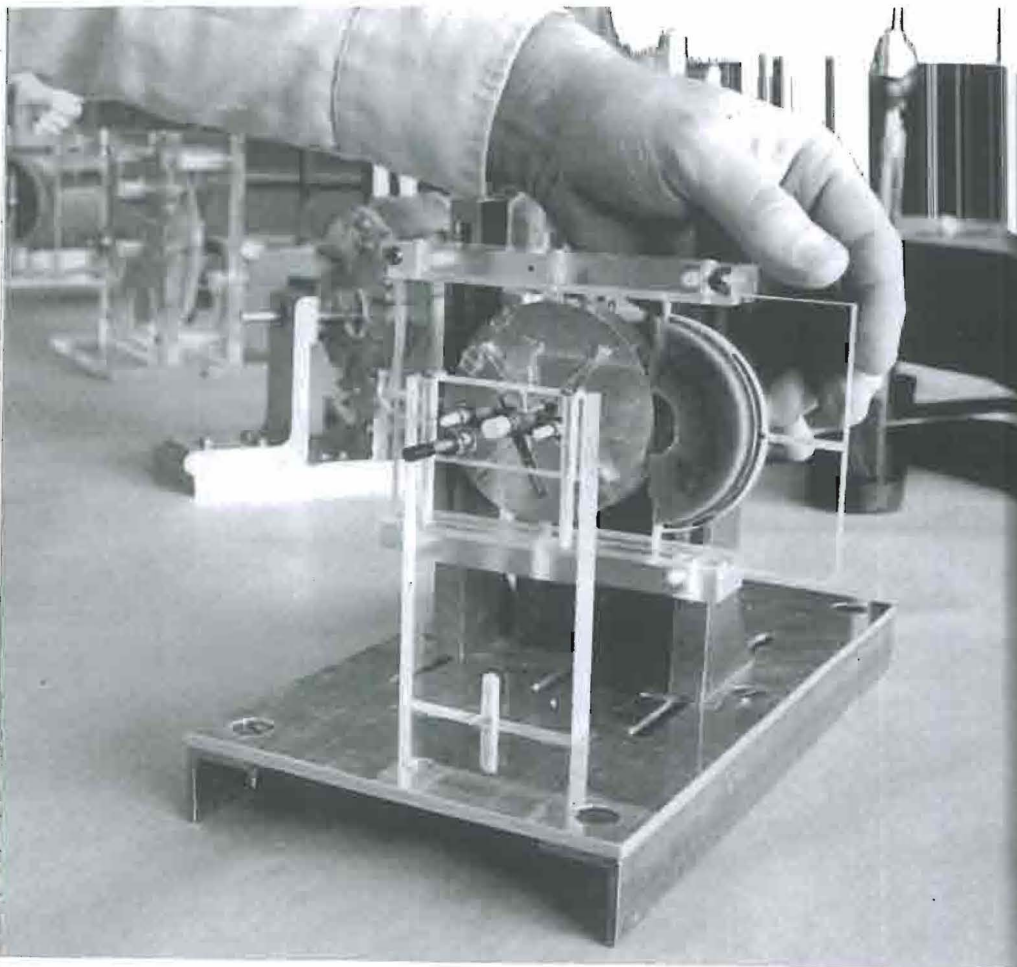

PLATE 6

A more practical design of an electret motor incorporates stationary electrets and rotating electrodes. The electrets can be easily withdrawn from the motor for servicing or replacement. The motor operates from approximately 60 volts dc. This particular motor was the first ever operated from atmospheric electricity.

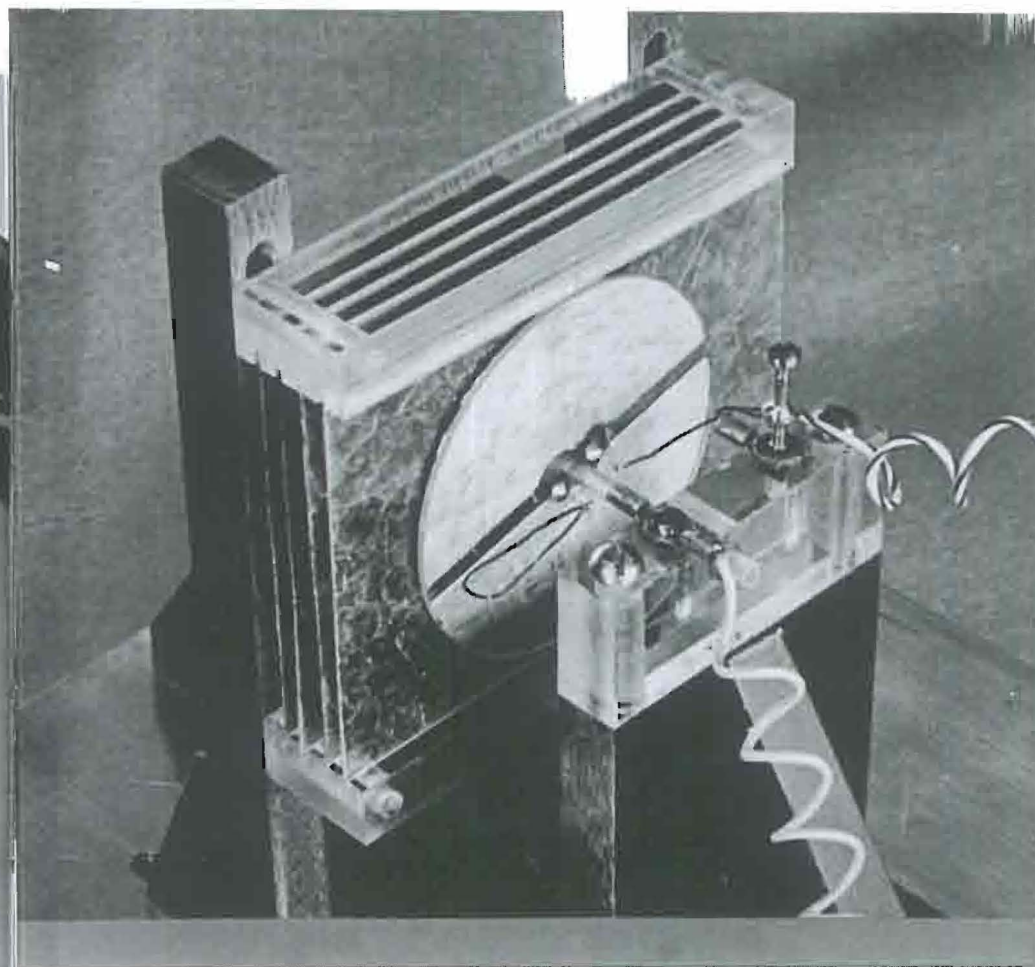

PLATE 7

In this electret motor developed in the author's laboratory (as were all the electret motors reproduced in these photographs) several thin mica electrets are used as active elements. This arrangement of electrets makes good use of the available space and allows one to construct relatively powerful electret motors.

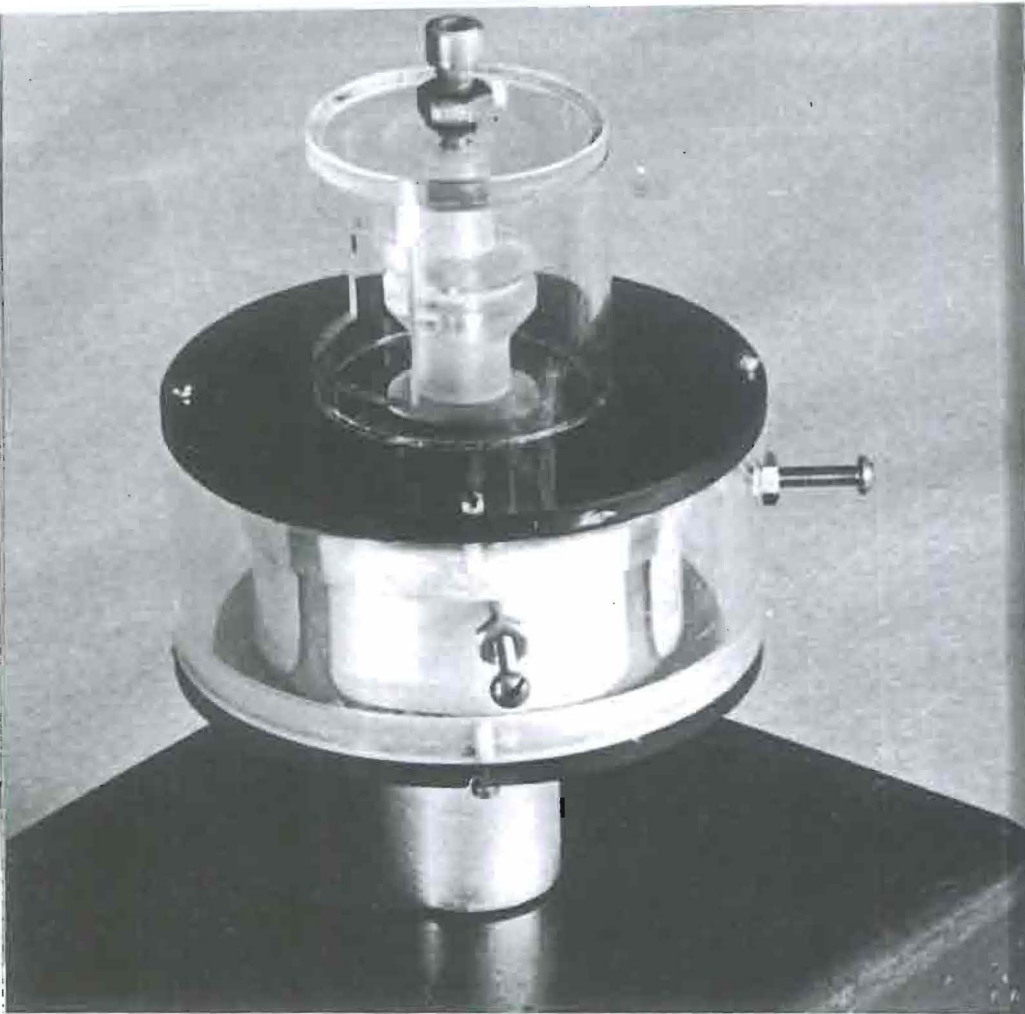

PLATE 8

This "hoop" electret motor built in 1967 by D. K. Walker has a stationary cylindrical electret. The rotor is made of four pairs of bent aluminum plates enclosing the electret. The motor requires no commutator. The motor has been operated for several years without any servicing.

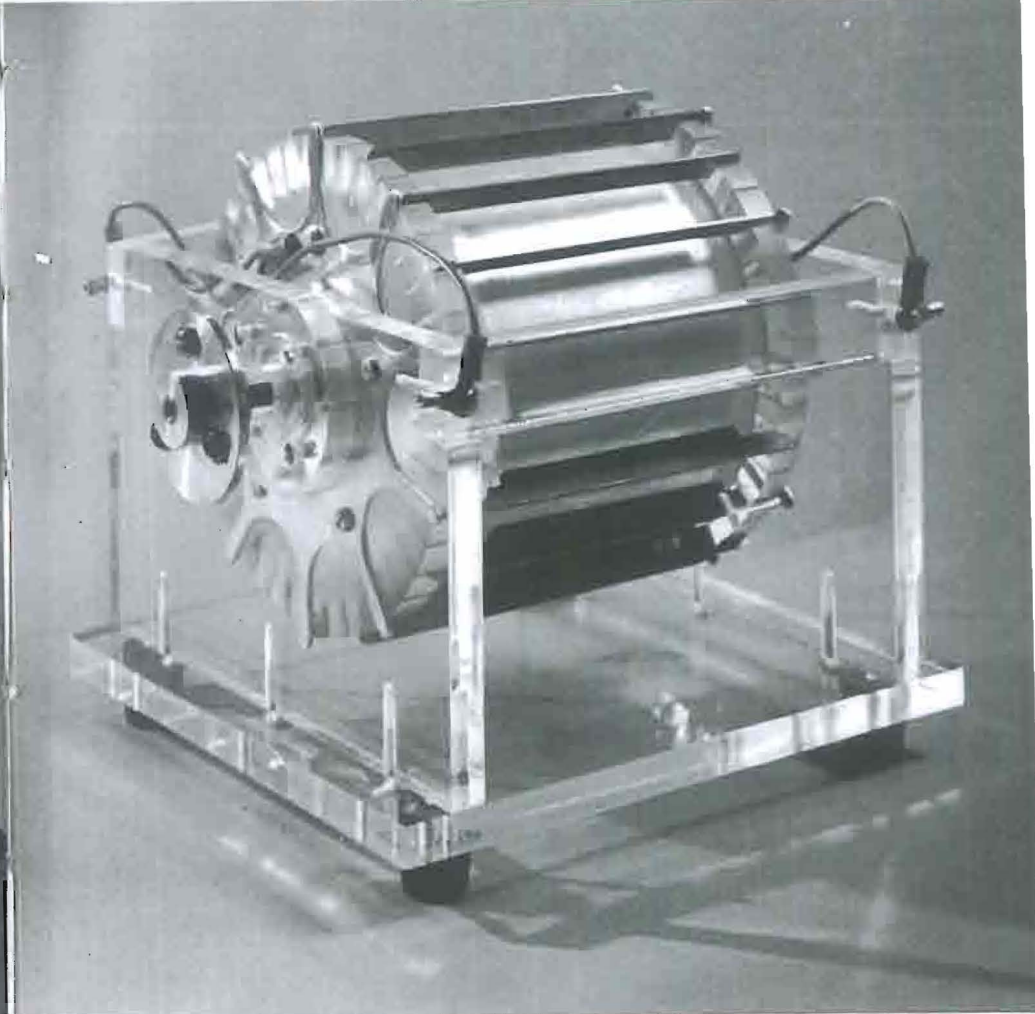

PLATE 9

Corona motors are probably the most promising electrostatic motors. This 0.1-hp modern version of the Poggendorff motor has a cylindrical rotor instead of a disk. The motor operates from a 6000-volt power supply as well as from an earth field antenna.

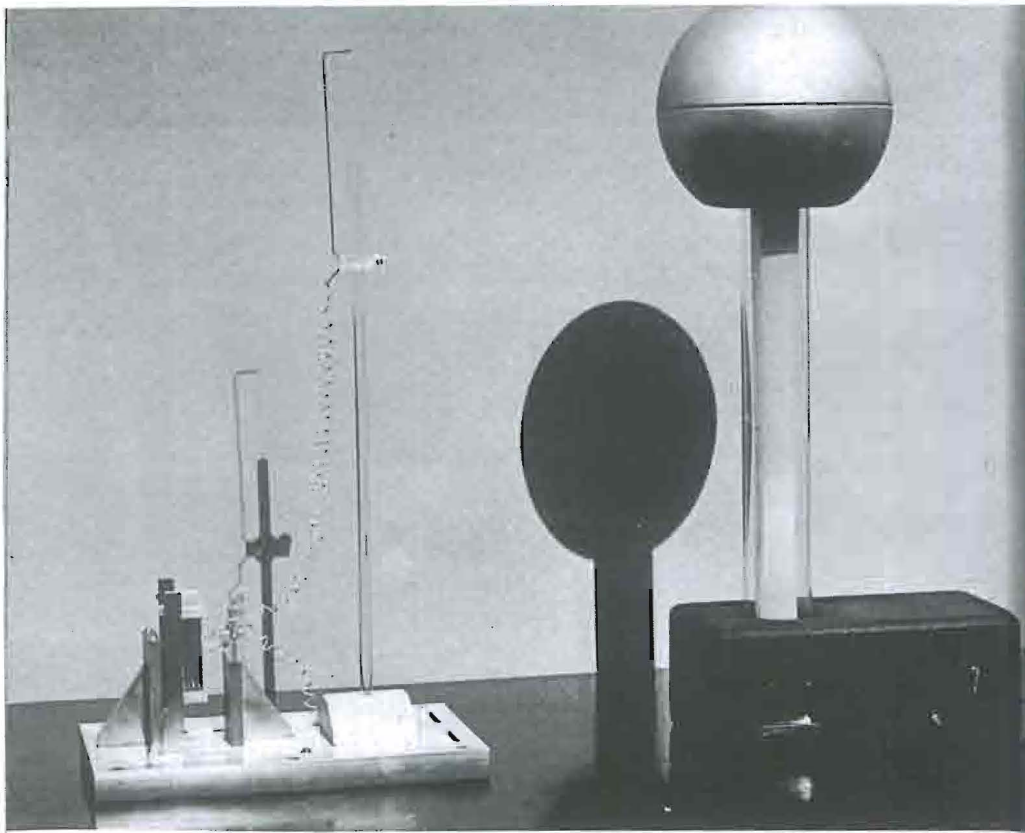

PLATE 10

The operation of electrostatic motors from antennas can be demonstrated with this lecture-room apparatus. The Van de Graaff generator produces electric charges in the air. The sharp-point antenna collects the charges from the air and delivers them to one terminal of an electrostatic motor whose other terminal is grounded.



PLATE 11

The author and D. K. Walker attempt to operate an electret motor from a 20-foot pole antenna in front of the Physics Building of the West Virginia University. The tall building screened the atmospheric field, and the motor did not run, although it operated very well from the same antenna in the nearby unobstructed parking lot.

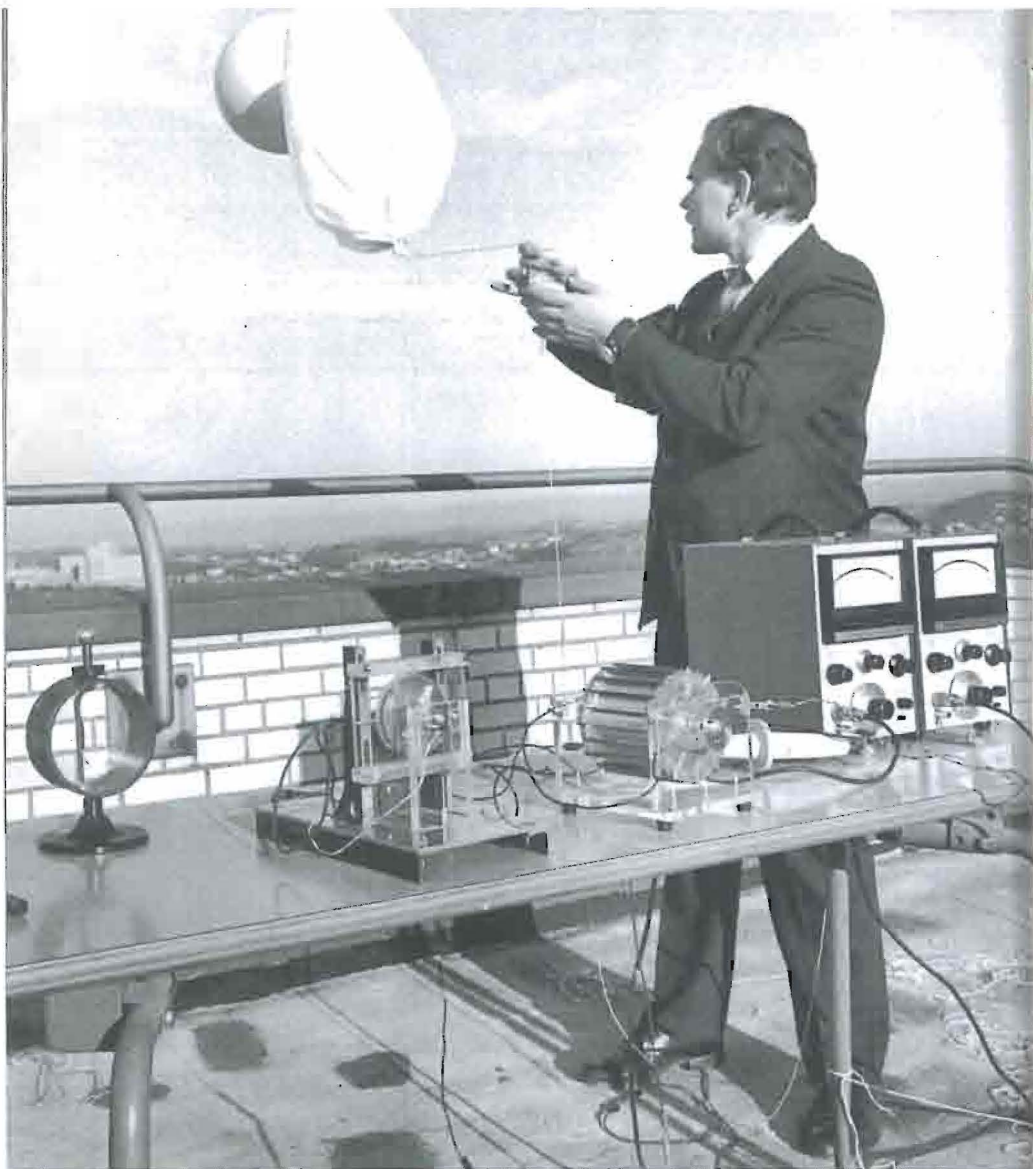

PLATE 12

The author operates electrostatic motors by means of an airborne antenna.

1

WHAT ARE ELECTROSTATIC MOTORS?

Conventional electric motors create mechanical motion as a result of magnetic forces acting upon electric currents. These motors are properly called *electromagnetic motors*. There is, however, another type of electric motor, in which the motion is created as a result of electric, or "electrostatic", forces acting between electric charges. Motors of this type are called *electrostatic motors*.

It is interesting to note that in nature the electrostatic forces are much stronger than the magnetic ones. There are many ways in which this can be demonstrated. For example, although a considerable effort may be needed to separate a magnet from an object attracted by it, a much greater effort is needed to break the magnet; this is because the magnet and the object are held together by magnetic forces, while the mol-

ecules of matter in the magnet (as well as in any other body) are held together by electrostatic forces.

Why, then, do we not use the electrostatic forces in our electric devices, and in motors in particular, at least on as wide a scale as we use the "inferior" magnetic forces? There are two main reasons for that. First, it is difficult to establish appreciable concentrations of electric charges without causing an electric breakdown in the medium surrounding or supporting the charges (although with modern insulating materials and techniques this difficulty becomes progressively less serious). Second, powerful electrostatic devices require voltages of many kilovolts for their operation, and until recently such voltages could not be produced conveniently and economically.

Motors of great power, however, are not the only ones needed. Equally important are low-power motors capable of performing various special tasks. In this respect electrostatic motors may compete successfully with their electromagnetic cousins even now.

Although electrostatic motors are not yet widely known or used, they already hold at least five very impressive records as compared with the electromagnetic motors:

1. The first electric motor ever invented was an electrostatic one. It was built about 100 years before the first electromagnetic motor was conceived.

2. The electric motor that operated without interruption longer than any other electric motor was an electrostatic one. This was a pendulum-type motor, known as the "electric perpetuum mobile", installed at the University of Insbruck, Austria, in 1823. Since then it operated continuously at least until 1909, powered by a Zamboni pile (an early high-voltage battery).

3. Electrostatic motors have been operated from voltages in excess of 10^5 volts, which is much higher than the voltages suitable for operating electromagnetic motors.

4. Electrostatic motors have been operated by using currents smaller than 10^{-9} amp, which is much less than the currents needed to operate electromagnetic motors.

5. The first electric motor that operated directly from the atmospheric electricity was an electrostatic motor. None of the presently available electromagnetic motors can operate directly from this source.

Even this short list reflecting some of the more obvious peculiarities of electrostatic motors shows quite clearly that electrostatic motors possess a number of unique properties. These properties undoubtedly will make electrostatic motors increasingly more important for the science, engineering, and technology of the future.

Many different types and designs of electrostatic motors are possible. It is customary to classify electrostatic motors in accordance with

some prominent feature of their mode of operation or some prominent feature of their design. Thus, in reference to the techniques used for delivering electric charges to the active part of a motor one speaks of *contact motors*, *spark motors*, *corona motors*, *induction motors*, and *electret motors*. In reference to the medium in which the active part of a motor is located one speaks of *liquid- or gas-immersed motors*. In reference to the material and design of the active part of a motor one speaks of *dielectric motors* (the active part is made mainly of dielectric material) and *conducting-plate, or capacitor, motors* (the active part is made mainly of metal and resembles a variable capacitor). Finally, in reference to the rate of rotation of a motor relative to the period of the applied voltage (for ac operated motors) one speaks of *synchronous motors* and *asynchronous motors*.

This classification of electrostatic motors does not make it possible, however, to specify uniquely each individual motor. Also, two or more different operation modes are usually possible for most electrostatic motors (for example, certain motors can be operated at will as contact, spark, or corona motors). Therefore an assignment of a particular motor to one or another of the above types or categories is frequently more or less arbitrary. This applies, of course, also to the present book, where certain motors described in the chapters that follow could be equally well discussed under different chapter headings, and

where the inclusion of certain motors in a particular chapter was occasionally dictated by the fact that such an inclusion resulted in a more coherent development of the subject matter.

2

ELECTRIC PENDULUM MOTORS; CONTACT MOTORS

If "electric motor" is understood to be a device converting electric energy into a continuous mechanical motion, then the first two electric motors were invented in the early 1740's by Andrew Gordon, a Scottish Benedictine monk and professor of philosophy at Erfurt, Germany.¹ Gordon's first motor was a device known as the "electric bells" (his second motor will be described in the next chapter). The device and its operation were as follows. A metallic clapper (pendulum) was suspended by a silk thread between two oppositely charged bells (Fig. 1). From an initial contact with one of the bells the clapper acquired a charge of the same polarity as that of the bell. Due to repulsion of like charges and attraction of opposite charges the clapper was then repelled by this bell and attracted by the second bell. As the clapper

struck the second bell, it gave off its initial charge and acquired a charge of the same polarity as that of the second bell. Then the clapper was repelled by the latter and attracted by the first bell, which it struck again, and so on.

Numerous variations of Gordon's bells have been described by later authors, mostly as devices for lecture-room demonstrations of electrostatic forces. Such devices are widely used for this purpose even now.

An ingenious application of Gordon's bells was made by Benjamin Franklin in 1752. He connected the bells to an insulated lightning rod as a warning device "to give notice when the rod should be electrified".² (It appears that at that time neither Franklin nor any other scientist suspected how dangerous this "warning" device could be. The extreme danger of experiments with insulated lightning rods became clear a year later, when in 1753 the Russian physicist George Wilhelm Richmann was killed by lightning that entered his laboratory through such a rod, as he approached it in order to measure its electrification with a specially constructed electrometer.)

In a later modification of Gordon's invention one of the two bells was mounted on a Leyden jar (Fig. 2); the bells would then ring for as long as there was enough electric energy stored in the jar to move the clapper. (Franklin described the operation of an electric pendulum powered by a Leyden jar in 1747; see Ref. 2, p. 189.)

Sometimes Gordon's bells were made as a set

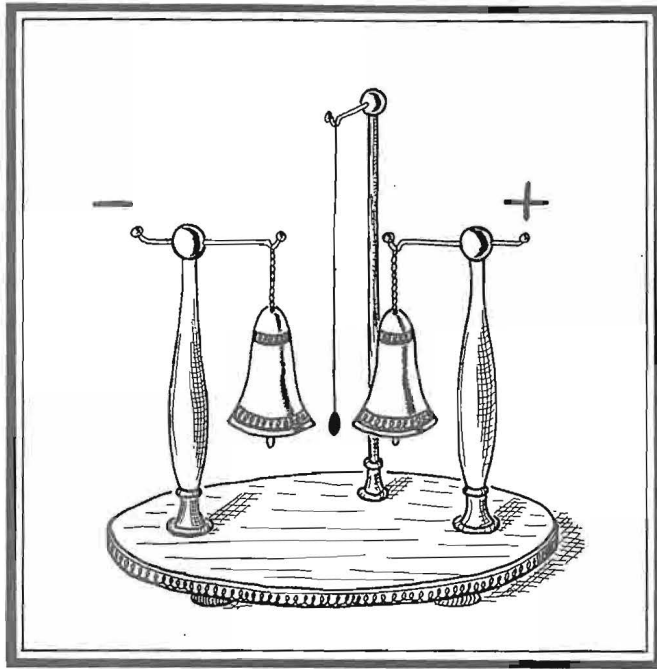

FIGURE 1

The so-called "electric bells" constituted the first device that converted electrical energy into a continuous mechanical motion. They were invented in about 1742 by Andrew Gordon, a professor of philosophy at Erfurt, Germany.

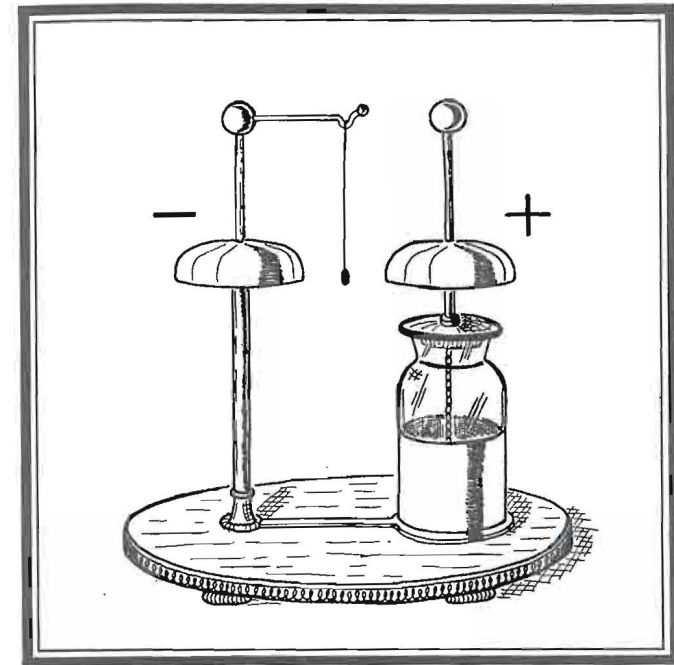

FIGURE 2

In a later modification of Gordon's invention one of the two bells was mounted on a Leyden jar. The bells would then ring for as long as there was enough electrical energy stored in the jar to move the clapper.

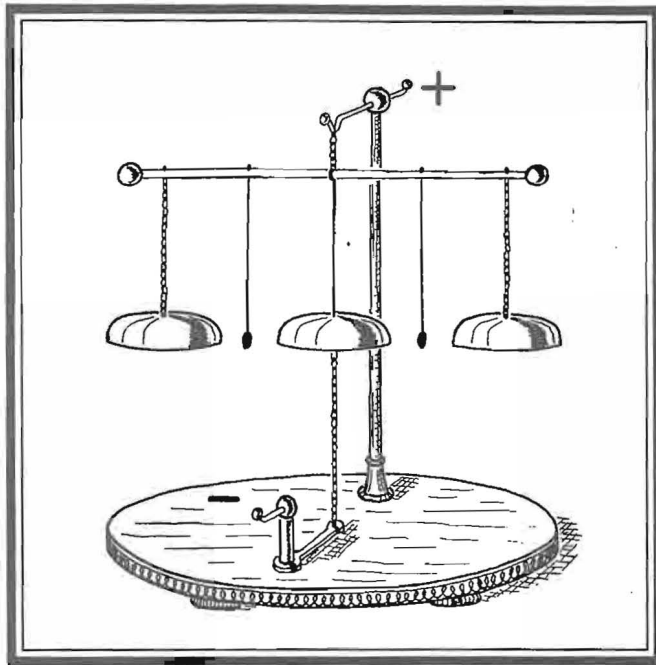

FIGURE 3

Sometimes Gordon's bells were made as a set of three bells and two clappers, all suspended from a horizontal bar, the central bell being insulated from the bar and grounded by means of a light chain.

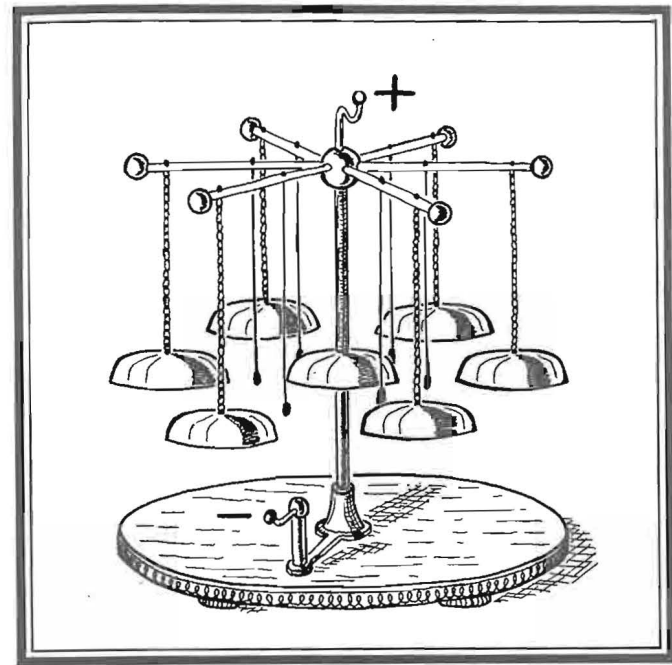

FIGURE 4

Another modification of Gordon's bells was a set of bell chimes arranged on a wooden base in a circular formation around the central bell. A separate clapper was then present for each of the outside bells.

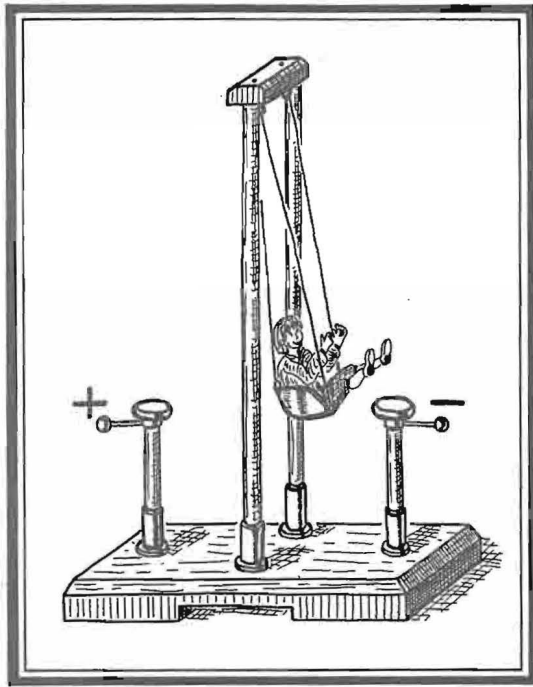

FIGURE 5

The electrical and mechanical principle of Gordon's invention could be used not only for ringing bells but for creating a mechanical motion in general. In this "electric swing" this principle was used to operate an animated toy.

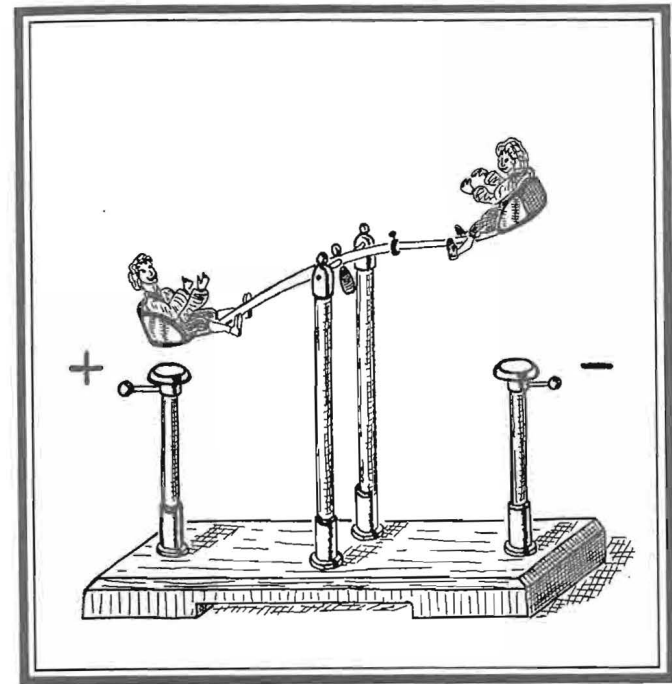

FIGURE 6

Various electrostatically operated toys were invented in the 18th and 19th centuries. This "electric seesaw" was basically a conducting bar oscillating about a horizontal axis on the same principle as the clapper of Gordon's bells.

of three bells and two clappers, all suspended from a horizontal bar, the central bell being insulated from the bar and grounded by means of a light chain (Fig. 3). Another modification of Gordon's bells was a set of bell chimes arranged in a circular formation around the central bell (Fig. 4); a separate clapper was then present for each of the outside bells, each clapper moving between one of the latter and the central bell (the central bell was usually grounded, the outside bells were connected to an electrostatic generator).

The electrical and mechanical principle of Gordon's invention could be used, of course, not only for ringing bells but also for a variety of other purposes. In particular, this principle was later used in two electrically operated toys: the "electric swing" and the "electric seesaw", which utilized, respectively, an insulated pendulum made as a swing (Fig. 5) and an insulated conducting swing bar capable of oscillating about a horizontal axis (Fig. 6).^{3,4}

Except for Franklin's bells, all of the above devices were designed for operation from an electrostatic generator or from Leyden jars charged by such a generator. However, in 1806 a high-voltage chemical battery ("dry pile", later known as the "Zamboni pile") was invented by Georg Behrens, and in 1810 this pile was adapted by Giuseppe Zamboni to operate primitive electrostatic motors.⁵ Inasmuch as a Zamboni pile could remain active for many years, the

little motors that operated from it were known as the "electric perpetuum mobile". An example of such a perpetuum mobile is shown in Fig. 7 (see Chapter 4 for another design). The apparatus consisted of a light rigid insulated pendulum, pivoted just above the center of gravity, with a light conducting ring at the top. The ring was located between the two knobs of a Zamboni pile. When the ring contacted one of the knobs, it acquired a charge from the knob and was repelled from this knob and attracted to the second knob, and so on, just like the clapper in Gordon's bells. One such perpetuum mobile is reported to have operated without interruption for at least 86 years.⁶

The most sophisticated device derivable from Gordon's electric bells was probably the reciprocating electrostatic motor (Fig. 8 and Plate 1) built in 1880 by Howard B. Dailey and Elijah M. Dailey.⁷ The motor, which is now at the Museum of History and Technology of the Smithsonian Institution, was described by one of its builders as follows:

"This machine operates by the direct action of static electric attractions and repulsions. It is constructed entirely of fine wood, glass and hard rubber, there being no magnetic materials used. The flywheel is of laminated, soft wood and runs in journal bearings of very small diameter. The moving balls, mounted on the walking beam of vulcanite, are made of wood, hollowed out so that the walls are about 2 millimeters thick.

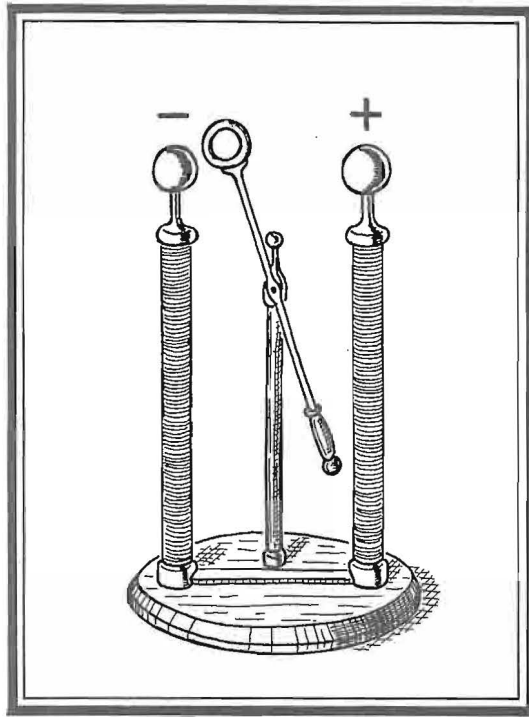

FIGURE 7

This electric pendulum operated from a Zamboni pile, an early high-voltage battery. Since the pile remained active for years, the pendulum was known as an "electric perpetuum mobile".

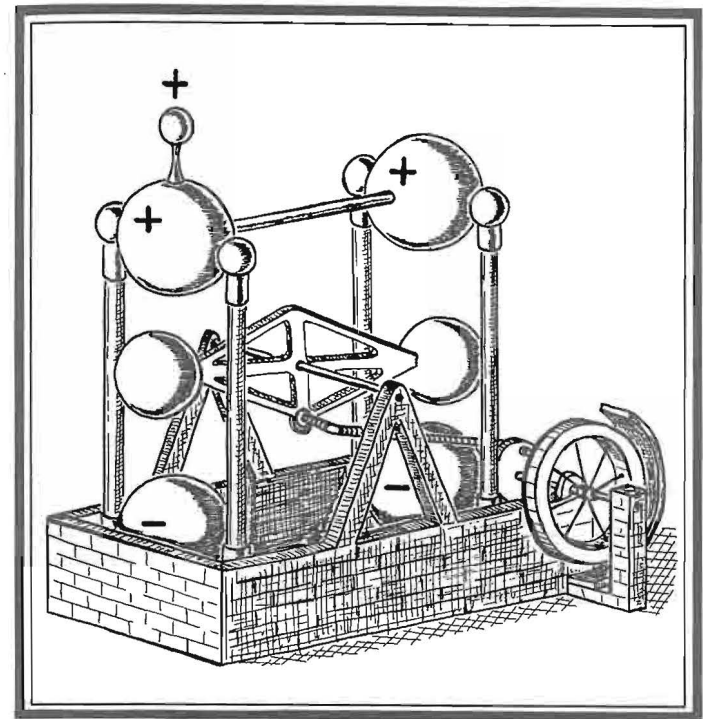

FIGURE 8

The most sophisticated device derivable from Gordon's bells was probably this reciprocating electrostatic motor built in 1880 by H. B. Dailey and E. M. Dailey.

They are covered with aluminum foil for static conductivity. The stationary balls are of solid wood.

"To operate the engine the stationary balls are charged with electricity from a static electric generator, such as a Holtz machine, the upper balls being connected through the brass ball to one pole of the machine while the lower stationary balls are connected through the binding post on the bed frame to the opposite pole of the machine. Under proper conditions, when charged, the engine will make about 375 revolutions per minute.

"The walnut base upon which the engine is mounted is 14" long, 4" wide and 1 $\frac{3}{4}$ " thick. The movable balls are about 1 $\frac{1}{2}$ " in diameter; the upper stationary balls are 1 $\frac{3}{4}$ " in diameter; and the lower stationary balls, 1 $\frac{1}{2}$ ". The four glass rods, mounted vertically, are about 6" high and spaced 6" apart along the bed. The diameter of the flywheel is 5 $\frac{3}{4}$ ". It is gilded and has small wire spokes. The connecting rod is 7" in length."*

The electric principle of Gordon's bells could be used also for producing a continuous unidirectional motion. A fascinating device of this type was the "electric racing ball", or the "electric planetarium", an excellent description of

*The author is grateful to Mr. Elliot N. Sivowitch, Smithsonian Institution Museum Specialist, for kindly providing this description and the photograph of Dailey's motor.

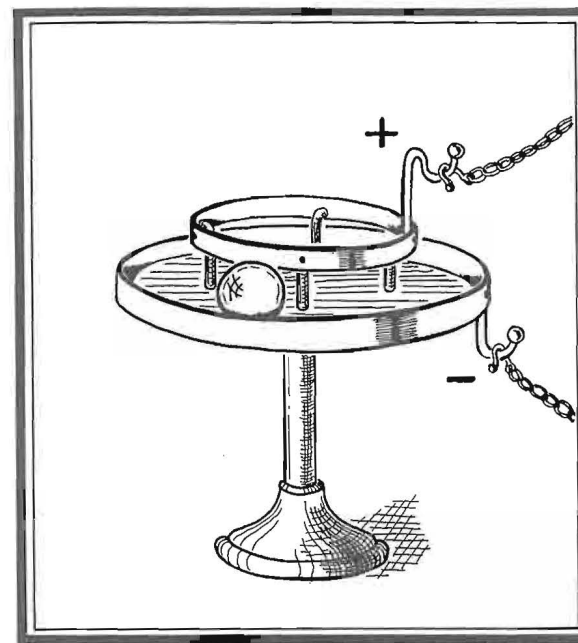

FIGURE 9

The electric principle of Gordon's bells could be used also for producing a continuous unidirectional motion. This "electric racing ball" was propelled along a conducting hoop by the same mechanism that moved the clapper in Gordon's bells.

which has been provided by M. Guyot.⁸ The apparatus consisted of an insulated horizontal conducting hoop positioned above a conducting disk having a vertical rim concentric with the hoop (Fig. 9). The arrangement constituted a track for a light sphere of glass placed on the disk between the hoop and the rim. When the hoop and the disk were connected to an electrostatic generator, the sphere ran along this track due to attraction and repulsion exerted by the hoop and the disk upon the points of the sphere that acquired charges from contact with the disk and the hoop (the rolling of the sphere usually had to be initiated with a light push by hand, but once the sphere had started to run, it continued running for as long as the electrostatic generator was in operation).

Since the moving elements in the above described motors were charged by contact, the motors may be classified as "contact motors". This method of charging, however, is neither the only possible nor the most expedient one. Therefore contact motors will probably always be subordinate to most of the motors described in the following chapters. In this connection it may be useful to note that, upon a closer examination of the operation of Gordon's bells and other similar devices, one recognizes that the charging of the moving elements in these devices usually occurs by means of a spark that jumps from a stationary electrode (bell) to a moving element (clapper) as soon as the latter comes close

enough to the former. Thus the actual physical contact between the moving and stationary components in these devices is not at all necessary for their operation. In fact, such a contact is harmful insofar as it results in energy losses from impact and friction.

REFERENCES

1. P. Benjamin, *A History of Electricity*, John Wiley and Sons, New York, 1898, pp. 506, 507.
2. J. Sparks, Ed., *The Works of Benjamin Franklin*, Whittemore, Niles, and Hall, Boston, 1856, Vol. 5, p. 301.
3. F. M. Avery, *Modern Electricity and Magnetism*, Sheldon and Company, New York, 1885, p. 241.
4. A. Neuburger, *Ergötzliches Experimentierbuch*, Ullstein & Co., Berlin, 1920, pp. 434-436.
5. Gilbert, *Annalen der Physik*, Ser. 1, Vol. 49, pp. 35-46, (1815).
6. Müller-Pouillet, *Lehrbuch der Physik und Meteorologie*, Friedrich Vieweg und Sohn, Braunschweig, 1909, 10th edn., Vol. 4, p. 338.
7. H. B. Dailey, *Modern Electrics*, Vol. 5, pp. 916-917 (1912).
8. M. Guyot, *Nouvelles Recreations Physiques et Mathematiques*, Gueffier, Paris, 1786, Vol. 1, pp. 272-274 and Plate 27.

3

ELECTRIC WIND MOTORS

As already mentioned in the preceding chapter, Andrew Gordon invented two electric motors. His second motor was the "electric fly",^{1,2} also known as the "electric whirl", "electric pinwheel", or "electric reaction wheel" (Fig. 10). The electric fly consisted of one or more light metal arms with sharp-point ends bent at right angles to each arm and in the same circumferential direction. The fly was pivoted at its center on an insulated needle. When the needle was connected to an electrostatic generator, a corona discharge* took place from the sharp points of the fly. The air near these points became charged with charges of the same polar-

*Corona discharge is a spontaneous electric conduction in a gas (air) originating from sharp conducting bodies whose electrostatic potential relative to the ground is 3000 volts or higher.

ity as that of the fly and was then repelled from the points due to repulsion of like charges (the resulting motion of the air is known as the "electric wind"). Similarly, the points themselves were repelled from the charges in the air, and the fly rotated therefore in the opposite sense to that in which the points were directed.

Also the electric fly was used for ringing bells or chimes. This was accomplished by suspending from the fly a clapper, which, as the fly rotated, struck in turn several bells positioned in a circular formation underneath the fly (Fig. 11).³

In 1760, Hamilton, professor of philosophy at Dublin, suggested to use a similar device as an electrometer.⁴ In this electrometer small weights were suspended from the fly. As the fly turned, the weights were deflected from the vertical direction by centrifugal forces. This deflection was a measure of the fly's speed and, hence, of the strength of the source to which the fly was connected. A more sophisticated electrometer utilizing the electric fly was described by Jakob Langenbucher,⁵ a silversmith at Augsburg, Germany, who spent a large part of his time and fortune on improving electrostatic generators and studying electrostatic phenomena. In this electrometer the fly was mounted on a thin vertical cylinder. A fine string was fastened to the cylinder. The string passed over a small pulley and had a light pan attached to its free end. A small weight was placed on the pan. As the fly turned, the string

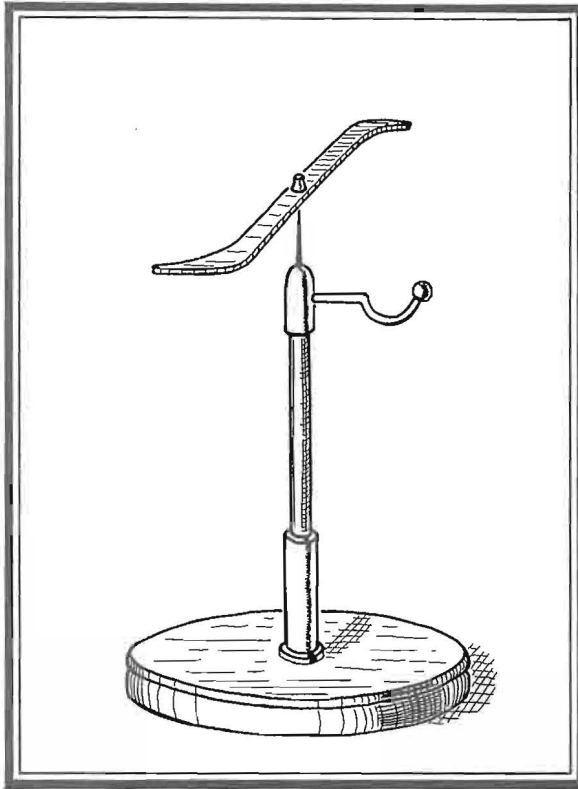

FIGURE 10

Andrew Gordon invented two electric motors. His second motor was the so-called "electric fly".

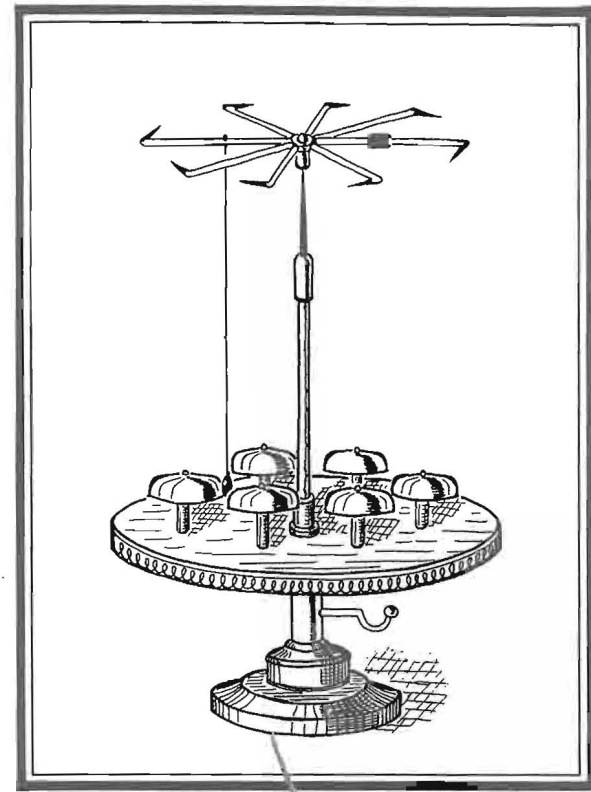

FIGURE 11

Also the electric fly was used for ringing bells with the aid of a clapper suspended from it.

wound itself on the cylinder lifting the pan and the weight. The maximum weight that could be lifted by this electrometer was a measure of the strength of the source from which the fly was operated.

The principle of the electric fly was later used to operate an orrery depicting the orbital motions of the Sun, the Moon, and the Earth (Fig. 12).⁶ In such an orrery, also known as the “electrical tellurium”, the longer bent arm carried a large sphere at one end, while at the other end it carried a similar but smaller bent arm, each end of which also carried a small sphere. The three spheres represented the Sun, the Moon, and the Earth. The arms were pivoted on sharp points, and each arm had a perpendicular sharp point in the horizontal plane. When the instrument was connected to an electrostatic generator, the two systems rotated about their points of support, the smaller system, being lighter, rotated more rapidly than the larger one. The relative masses of the spheres were adjusted to make the Earth-Moon system rotate twelve times for every single rotation of the Sun.

An interesting variation of the electric fly was constructed in 1761 by Ebenezer Kinnersley, a Philadelphia school teacher and close friend of Benjamin Franklin. Kinnersley called his device the “electrical horse-race”.⁷ This was a cross formed by two pieces of wood of equal length (probably about 18 inches long) supported horizontally on a central pin. A light figure of horse

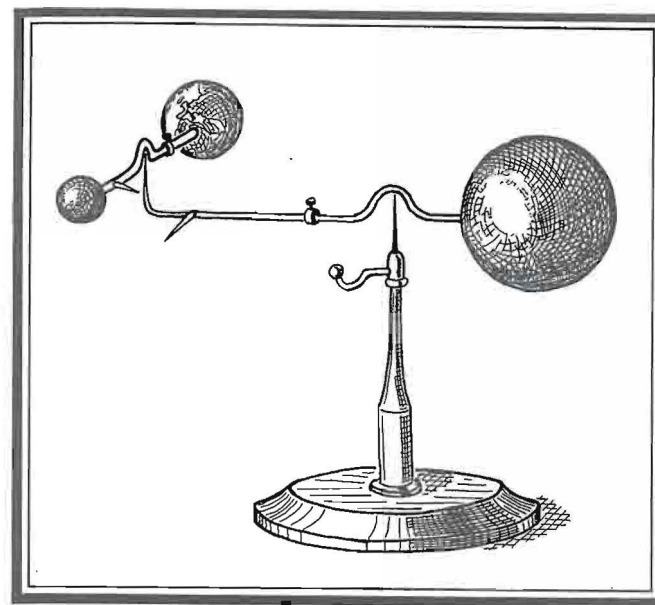

FIGURE 12

The principle of the electric fly was later used to operate an orrery depicting the orbital motions of the Sun, the Moon, and the Earth. The masses of the spheres were adjusted to make the Earth-Moon system rotate twelve times for every single rotation of the Sun.

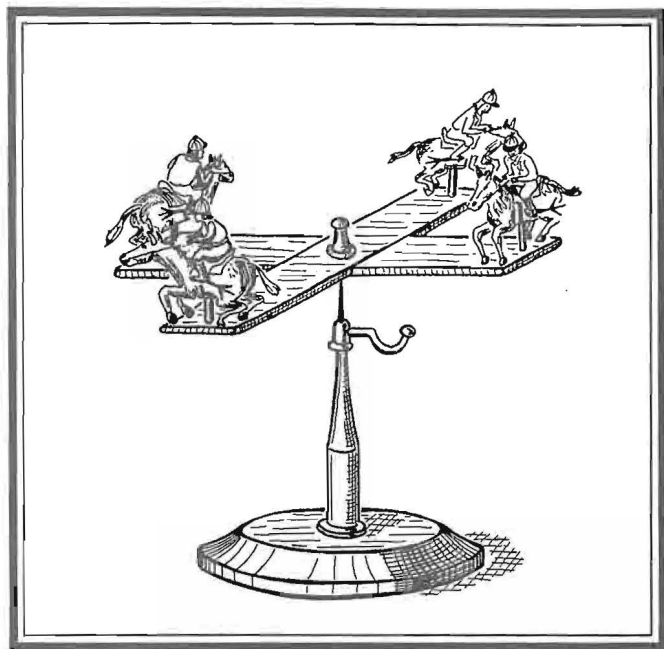

FIGURE 13

An interesting variation of the electric fly was constructed in 1761 by Ebenezer Kinnersley, a friend of Benjamin Franklin. Kinnersley called his device the "electrical horse-race". The electrical horse-race was a popular toy in the latter part of the 18th century.

with his rider was placed upon each extremity of the cross. The motion was produced by corona discharge from the spurs of the riders (Fig. 13). The electrical horse-race was a popular toy in the latter part of the 18th century. Interesting descriptions of this toy have been provided by Langenbucher (Ref. 5, p. 206 and Plate 8), and by Guyot.⁸

To show more convincingly that the electric fly converted electrical energy into mechanical energy, electric flies were placed on horizontal axes and were arranged to lift small weights (Fig. 14)⁹ or to climb inclined rails (Fig. 15).⁹

Operation of the electric fly in liquids was investigated by Aimé.¹⁰ A historical account of electric fly studies was presented by Tomlinson.¹¹ The mechanism of the fly was discussed at some length by Mascart.¹² A quantitative study of the forces acting upon the electric fly was performed by Kämpfer.¹³

A more efficient modification of the electric fly was proposed in 1887 by Bichat.¹⁴ Bichat's electric "tourniquet" consisted of a light vertical frame capable of turning about a vertical axis and supporting two thin vertical wires producing a corona discharge along their entire length. The vertical sides of the frame acted as "spoilers" preventing a corona discharge from the "back side" of the wires. A simple motor based on Bichat's device is shown in Fig. 16.

In recent years the principle of the electric fly (reaction force experienced by a sharp point as a

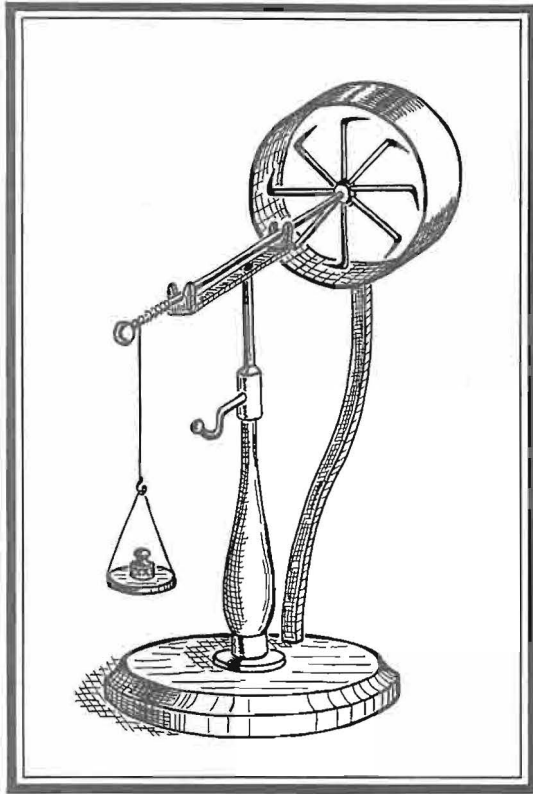

FIGURE 14

Electric fly converted electrical energy into mechanical energy and could lift small weights.

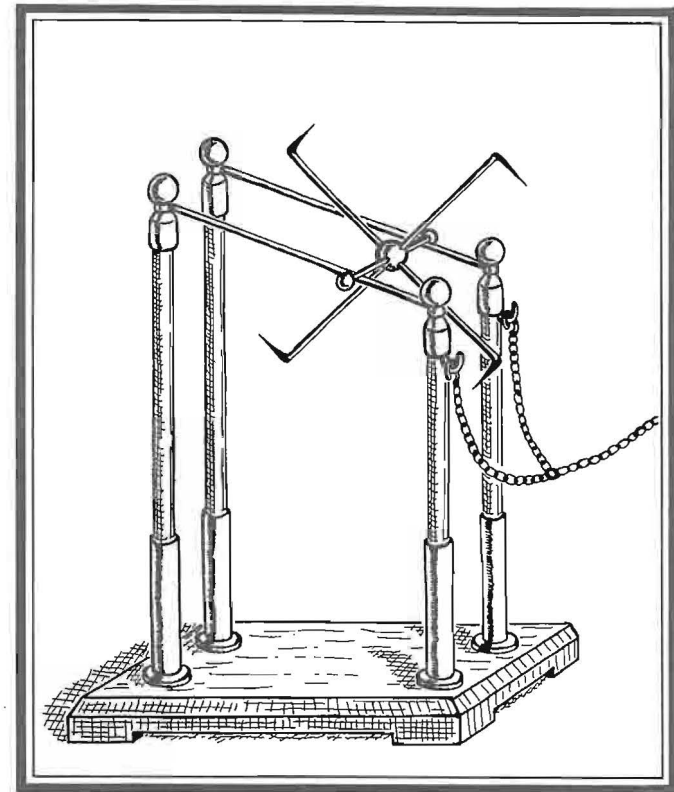

FIGURE 15

Electric fly developed enough mechanical energy for climbing inclined rails.

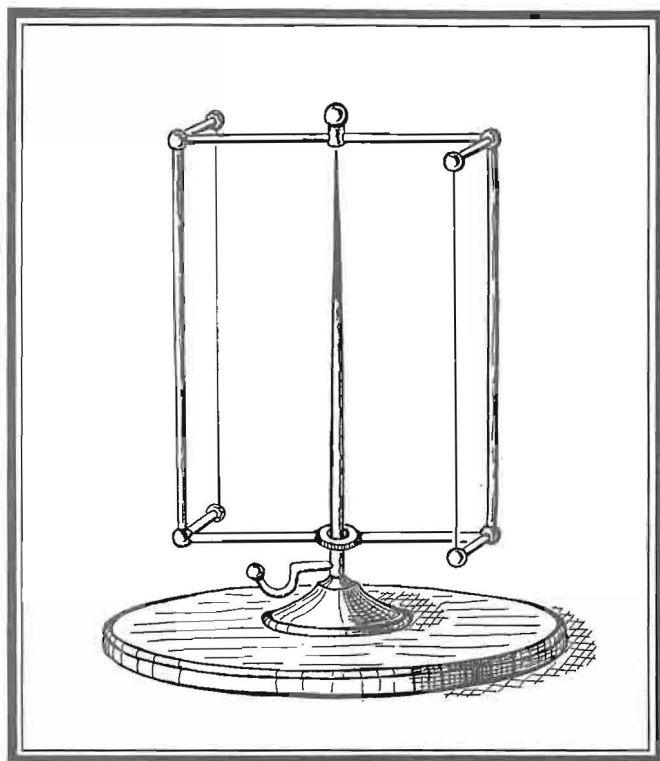

FIGURE 16

A more efficient modification of the electric fly was proposed in 1887 by Bichat, who called his device the "electric tourniquet".

result of a corona discharge from it) has been suggested for a flying machine ("corona-kraft levitation").¹⁵ The lift realizable from such a machine does not, however, appear to be of practical significance.¹⁶

Closely related to the electric fly were the "electric wind wheels" and the "electric wind turbines". Like the electric fly, they were invented in the 1740's and utilized a corona discharge from sharp points for their operation. Benjamin Franklin studied these devices in 1747 (he first learned of them from his friend Philip Syng). According to Franklin (Ref. 7, p. 184) they were "light windmill-wheels made of stiff paper vanes; also... little wheels, of the same matter, but formed like water-wheels". Their probable appearance was as shown in Figs. 17 and 18. Later versions of these devices have been described by Guyot (Ref. 8, pp. 274, 275 and Plate 27), by Langenbucher (Ref. 5, pp. 75, 76 and Plate 3), by Gale,¹⁷ and by Neuburger.¹⁸

A delightful electric toy using the electric wind for its propulsion was made by W. R. King, an associate of James Wimshurst (the designer of the electrostatic machine carrying his name). This toy, which may be called an "electrical rabbit hunt", now at the Science Museum in London, is shown in a simplified form in Fig. 19. It consists of a small electric wind turbine mounted on a vertical shaft carrying five light metal arms on its upper end; the arms support

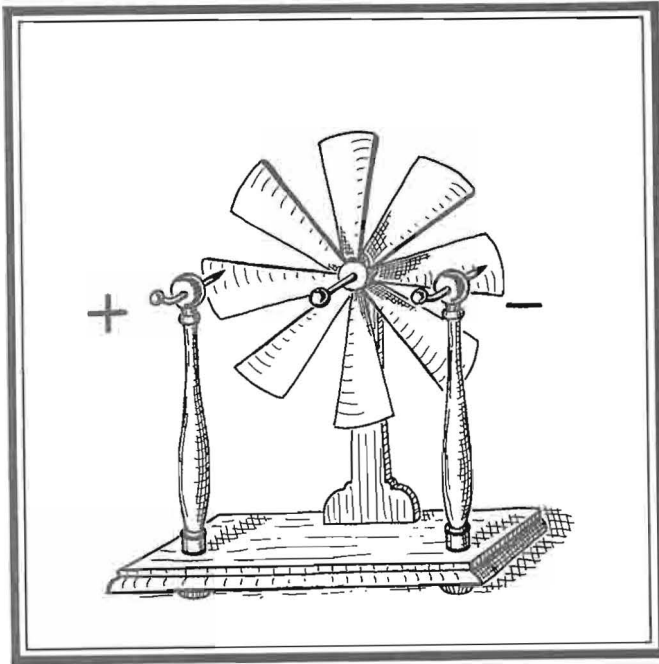

FIGURE 17

Closely related to Gordon's electric fly was the "electric wind wheel". Like the electric fly, it was invented in the 1740's and utilized a corona discharge from two sharp points for its operation.

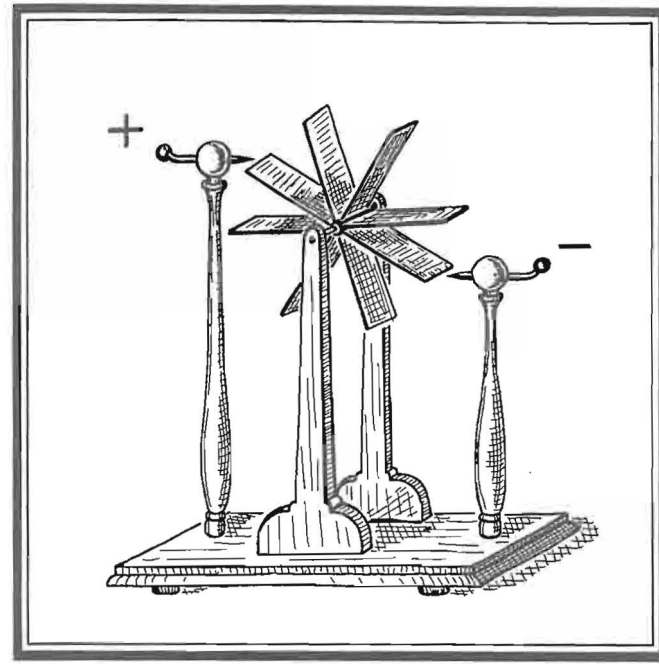

FIGURE 18

Benjamin Franklin studied this "electric wind turbine" in 1747. He concluded that its action depended not as much on the electric wind as on the forces between the charges present on its moving and stationary parts.

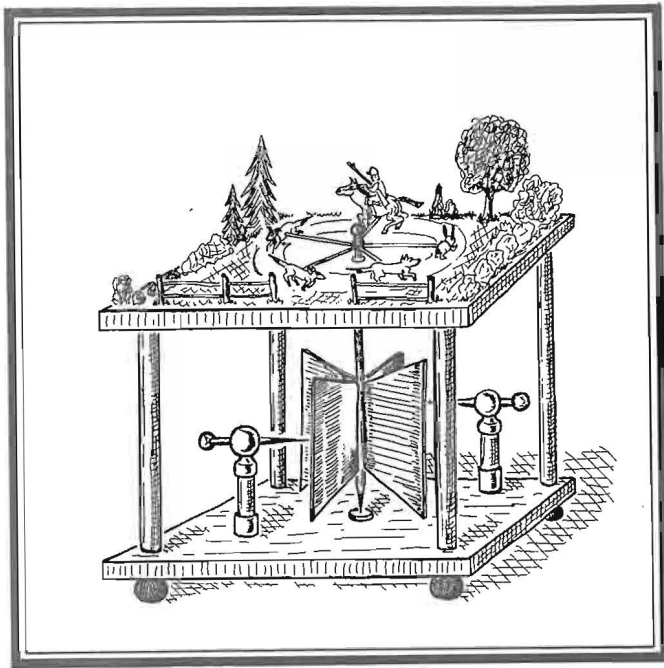

FIGURE 19

A delightful electric toy utilizing the electric wind for its propulsion was made by E. R. King, an associate of James Wimshurst. This toy, which may be called an "electrical rabbit hunt", is now at the Science Museum in London.

figurines of a rabbit, three dogs, and a horse-man, who chase each other in a beautiful little garden, as the arms turn powered by the turbine below.

In studying the electric wind motors, Benjamin Franklin concluded that their action depended not as much on the electric wind as such, but on the repulsion and attraction of electric charges present on the moving and stationary parts of the motors (Ref. 7, p. 184). It is very probable that this conclusion led him to the invention of his big electric motors, the famous "electrical wheels", which are described in the next chapter.

REFERENCES

1. P. Benjamin, *A History of Electricity*, John Wiley and Sons, New York, 1898, pp. 506, 507.
2. J. C. Poggendorff, *Geschichte der Physik*, Johann A. Barth, Leipzig, 1879, p. 846.
3. V. K. Chew, *Physics for Princes*, Her Majesty's Stationery Office, London, 1968, p. 13.
4. B. Wilson, *Philosophical Transactions*, Vol. 51, p. 896 (1760).
5. J. Langenbucher, *Beschreibung einer beträchtlich verbesserten Elektrisiermaschine*, Mathäus Reigers, Augsburg, 1780, pp. 54-56 and Plate 3.
6. G. Adams, *An Essay on Electricity*, London, 1799, 5th edn., pp. 580-581 and Plate 4.

7. J. Sparks, Ed., *The Works of Benjamin Franklin*, Whittemore, Niles, and Hall, Boston, 1856, Vol. 5, p. 371.
8. M. Guyot, *Nouvelles Recreations Physiques et Mathematiques*, Gueffier, Paris, 1786, Vol. 1, pp. 249, 250 and Plate 25.
9. H. J. Oosting, *Zeitschrift für den Physikalischen und Chemischen Unterricht*, Vol. 9, pp. 84-85 (1896).
10. R. Aimé, *Annales de Chimie et de Physique*, Ser. 2, Vol. 62, p. 421 (1833).
11. C. Tomlinson, *Philosophical Magazine*, Ser. 4, Vol. 27, p. 202 (1864).
12. M. E. Mascart, *Traité d'Electricité Statique*, G. Masson, Paris, 1876, Vol. 1, pp. 175-179.
13. D. Kämpfer, *Annalen der Physik*, Ser. 3, Vol. 20, pp. 601-614 (1887).
14. E. Bichat, *Annales de Chimie et de Physique*, Vol. 12, pp. 64-79 (1887).
15. A. Christenson and S. Moller, *AIIA Journal*, Vol. 5, pp. 1768-1733, (1967).
16. L. B. Loeb, *Electrical Coronas*, University of California Press, Berkley, 1965, pp. 402-406.
17. L. D. Gale, *Elements of Natural Philosophy*, Mark H. Newman, New York, 1846, p. 164.
18. A. Neuburger, *Ergötzliches Experimentierbuch*, Ullstein & Co., Berlin, 1920, pp. 432, 433.

4

FRANKLIN'S SPARK MOTORS AND THEIR DESCENDANTS

If one defines the "electric motor" as a machine capable of converting substantial amounts of electrical energy into mechanical energy, then it was Benjamin Franklin who invented the electric motor, for he was the first person to design and to construct a machine capable of accomplishing such a conversion.

Franklin built two electric motors, which he called "electrical wheels". He described them in a letter to Peter Collinson, Fellow of the Royal Society of London, written in Philadelphia in 1748.¹

His first motor was a big machine, about 40 inches in diameter. The main part of this motor was a wooden disk mounted horizontally on a vertical wooden axle and carrying 30 glass spokes with brass thimbles on their ends (Fig. 20 and Plate 2). The axle turned on a sharp point of

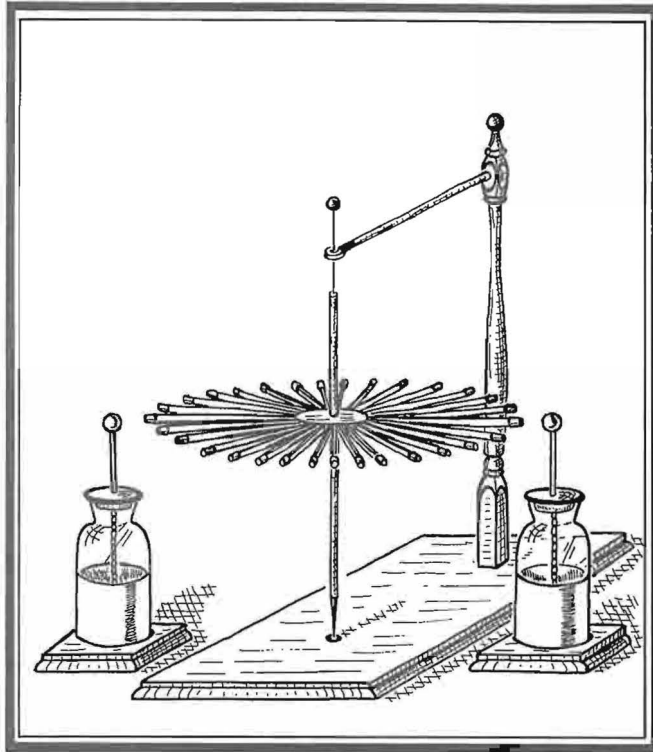

FIGURE 20

Franklin's first "electrical wheel" was the earliest device converting substantial amounts of electrical energy into mechanical energy.

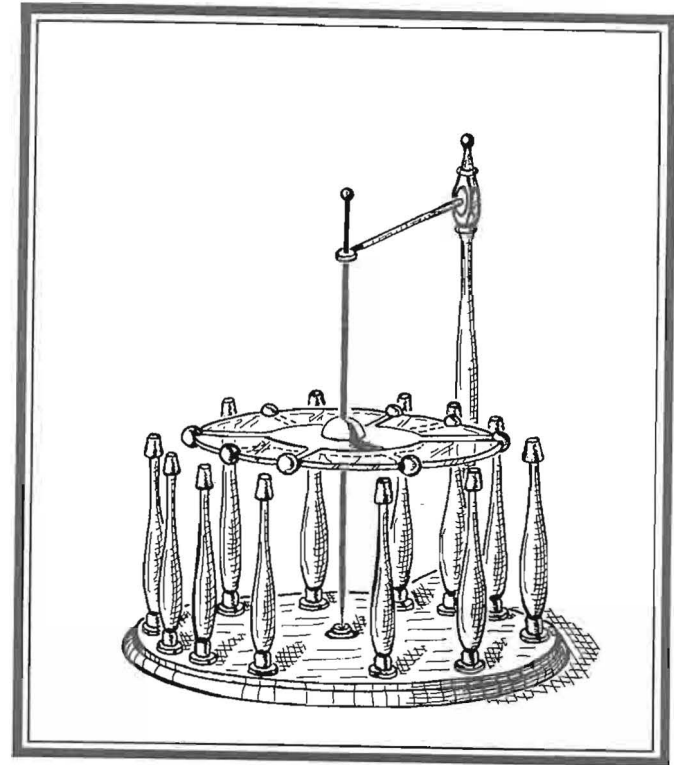

FIGURE 21

Franklin's second "electrical wheel" was more efficient than the first. It was powered by the electric charge stored in its capacitor-rotor.

iron fixed in its lower end and was kept in the vertical position by a strong wire mounted in its upper end and passing through a small hole in a thin stationary brass plate. Two oppositely charged Leyden jars (bottles) were placed in close proximity to the thimbles on the spokes, so that when the wheel turned, the thimbles barely missed the knobs of the jars.

As the thimbles moved past the Leyden jars, a spark jumped between a jar knob and the passing thimble, charging the latter with a charge of the same polarity as that of the knob. Therefore each knob attracted the oncoming thimbles ("opposite charges attract") and repelled the departing thimbles ("like charges repel"), causing the motor to turn. The motor, being perfectly symmetric, could turn in either direction, and usually required a starting push by hand to initiate the charging of the thimbles.

Here is how Franklin himself described the operation of his motor:¹

"If now the wire of a bottle, electrified in the common way, be brought near the circumference of this wheel, it will attract the nearest thimble, and so put the wheel in motion; that thimble, in passing by, receives a spark, and thereby being electrified, is repelled, and so driven forwards; while a second being attracted, approaches the wire, receives a spark, and is driven after the first, and so on till the wheel has gone once round, when the thimbles before electrified approaching the wire, instead of

being attracted as they were at first, are repelled, and the motion presently ceases. But if another bottle, which had been charged through the coating (e.i. charged oppositely to the first, O. J.), be placed near the same wheel, its wire will attract the thimble repelled by the first, and thereby double the force that carries the wheel round; and, not only taking out the fire (electric charge, O. J.) that had been communicated to the thimbles by the first bottle, but even robbing them of their natural quantity, instead of being repelled when they come again towards the first bottle, they are more strongly attracted, so that the wheel mends its pace, till it goes with a great rapidity, twelve or fifteen rounds in a minute, and with such strength, as that the weight of one hundred Spanish dollars, with which we once loaded it, did not seem in the least to retard its motion".

Franklin was not quite pleased with this motor, however, because it required "a foreign force, to wit, that of the bottles" for its operation. He constructed therefore a second, "self-moving", motor, which itself contained the electrical energy to be converted into the mechanical motion.

The second motor was made as follows (Fig. 21 and Plate 3). A disk of window glass, 17 inches in diameter, was gilded on each side, except for narrow areas next to the edge. Several lead spheres (bullets) were fixed to the edge of the disk and were connected in alternation to

the two gold layers. The disk was mounted on a vertical axle consisting of two pieces of strong wire, each about 9 inches long; the upper wire being in contact with the top layer of gold, the lower wire being in contact with the bottom layer. The lower wire terminated in a sharp point resting on a piece of brass cemented within a glass salt-cellar. The upper wire passed through a hole in a thin brass plate cemented on a long strong piece of glass. This wire carried a small ball on its upper end for preventing a corona discharge from it. Several glass pillars with thimbles on their tops were positioned in a circle around the disk, so that the spheres on the edge of the disk barely missed the thimbles when the disk was in motion. The motor was powered by electricity stored in the disk itself, which, due to the two layers of gold, constituted a capacitor capable of storing an appreciable quantity of charge (to charge the rotor, the two layers of gold were temporarily connected to an electrostatic friction generator).

The motor operated on the same principle as Franklin's first motor, except that now the thimbles were stationary and received positive or negative charges from the passing spheres, rather than the other way around. As in the first motor, the rotation persisted as long as there was enough charge stored in the capacitor (rotor) to produce sparks between the spheres and the thimbles.

Franklin reported that his second motor

(which was more powerful than the first one) could make 50 turns in a minute and could run for up to 30 minutes on a single charging of the rotor.¹ Experiments with replicas of Franklin's motors performed by the author indicate that the original motors developed a power of the order of 0.1 watt,^{2,3} which was a very impressive achievement for that very early period in the history of electric science.

Several authors have described simplified versions of Franklin's motors.^{4,5} Miniature Franklin-type motors have been constructed and described by A. D. Moore⁶ (Fig. 22). One such motor consists of a Plexiglas disk about 4 inches in diameter with small conducting balls embedded in the rim. The disk turns on a horizontal axis supported by a base behind the disk. The motor runs when placed between two conductors connected to an electrostatic generator. To make the motor self-starting and one-way running, the conductors may be provided with short auxiliary rods tangential to the disk; since the rods dispatch sparks predominantly in the direction of their free ends, the disk also turns in this direction. Another little motor of the same type designed by Moore is shown in Fig. 23.

An obvious improvement of Franklin's motors would be to use a cylindrical rotor with electrodes in the shape of long strips. Such electrodes would accept more charge than thimbles or spheres, and the power of the motor would be increased considerably. Motors of this type

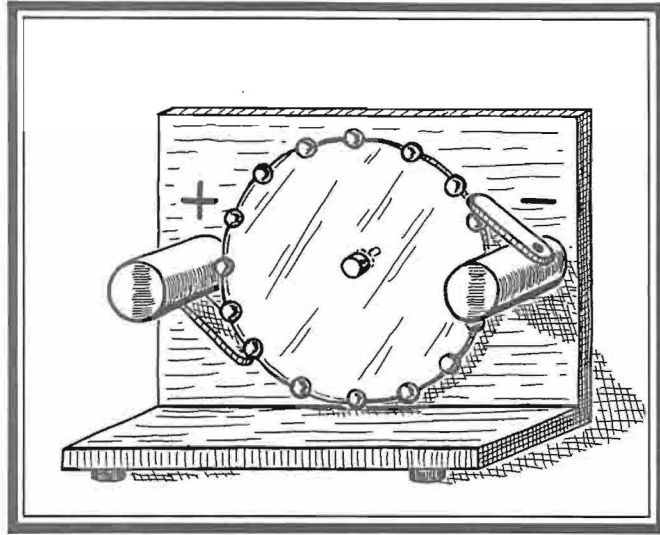

FIGURE 22

Several authors have described simplified versions of Franklin's motors. One such motor consists of a Plexiglas disk about 4 inches in diameter with small conducting balls embedded in the rim. The disk turns on a horizontal axis supported by a base behind the disk.

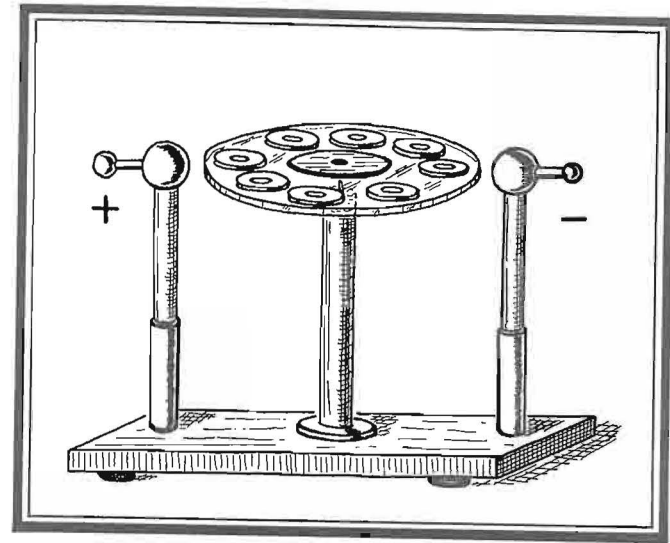

FIGURE 23

This inexpensive miniature Franklin-type motor of recent design can be used for lecture-room demonstrations of electrostatic forces. The rotor disk can be made from cardboard, wood, or plastic. For the rotor electrodes one can use thumbtacks or small aluminum foil disks.

have indeed been constructed. Here is a description of a "bell jar" motor taken from a book published in 1847 (Fig. 24):

"On a pivot, *a*, suspend a bell jar having four pieces of tinfoil pasted on its sides, *b*, *c*, *d*; connect the jar, by means of the insulated wire, *y*, with the prime conductor (high-voltage terminal of an electrostatic friction generator, O. J.) so that the pieces of tinfoil may receive sparks. On the opposite side arrange a conductor, *x*, in connection with the ground by a chain. On putting the machine into activity, the jar will commence rotating on its pivot."⁷

Small motors closely related to both Franklin's first motor and to pendulum motors were used in the rotary-type "perpetuum mobile" (see Chapter 2) operated from a Zamboni pile.⁸ The main part of these motors (Fig. 25) was a light insulated arm pivoted on a sharp point and carrying a piece of tinsel on each end. The tinsels could just touch the knobs of the pile when the arm was moving on its pivot. The device functioned in the same manner as Franklin's first motor, the two tinsels corresponding to the thimbles of the latter.

An analogous design has recently been described as a "millifluepower motor" operating from a nuclear battery.⁹ In this motor a light aluminum vane with pointed ends (Fig. 26) bent so as to form an inverted V is mounted at its midpoint on the tip of a sharp needle protruding from the positive terminal of the battery. As the

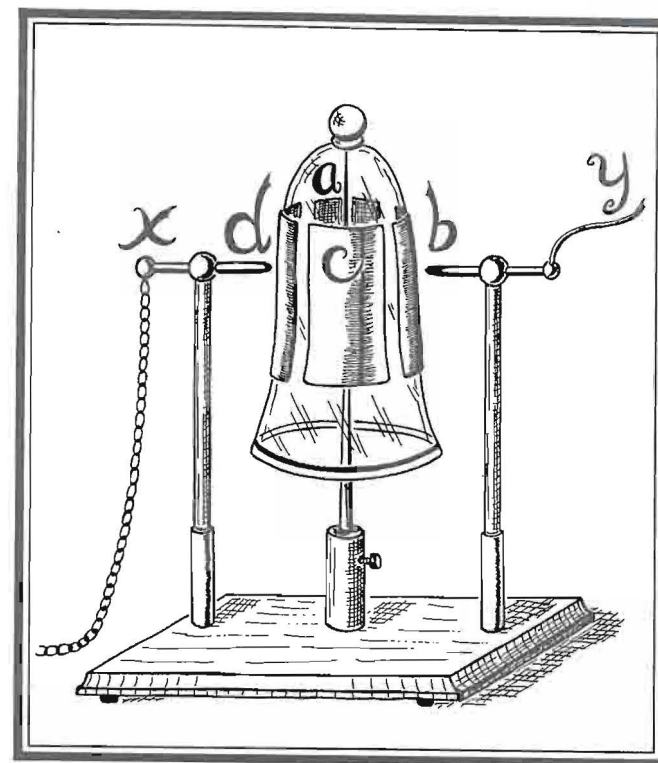

FIGURE 24

This "bell jar" Franklin-type motor had a cylindrical rotor with tinfoil electrodes in the shape of long strips.

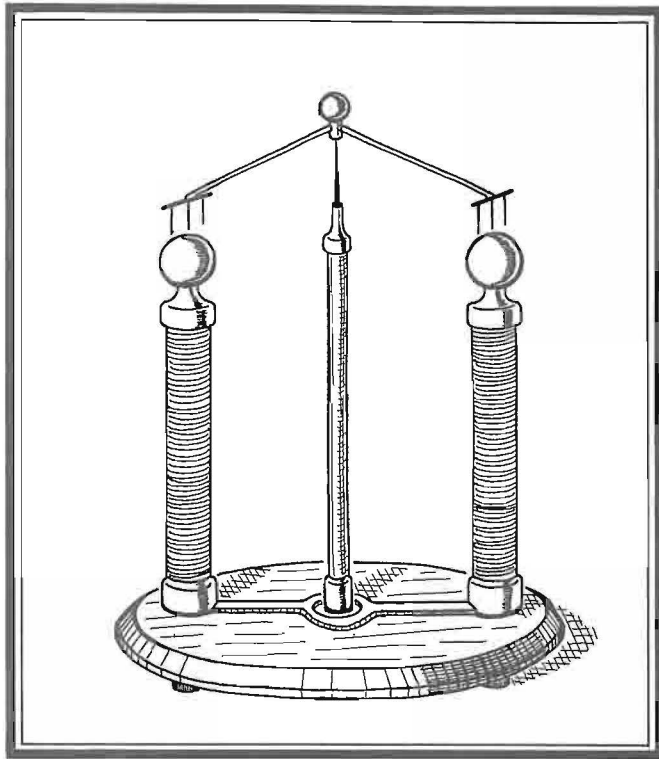

FIGURE 25

This small motor was used as a rotary-type "perpetuum mobile" operating from a Zamboni pile. Such motors turned for years without stopping.

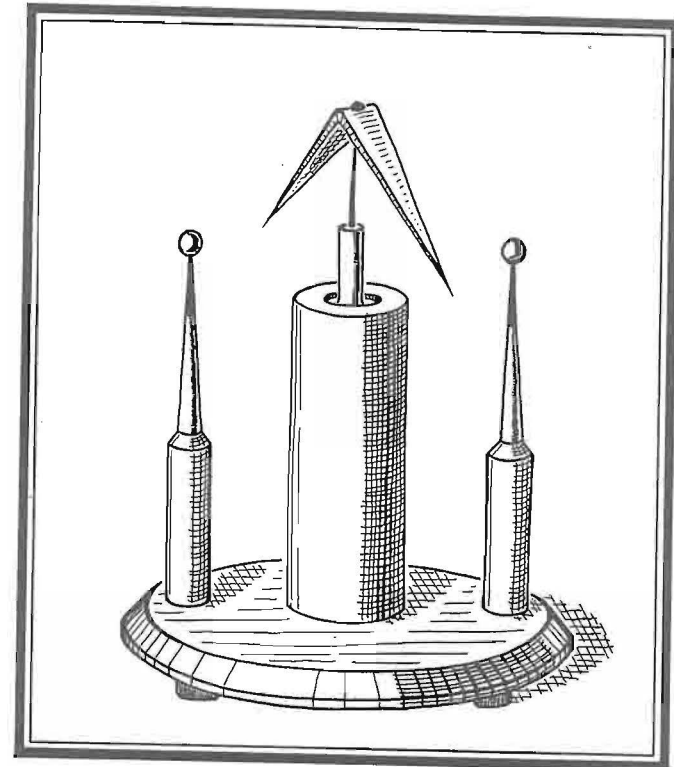

FIGURE 26

An analogous design has recently been described as a "milliflpower motor" operating from a nuclear battery.

vane turns, its ends come close to two spheres connected with the ground through a high resistance and become attracted by them. A discharge from the ends of the vane charges the two spheres, and the spheres then repel the ends of the vane. During the time it takes the vane to complete one half of its revolution, the charges of the spheres leak off to the ground, so that the spheres can again attract the ends of the vane, accept new charges from them, and then again repel them. The motor is expected to run for many years.

An interesting motor derivable from Franklin's first motor and from pendulum motors was suggested for operation from an electrophorus.¹⁰ The main part of this motor (Fig. 27) was a light conducting ring supported in a vertical plane on an insulated needle. In front of the ring there were two insulated spheres, which were so positioned that the ring just missed them as it turned on its needle. The spheres were either charged oppositely by the electrophorus, or only one sphere was charged, in which case the second sphere was grounded. The device operated on the same principle as Franklin's first motor.

Of all the motors discussed above, Franklin's original motors and the bell jar motor were the most powerful ones. One can make such motors even more powerful by increasing the number of moving and stationary electrodes. But this can be done only up to a limit, because if the electrodes are too close to one another, sparks will

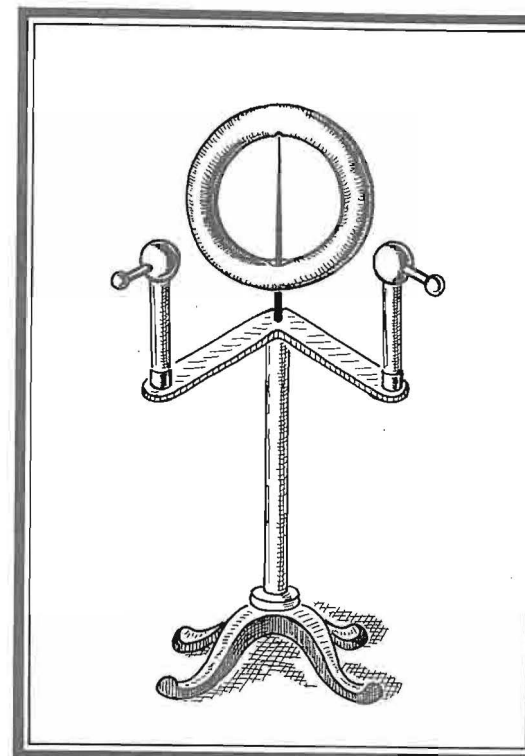

FIGURE 27

This motor derivable from Franklin's first motor and from pendulum motors was suggested for operation from an electrophorus.

jump all around from one electrode to the next, thus short-circuiting the motor. The motor will then not work at all, unless the operating voltage is lowered. But by lowering the voltage one also lowers the power, so that the gain obtained by increasing the number of electrodes becomes offset by the decrease in the operating voltage. Franklin type motors have therefore an inherent limitation in their power characteristics, and the fact that they depend for their operation on the presence of many metallic electrodes is one of their disadvantages.

Since in Franklin's motors and in other motors described in this chapter the rotor is charged by means of electric sparks, these motors may be classified as "spark motors". Toward the end of the 19th century a way was found to construct electrostatic motors based on the same mechanism of attraction and repulsion between electric charges as in Franklin's motors, but with rotors (or stators) charged more efficiently than it is possible to do by means of the sparks. These motors are described in the next chapter.

REFERENCES

1. J. Sparks, Ed., *The Works of Benjamin Franklin*, Whittemore, Niles, and Hall, Boston, 1856, Vol. 5, pp. 204-207.
2. O. Jefimenko and D. K. Walker, *The Physics Teacher*, Vol. 9, pp. 121-129 (1971).
3. O. Jefimenko, *American Journal of Physics*, Vol. 39, pp. 1139-1140 (1971).

4. M. Guyot, *Nouvelles Recreations Physiques et Mathematiques*, Gueffier, Paris, 1786, Vol. 1, pp. 272-274 and Plate 27.
5. Dayton C. Miller, *Sparks, Lightning, Cosmic Rays*, MacMillan, New York, 1939, pp. 63, 64.
6. A. D. Moore, *Electrostatics*, Doubleday and Company, Inc., New York, 1968, pp. 104-108.
7. J. W. Draper, *Text-Book on Chemistry*, Harper and Brothers, New York, 1847, p. 105.
8. M. J. Jamin, *Cours de Physique*, Gauthier-Villars, Paris, 1869, 2nd edn., Vol. 3, p. 39.
9. R. H. Dressel, *High School Science Bulletin of the New Mexico State University*, Vol. 6, pp. 3-4 (April 1, 1964).
10. H. Wommelsdorf, *Annalen der Physik*, Ser. 4, Vol. 70, pp. 135-138 (1923).

5

CORONA MOTORS AND MOTORS SIMILAR TO THEM

In 1867, W. Holtz, the inventor of the electrostatic "influence" machine (generator) carrying his name, discovered that this machine could function as a motor when powered by another similar machine.¹ In order to study this effect in some detail, the famous German physicist J. C. Poggendorff ordered the construction of a special device, analogous to Holtz's machine, but designed to operate only as a motor and provided with numerous adjustable components so as to operate under a wide range of conditions.²

The basic part of this motor was a vertical glass-disk rotor placed between two ebonite crosses carrying metallic sharp-needle "combs" (Fig. 28 and Plate 4). The sharp points of the combs almost touched the surface of the disk, so that the disk could be charged by means of a corona discharge from the combs when they were

connected in alternation to an electrostatic generator. Each comb could be oriented so as to make an arbitrary angle with respect to a radial direction.

Just like the sparks in Franklin's motors, the corona discharge from a comb deposited on the rotor a charge of the same polarity as that of the comb. Each comb repelled therefore the segment of the rotor carrying charges which it sprayed onto the rotor and attracted the segment carrying charges sprayed onto the rotor by the preceding comb. Because of a continuous discharge between the combs and the rotor, almost the entire surface of the rotor was sprayed with electric charges. The repulsion and attraction between the combs and the rotor, were therefore not only much stronger than in Franklin's motors, (where only the electrodes were charged) but were also much steadier, since the distances between the combs and the charges on the rotor were always the same. As a result, the torque and power obtainable with this motor were far greater than those obtainable with Franklin's motors of similar dimensions.

Poggendorff made a thorough study of his motor, varying all its important parameters (his article comprises 32 pages). He used several rotors of different thickness and surface characteristics, whose weight ranged from 2.5 to 4.5 pounds (all rotors were 15 inches in diameter). He varied the number, the orientation, and the polarity of the combs.

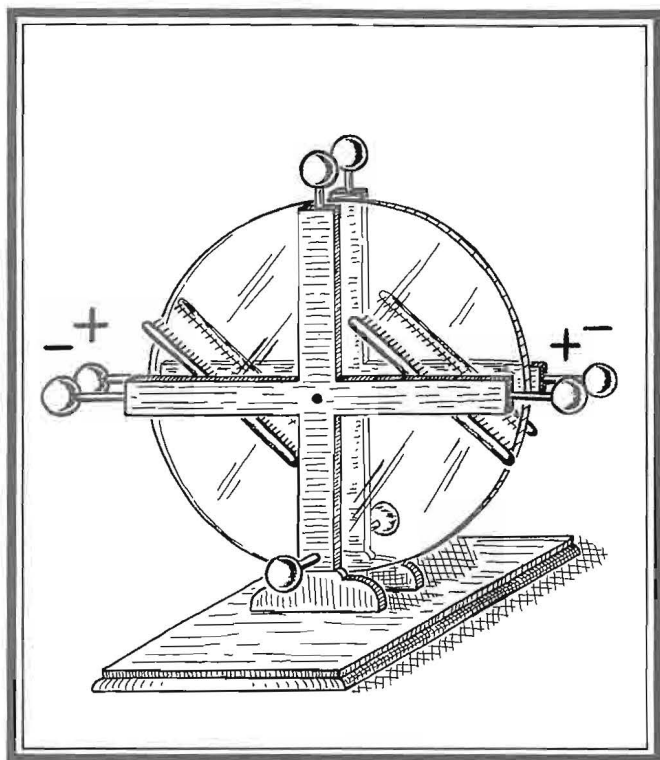

FIGURE 28

Poggendorff's corona motor had a glass-disk rotor placed between two ebonite crosses carrying metallic sharp-needle "combs".

He found that a motor with combs arranged along the radii of the rotor could rotate equally well in either direction but was not self-starting, since such combs sprayed charges onto the rotor in a perfectly symmetric fashion. However, if the combs were slanted relative to the radii, the motor became self-starting and unidirectional, because such combs sprayed charges predominantly in one direction. He also found that the performance of the motor could be improved by placing pieces of glass, cardboard, or metal close to the surface of the rotor (this is the principle of the modern "backing plate" or "lining"; see Chapter 10). When properly adjusted, the motor could run at better than 300 rpm.

Poggendorff had fully appreciated the superiority of his motor in comparison to Franklin's motors, and had stated so at the end of his article. In fact, he had indicated that his motor used from 1200 to 1800 times as much current as Franklin's motors, in which case, assuming that the operating voltage of his motor was the same as that of Franklin's motors (approximately 100 kilovolts), the power of his motor must have been close to 100 watts.

At the time when Poggendorff's article was written, however, it was considered unscientific to expect that electricity (*any* electricity) could ever become a significant source of motive power. This may be the reason why Poggendorff, speaking of the rotation phenomenon that he investigated, declared at the end of

his article: "...it would be a sanguine hope if one wanted to believe that any useful mechanical effect could be achieved with it. That this is not possible, follows already from the consideration of how small is the quantity of electricity that is here put into play in comparison to that developed by a voltaic battery, with which one nevertheless, even with the help of the magnetismus produced by it, has so far achieved nothing substantial ("Erkleckliches)". The argument was obviously weak, but taking into account Poggendorff's reputation as an eminent scientist, it was probably sufficient to discourage further serious investigations of the corona-induced rotation for many years to come.

Since Poggendorff's motor depended on a corona discharge for its operation, the motor may be classified as a "corona motor".

Holtz's rotation phenomenon was also studied by the Danish physicist C. Christiansen (whose interest in the phenomenon had been aroused by a preliminary report of Poggendorff's investigations published in 1867).³ Christiansen described two motors based on Holtz's discovery. His first motor consisted of a horizontal disk rotor and two stationary corona-producing combs. His second motor was similar to the first except that in it the glass disk was stationary and the combs constituted the rotor. The rotor combs in this second motor were located below the glass disk and were charged by means of two foil strips hanging from them and sliding along

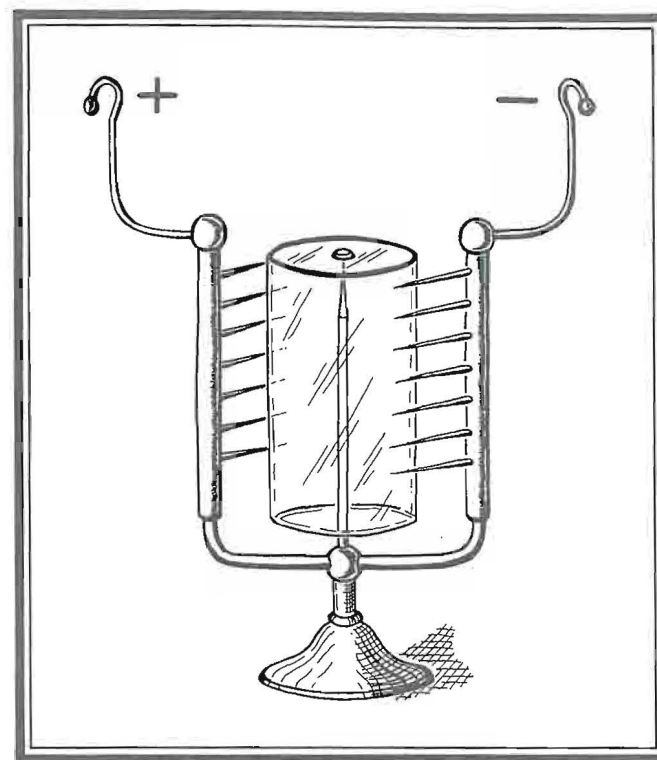

FIGURE 29

This self-starting corona motor with a cylindrical rotor was described in 1871 under the name of "electric tourbillion".

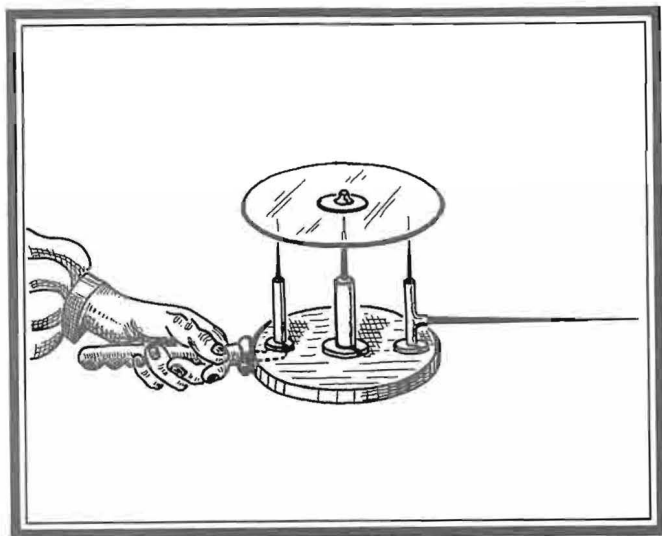

FIGURE 30

In this hand-held corona motor (attributed to Ruhmkorff) the horizontal wire, by a corona discharge, extracted charges from the power source, and the vertical needle connected to this wire, also by a corona discharge, sprayed these charges onto the rotor.

two horizontal concentric contact rings mounted on the base of the motor.

Cylindrical and spherical motors operating on the same principle as Poggendorff's motor were described in 1871 by W. Gruel (Fig. 29), who called them the "electric tourbillions".⁴ Gruel pointed out that these motors could be made self-starting and unidirectional by inclining the combs in the same rotational direction with respect to the surface of the rotor. He also suggested that by providing the rotors with a series of holes, the motors could be used as sirens.

A disk motor not noticeably different from Poggendorff's motor was patented in the U.S.A. in 1891 by J. W. Davis and J. B. Farrington.⁵

An interesting hand-held corona motor (attributed to Ruhmkorff) was described in 1876 by M. E. Mascart.⁶ The motor had a horizontal mica disk rotor (Fig. 30) supported on a vertical needle by a jewel bearing, such as are used for supporting compass needles. Below the disk there were two vertical corona-producing needles mounted on a hard rubber base. One of the latter needles was connected to a metal handle, the other was connected to a long, stiff, horizontal wire terminating in a sharp point. To set the motor in motion, the operator held the motor so that the sharp point of the horizontal wire was in the proximity of a charged conductor. By a corona discharge, the horizontal wire then extracted charges from the conductor, and the ver-

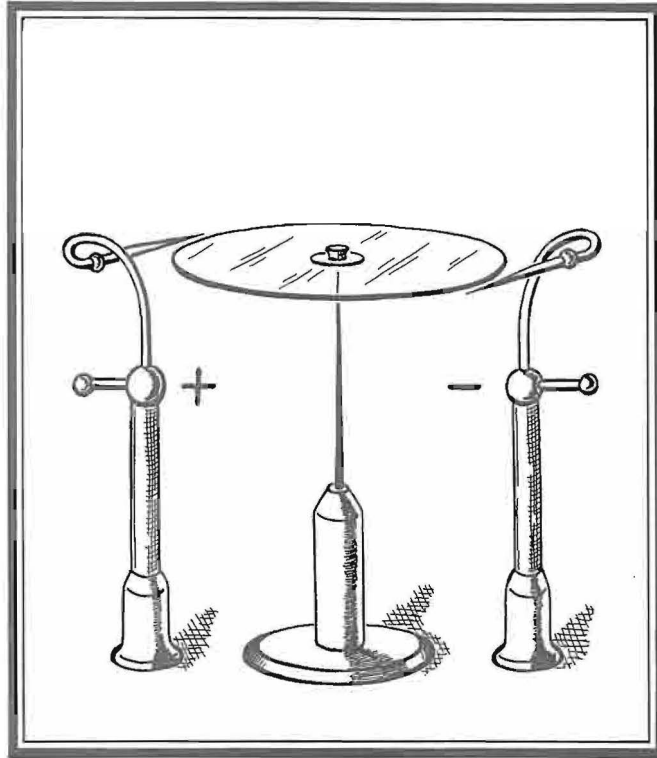

FIGURE 31

This motor had two insulated corona-producing points tangential to the rotor disk and oriented in the same rotational direction.

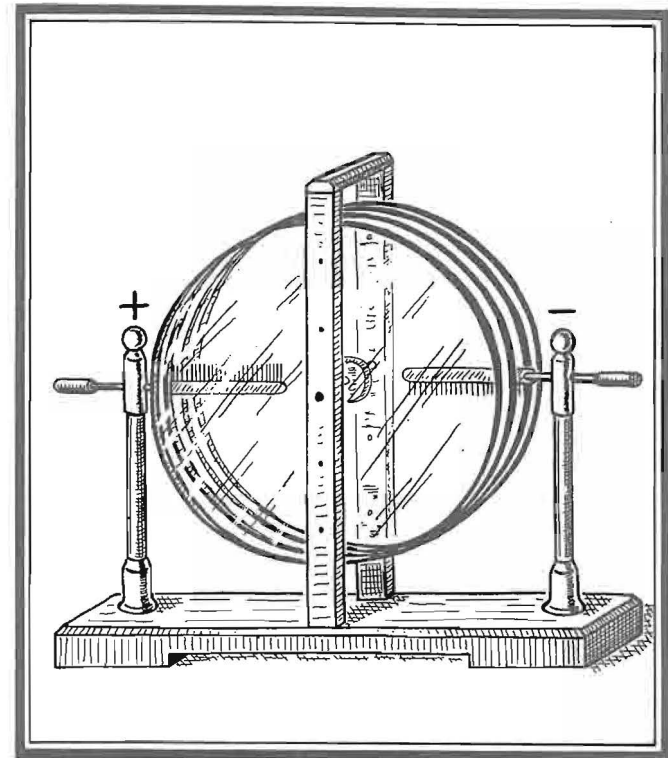

FIGURE 32

This corona motor with a compound glass rotor could run at about 2000 rpm and had a power of about 90 watts.

tical needle connected to this wire, also by a corona discharge, sprayed these charges onto the rotor. The second vertical needle discharged the rotor and conducted its charges to the ground through the hand and body of the operator.

A number of experiments with Poggendorff type corona motors were reported in 1921 by V. E. Johnson.⁷ One of his motors was similar to Ruhmkorff's motor (Fig. 31). This was a horizontal mica disk, about 6 inches in diameter, supported on a vertical needle point. At the edge of the disk there were two insulated corona-producing points tangential to the disk and oriented in the same rotational direction. Another of Johnson's motors was a big machine consisting of two stationary glass disks and a three-piece glass rotor that could rotate on ball bearings between the stationary disks. The rotor was made of two large glass disks separated by a smaller disk so as to have a deep slot along its edge. Two flat sharp-point combs were inserted diametrically opposite to one another into the slot of the rotor (Fig. 32). Johnson estimated that his motor could run at about 2000 rpm and had a power of about 90 watts.

Just as Poggendorff's motor was derived from Holtz's electrostatic machine, a series of electrostatic motors were similarly derived from Wimshurst's electrostatic machine.

In 1891 five such motors were constructed by William McVay of New York City.⁸ McVay's first motor (Fig. 33) consisted of two horizontal

glass disks, about 12 inches in diameter, one stationary and the other rotating on the vertical axis just above the first. The lower disk had two quadrants of tinfoil, and the upper disk had 16 tinfoil sectors, as shown in the figure. The power (from a Wimshurst machine) was delivered to the motor by means of two insulated arms, each of which terminated in two brushes, one touching continually one of the lower quadrants, the other charging a sector on the upper disk just clear of the edge of the quadrant. Charges of the same polarity were thus deposited on the quadrant and on the sector, causing them to repel each other. An "equalizer" reduced the charge of the sectors before they passed over the further edge of an oppositely charged quadrant, thus reducing the back torque on the rotating disk. An important new feature of this motor was the simultaneous charging of the stationary quadrants and of the moving sectors, which assured a relatively strong starting torque and, together with the neutralizing system, assured a reliable unidirectional operation. McVay also constructed motors of cylindrical geometry, one of which is shown in Fig. 34. In this motor the quadrants were located on the inner cylinder, while the charging and neutralizing brushes were on the neck of the outside cylinder.

McVay's first motor was later modified for charging by combs, rather than by brushes (Fig. 35). The motor then operated essentially as

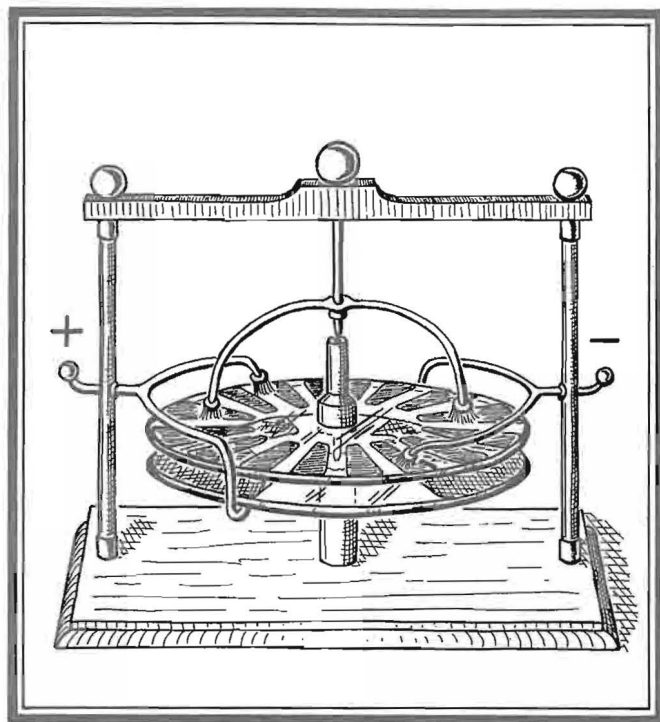

FIGURE 33

McVay's first motor consisted of two horizontal glass disks, about 12 inches in diameter, one stationary and the other rotating on the vertical axis just above the first.

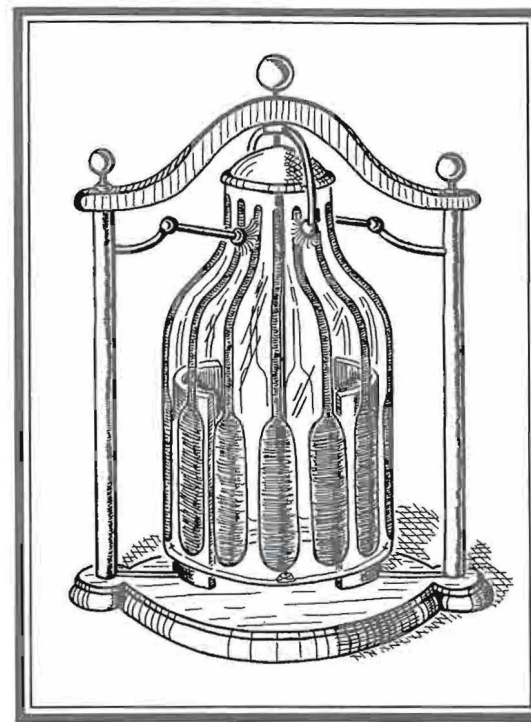

FIGURE 34

In this McVay's motor the quadrants were located on the inner cylinder (shown as two segments), while the charging and neutralizing brushes were on the neck of the outside cylinder.

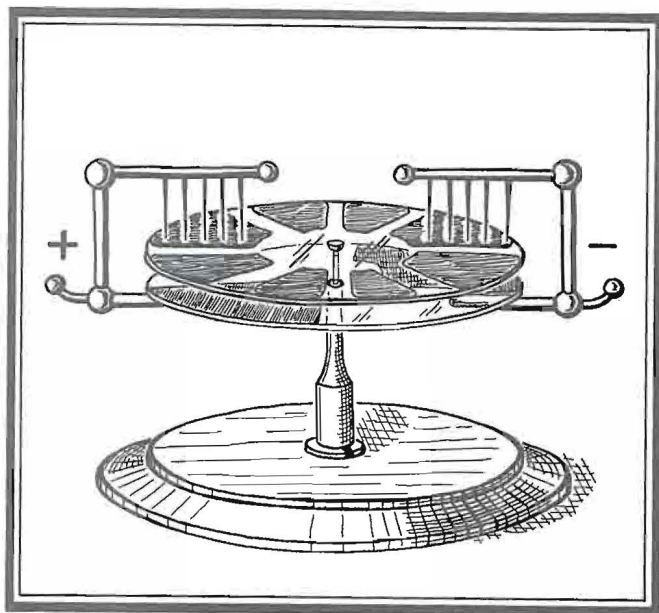

FIGURE 35

McVay's first motor was later modified for charging by combs, rather than by brushes. The motor then operated essentially as Poggendorff's corona motor, retaining, however, its self-starting and unidirectional qualities.

Poggendorff's corona motor, retaining, however, its self-starting and unidirectional qualities.

Instructions for building a Poggendorff motor may be found in the May 1971 issue of *Popular Science*.⁹ Instructions for building a simple McVay motor may be found in the January 1914 issue of *Electrical Experimenter*¹⁰ (the author is grateful to Mr. Thorn L. Mayes for this information).

Since a corona discharge in air at atmospheric pressure requires a minimum voltage of about 3000 volts, ordinary corona motors can operate only from sources capable of supplying a voltage of this magnitude. Such voltages are, of course, easily attainable at the present time, and since the corona motors are very simple and efficient devices, they have been further developed and studied in recent years. We shall return to them in the last chapter of this book.

REFERENCES

1. W. Holtz, *Annalen der Physik*, Ser. 2, Vol. 130, pp. 168-171 (1867).
2. J. C. Poggendorff, *Annalen der Physik*, Ser. 2, Vol. 139, pp. 513-546 (1870).
3. C. Christiansen, *Annalen der Physik*, Ser. 2 Vol. 137, p. 490 (1869).
4. "Elektrischer Tourbillion", *Annalen der Physik*, Ser. 2 Vol. 144, p. 644 (1871).
5. U. S. Patent No. 459678.

6. M. E. Mascart, *Traité d'Electricité Statique*, G. Masson, Paris, 1876, Vol. 1 pp. 179, 180.
7. V. E. Johnson, *Modern High Speed Influence Machines*, E. and F. N. Spon, London, 1921, pp. 175-205.
8. "A Group of Static Motors", *Electrical World*, Vol. 18, p. 418 (1891).
9. C. P. Gilmore and W. J. Hawkins, *Popular Science Monthly*, Vol. 198, pp. 95-97 and 114 (May 1971).
10. "A Static Electric Motor", *Electrical Experimenter*, January 1914, p. 137.

6

CAPACITOR MOTORS

In 1889, Karl Zipernowsky, a Hungarian engineer (co-inventor of practical electrical transformers), constructed a new type of electrostatic motor,¹ which was derived from Thomson's quadrant electrometer.² The rotor of this motor (Fig. 36) consisted of two pairs of aluminum sectors insulated from each other and from the rest of the apparatus. The stator consisted of four double (hollow) sectors of brass enclosing the rotor. The rotor was fitted with a commutator in four parts, by means of which the sectors of the rotor were charged oppositely to those sectors of the stator into which they were entering and identically to those sectors of the stator which they were leaving. An interesting property of this motor was that it could operate from high-voltage dc as well as from high-voltage ac sources.

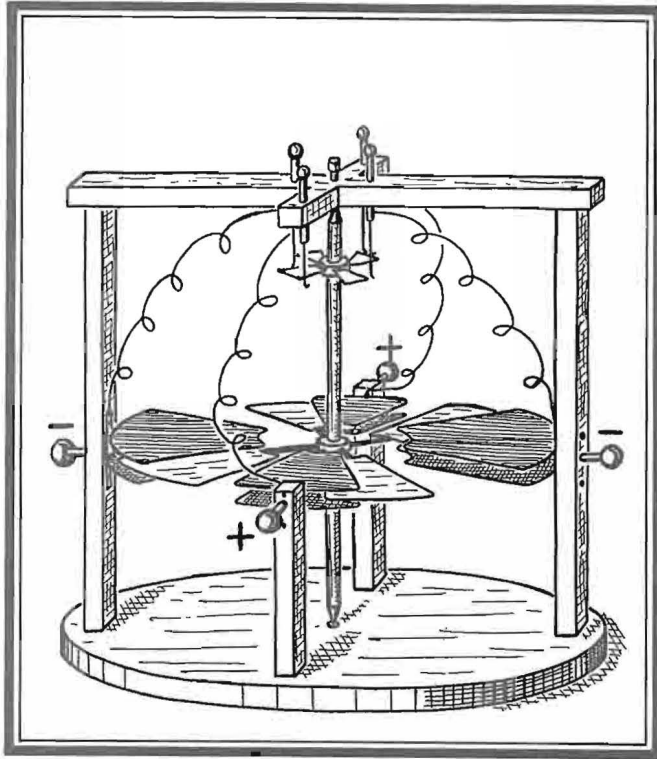

FIGURE 36

This motor was built in 1889 by Karl Zipernowsky, a Hungarian engineer. It operated from dc as well as from ac sources.

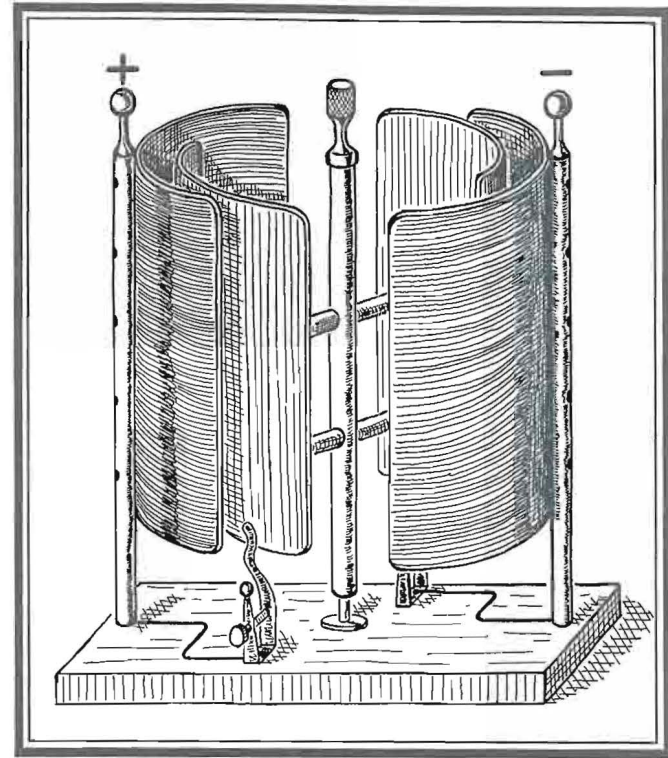

FIGURE 37

This capacitor motor was described in 1904 by van Huffel. Its rotor could be charged by contact or by sparks.

Inasmuch as Zipernowsky's motor operated as a result of the electric forces exerted by one charged conducting plate upon a second charged conducting plate (which are the same forces that act upon the two plates of a capacitor) it constituted what is now called an electrostatic "capacitor motor".

A simpler version of a capacitor motor was described in 1904 by van Huffel.³ This motor was based on the so-called Thomson's replenisher.⁴ The motor had an essentially cylindrical geometry (Fig. 37) and consisted of a rotor with two insulated bent brass plates mounted on a vertical axle and located between two similar, but slightly larger, plates of the stator. The rotor plates (which were not quite coaxial) were charged by means of two metallic tongues connected to the stator plates; the tongues touched the rotor plates just as the latter began to clear the stator plates. The charging of the rotor plates could occur by a direct contact as well as through a spark, depending on the adjustment of the tongues.

Since capacitor motors do not require sparks or a corona discharge for their operation, they can operate, at least in principle, from as low a voltage as one desires to use. This is one of their important advantages and is one of the reasons that such motors have been given considerable attention in recent years. Furthermore, as already indicated, capacitor motors can operate not only from dc sources, but also from ac

sources. Finally, when powered by an ac source, they can operate both as synchronous and asynchronous motors (Zipernowsky's original motor operated from ac as an asynchronous motor).

A synchronous capacitor-type electrostatic motor is merely a multi-electrode capacitor motor without a commutator, the proper charging of the rotor being accomplished by continuously supplying an ac voltage of proper frequency between the stator and the rotor (Fig. 38). It is easy to see that if the rotor moves by one electrode in one period of the supply voltage, then the ac voltage accomplishes the same effect as that accomplished by a dc voltage with a commutator. The synchronous velocity is therefore $2\pi f/N$, where f is the frequency of the supply voltage and N is the number of the electrodes.

Several precision-made synchronous motors were described in 1969 by B. Bollée.⁵ One of these motors ran on sapphire bearings and had a cylindrical aluminum rotor 1 centimeter long and 0.45 centimeters in diameter; the rotor and the stator had 60 electrodes each, with a 0.001 centimeter gap between stator and rotor electrodes. The maximum power of this motor was about 100 microwatts at 220 volts and 50 hertz. Another motor (for an electric clock) had a dielectric disk rotor, with four rows of 100 electrodes on each side, located between two bearing covers, each with five rows of 100 elec-

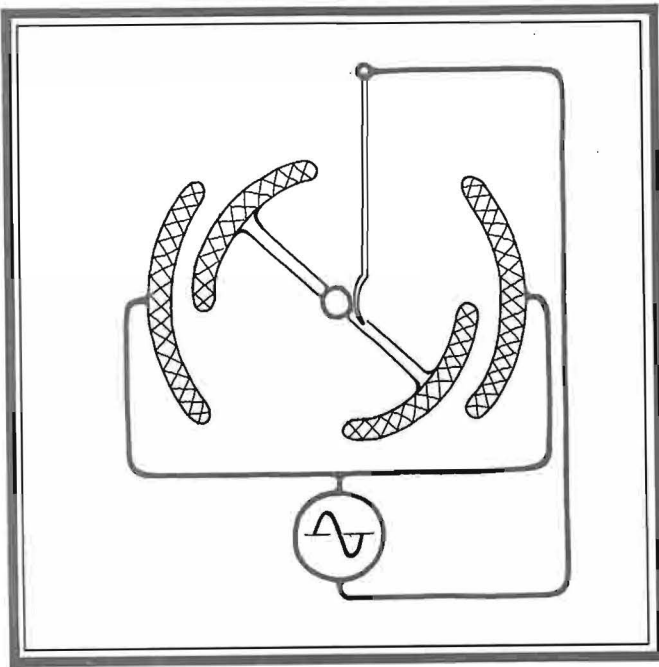

FIGURE 38

In a synchronous capacitor-type electrostatic motor the proper charging of the rotor is accomplished by continuously supplying an ac voltage of proper frequency between the stator and the rotor.

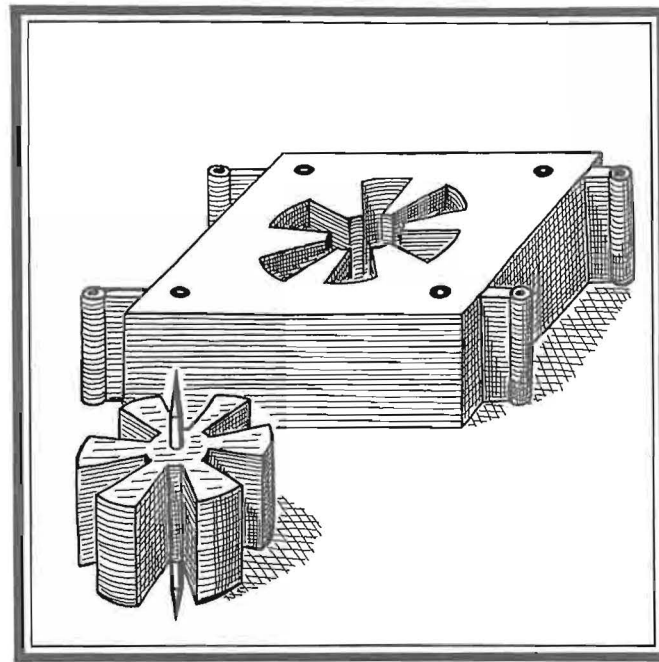

FIGURE 39

This synchronous electrostatic motor is essentially a variable capacitor with a rotatable shaft. The design of this motor is similar to the design of an electrostatic variable-capacitance generator.

trodes; the gap width in the axial direction was 0.01 centimeter. At 200 volts this motor had a maximum output of 600 microwatts. An interesting feature of this motor was that it had no slip ring on the rotor shaft, and that the rotor was therefore not connected to the power source. Instead, the stator was divided into two mutually insulated halves. This arrangement reduced the friction of the rotor and improved the performance of the motor. Still another motor was essentially a variable capacitor with a rotatable shaft. It had 15 plates in the stator and 14 in the rotor, each 0.03 centimeters thick; the gaps between stator and rotor plates were 0.015 centimeters (Fig. 39). The design of this motor is similar to the design of the electrostatic variable-capacitance generator described by N. J. Felici.⁶

According to Bollée, the maximum average torque on the rotor in a capacitor-type electrostatic motor is $T_{\max} = kNV^2$, where k is a geometrical constant, and V is the peak voltage applied. A motor with many electrodes is therefore slow but produces greater torque. The power of the motor is proportional to the square of the applied voltage and to the frequency but does not depend on the number of electrodes.

An important parameter in capacitor-type electrostatic motors is the capacitance difference $C_{\max} - C_{\min}$, where C_{\max} is the greatest capacitance between the rotor and the stator and C_{\min} is the smallest capacitance as they oc-

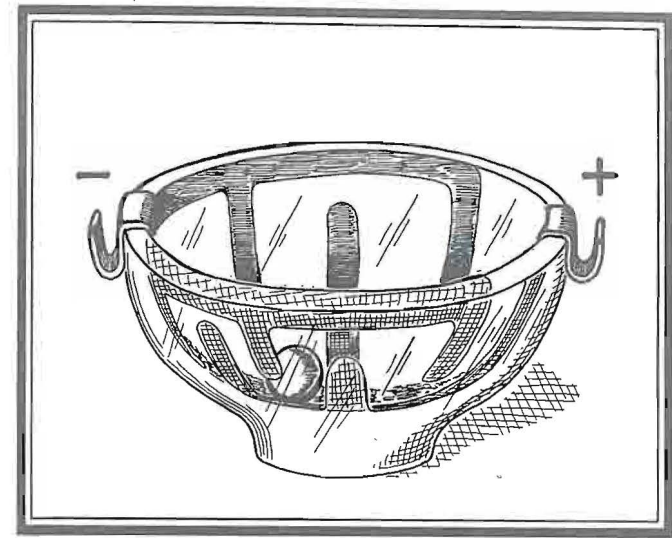

FIGURE 40

This interesting motor has been described by Moore, who calls it the "Interdigital Motor". The stator consists of a glass bowl with strips of aluminum foil glued to it. The rotor is a single conducting ball inside the bowl.

cur when the rotor turns. The larger this parameter is, the better are both the torque and the power. The main objective in the design of such motors is therefore to obtain the greatest possible variation of the capacitance.

An interesting motor which can be classified either as a modified Franklin's second motor or as a modified capacitor-type motor has been described by Moore,⁷ who calls it the Interdigital Motor. The stator consists of a glass bowl with strips of aluminum foil glued to it (Fig. 40). The rotor is a single conducting ball inside the bowl; the ball runs along the sloping side when the strips are connected to an electrostatic generator (positive and negative strips are connected in alternation). Several balls can be placed into the bowl at the same time, and all of them will then run.

REFERENCES

1. "Zipernowsky Electrostatic Motor", *Electrical World*, Vol. 14, p. 260 (1889).
2. W. Thomson, *British Association Report*, 1855 (2), p. 22.
3. N. G. van Huffel, *Zeitschrift für den Physikalischen und Chemischen Unterricht*, Vol. 17, pp. 316-317 (1904).
4. W. Thomson, *British Association Report*, 1867, pp. 489-513.
5. B. Bollée, *Philips Technical Review*, Vol. 30, pp. 178-194 (1969).

6. N. J. Felici, *Electronics and Power*, Vol. 11, pp. 169-171 (1965).
7. A. D. Moore, *Electrostatics*, Doubleday and Company, Inc., New York, 1968, p. 109.



INDUCTION MOTORS

In 1892-1893, electrostatic motors of a fundamentally new kind were described by Riccardo Arno^{1,2} and by W. Weiler.³ Their motors operated on the principle that the polarization of a dielectric in a variable electric field lags behind the field inducing the polarization. Therefore if a dielectric body is placed into a rotating electric field, the polarization charges* induced on the body will experience a force causing the body to follow the rotation of the field.

Arno's motor (Fig. 41) had a cylindrical stator formed by four insulated copper segments enclosing the space in which the rotating field was to be produced. The rotor was a hollow closed ebonite cylinder supported on two steel

*See, for example, O. Jefimenko "Electricity and Magnetism", Appleton-Century-Crofts, Inc. (1966), pp. 245-249.

points turning in holes in glass; the cylinder weighed 40.33 grams, was 18 centimeters long and 8 centimeters in diameter. The rotating field was produced by means of a high-voltage transformer (3800 volts output), an RC-circuit, and a mercury commutator. The rotor attained a speed of about 250 rpm and developed a torque of $176 \text{ centimeter}^2 \times \text{gram} \times \text{second}^{-2}$.

Weiler used a hand-operated double commutator for his motors. The commutator delivered high voltage from an electrostatic generator in sequence to the four segments of a stator, thus producing the needed rotating electric field. Weiler described four different motors utilizing rotating fields. One of his motors was similar to Arno's motor. The operation of this motor (and that of Arno's motor) can be explained with the aid of Fig. 42, representing the top view of the motor. When segment A of the stator is positive, and segment B is negative, the electric field of the stator induces in the dielectric rotor (assumed to be at rest) polarization charges as shown in the figure. After the commutator has completed $\frac{1}{4}$ revolution, segment C is positive and segment D is negative. Thus the field has rotated by 90° , and now it polarizes the rotor in a new direction (at 90° with respect to the first). However, since it takes a certain time for the polarization charges to relax to zero, some of the initial polarization charges are still on the rotor, so that the distribution of the polarization charges on the rotor is not symmetrical relative

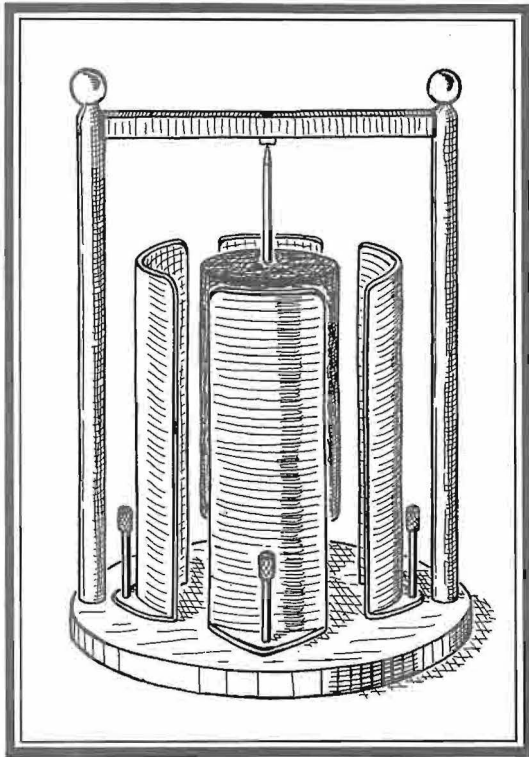

FIGURE 41

Arno's induction motor operated on the principle that the polarization of a dielectric in a variable electric field lags behind the field.

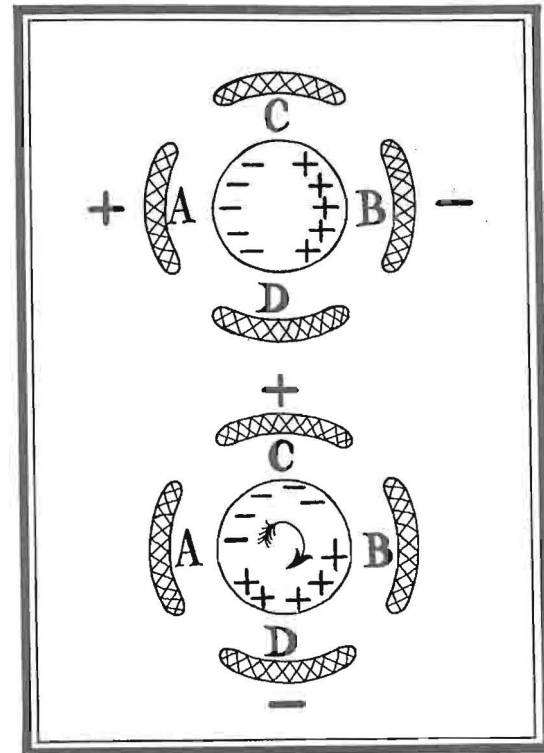

FIGURE 42

The operation of Arno's and Weiler's induction motors can be explained with the aid of this diagram.

to the charges on the stator. The rotor experiences therefore a torque due to attraction and repulsion between the rotor charges and stator charges, and the rotor turns.

Weiler also experimented with motors having noncylindrical rotors. One such motor is shown in Fig. 43. Rotating field electrostatic motors with disk-shaped rotors were built and studied between 1894 and 1901 in Japan by Hiderato Ho.⁴

Since Arno's and Weilers motors depend for their operation on induced polarization charges, they may be called "induction motors".

Induction motors, too, have a number of appealing features which attracted considerable interest to such motors in recent years: the motors can operate from both dc and ac; the motors can operate from low-voltage sources; since the motors require no brushes or slip rings, friction losses in these motors are very small.

Several carefully designed induction motors (both cylindrical and flat) were described in 1969 by Bollée.⁵ One such motor of cylindrical geometry operated from a three-phase power supply at 220 volts and 50 hertz. The stator had 12 electrodes, which surrounded a rotor 15 centimeters in diameter. A disk-type induction motor operating from a three-phase power supply had a rotor consisting of 10 glass disks, each 6 centimeters in diameter, coated with a thin layer of slightly conductive material and mounted on a common axle. The rotor turned inside a ring

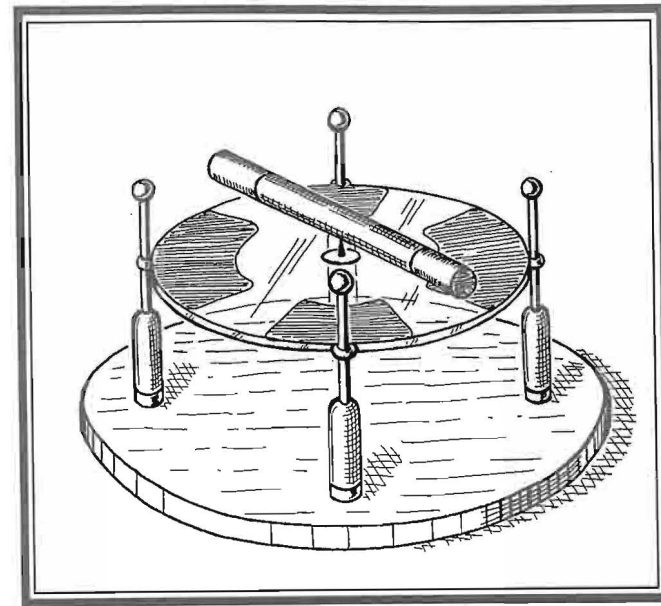

FIGURE 43

In 1892-1893, Weiler also experimented with induction motors having noncylindrical rotors, such as the motor shown in this drawing. Induction motors have a number of appealing features which attracted considerable interest to such motors in recent years.

formed by 60 comb-shaped stator electrodes. The maximum torque was $2000 \text{ centimeter}^2 \times \text{gram} \times \text{second}^{-2}$ at 220 volts and 50 hertz.

Another interesting motor described by Bollée was a linear induction motor, which "may be regarded as a segment of rotating-field motor bent straight".⁵

An extensive mathematical analysis of the induction motors was published in 1970 by Soon Dal Choi and D. A. Dunn.⁶ They tested their theoretical results on a cylindrical motor with 72 electrodes. The motor was 14 inches wide, 14 inches high, and $19\frac{1}{4}$ inches long. It had a Plexiglas rotor that turned at a maximum rate of about 1000 rpm when powered by a 10-kilovolt source.

REFERENCES

1. R. Arno, *Rediconti della Atti Reale Accademia dei Lincei*, Vol. 1 (2), p. 284 (1892).
2. R. Arno, *The Electrician*, Vol. 29, pp. 516-518 (1892).
3. W. Weiler, *Zeitschrift für den Physikalischen und Chemischen Unterricht*, Vol. 7, pp. 1-4 (1893).
4. "A Rotary Field Electrostatic Induction Motor", *Electrical World*, Vol. 37, pp. 1012-1014 (1901).
5. B. Bollee, *Philips Technical Review*, Vol. 30, pp. 178-194 (1969).
6. S. D. Choi and D. A. Dunn, *Proceedings of the IDEE*, Vol. 59, pp. 737-738 (1971).



LIQUID-IMMERSED MOTORS

In 1893, W. Weiler discovered that a glass cylinder placed in a poorly conducting liquid between two spherical electrodes began to rotate when the electrodes were connected to an electrostatic generator.¹ He then constructed a small motor based on this discovery (Fig. 44). The principle of the operation of this motor was essentially the same as that of a cylindrical corona motor, except that the charges were now deposited on the rotor not by a corona discharge, but by the conduction current in the liquid.

In 1896, G. Quincke reported the same phenomenon and published a very comprehensive experimental study of it.² His device is shown in a simplified form in Fig. 45. It is interesting to note that Quincke, rather than Weiler, has been credited by subsequent investigators with the discovery of the rotation of dielectric bodies in

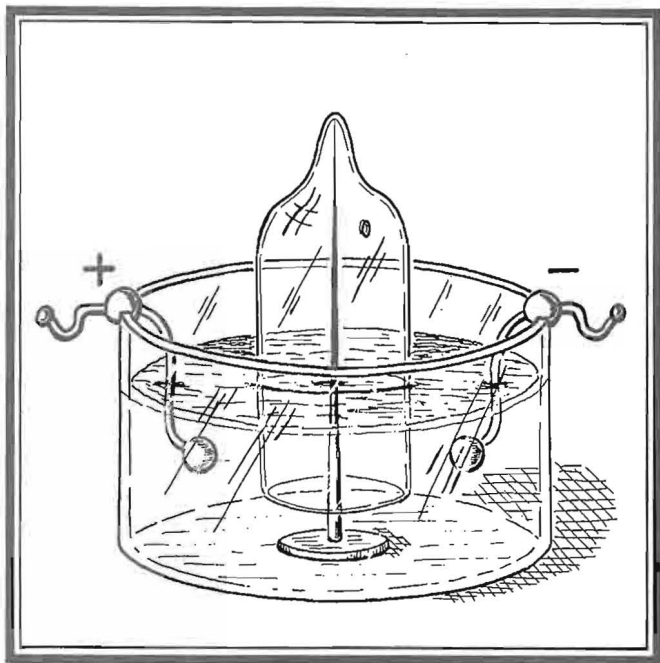

FIGURE 44

In 1893, W. Weiler discovered that a glass cylinder placed in poorly conducting liquid between two spherical electrodes began to rotate when the electrodes were connected to an electrostatic generator.

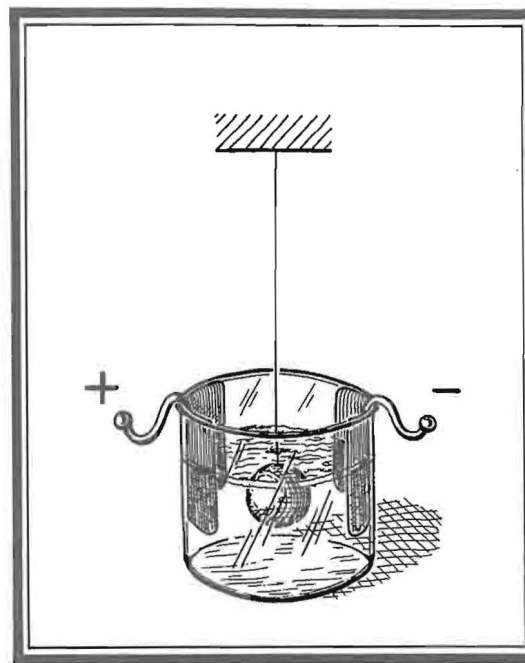

FIGURE 45

In 1896, G. Quincke reported the same phenomenon of rotation and published a very comprehensive experimental study of it. His liquid-immersed motor is shown in a simplified form in the above drawing.

poorly conducting liquids.

Weiler-type liquid-immersed dielectric motors were recently studied in considerable detail by P. E. Secker and his co-workers.^{3,4} Their motors operated in various semi-insulating liquids such as hexane, hexane doped with amyl alcohol or ethyl alcohol, and isoamyl alcohol.

In one of their motors the electrodes were stainless steel squares 1.8 centimeters on a side. Their separation was varied from 1 to 2.5 centimeters. The rotor, of ebonite or Perspex, was 0.95 centimeters in diameter and 2.2 centimeters long. The operating voltage was from 3 to 30 kilovolts. The speed of the motor was found to be a linear function of the applied voltage, with the maximum recorded speed of about 2500 rpm.

In another motor, a stator with six electrodes was used (Fig. 46). The rotor was made of Perspex and was 7/8 inches in diameter and 2 inches long; it had a layer of high-permittivity material on its surface (titanium ceramic in polystyrene). Powered by a 30-kilovolt source, the motor turned at 1700 rpm, and the total power input amounted to 5.4 watts, of which 2.7 watts appeared at the rotor shaft.

A discussion of electrohydrodynamic effects that may take place during an operation of liquid-immersed motors has been presented by J. R. Melcher and G. I. Taylor.⁵

Because of considerable hydrodynamical losses, the motors of this type will apparently always have a relatively low output torque.

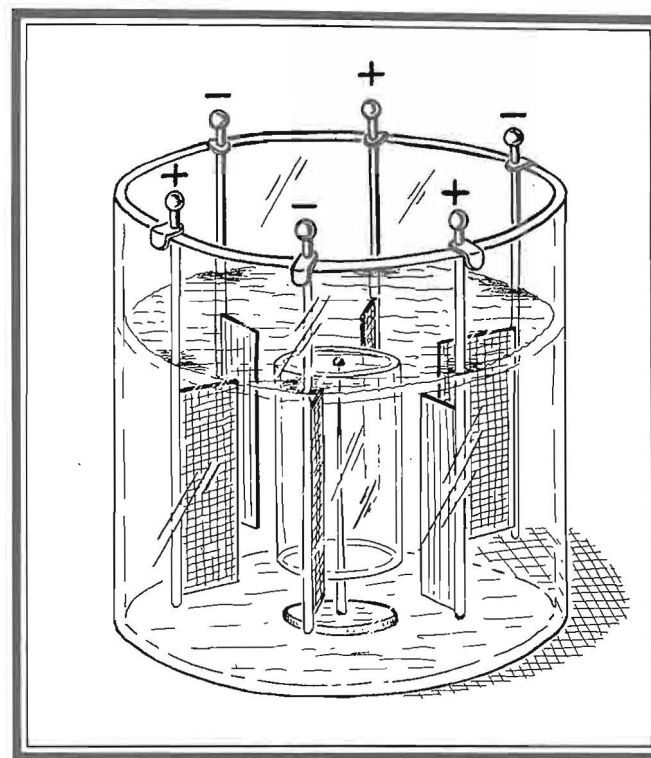

FIGURE 46

This liquid-immersed dielectric motor was recently studied in considerable detail by P. E. Secker and his co-workers.

REFERENCES

1. W. Weiler, *Zeitschrift für den Physikalischen und Chemischen Unterricht*, Vol. 6, pp. 194-195 (1893).
2. G. Quincke, *Annalen der Physik*, Ser. 3, Vol. 59, pp. 417-486 (1896).
3. P. E. Secker and I. N. Scialom, *Journal of Applied Physics*, Vol. 39, pp. 2957-2961 (1968).
4. P. E. Secker and M. R. Belmont, *Journal of Physics D: Applied Physics*, Vol. 3, pp. 216-220 (1970).
5. J. R. Melcher and G. I. Taylor, *Annual Review of Fluid Mechanics*, Vol. 1, pp. 111-146 (1969).



ELECTRET MOTORS

In general, an electret is a permanently charged dielectric body. In a more restricted sense of the word, an electret is a permanently polarized dielectric body and may be considered to constitute the electrical counterpart of a permanent magnet. It is this latter type of electret that has been used for constructing electrostatic motors.

In 1961, the Russian physicist A. N. Gubkin described an electret motor¹ shown schematically in Fig. 47. The motor consisted of a stator formed by two horizontal, axially symmetric, parallel-plate capacitors and a rotor formed by two flat, axially symmetric, oppositely polarized electrets mounted on a vertical axle and capable of passing between the plates of the capacitors. The motor operated as follows. When a voltage was applied to the two capacitors, so that

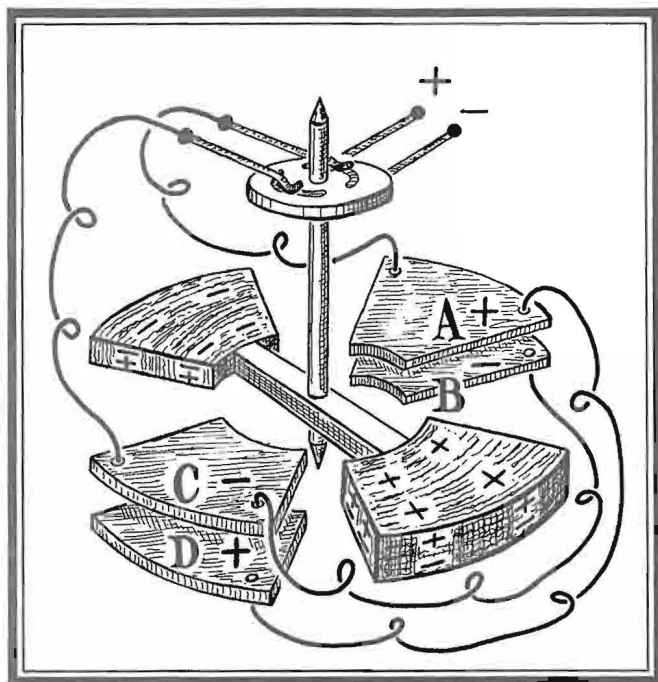

FIGURE 47

In 1961, the Russian physicist A. N. Gubkin described this motor with two electrets in the rotor and two parallel-plate capacitors in the stator. A commutator was used to change the polarity of the capacitors.

plates A and D were positive and plates B and C were negative, the capacitors attracted the electrets as soon as the latter came close to the plates, and the electrets were pulled into the capacitors. A commutator changed the polarity of the plates just as the electrets were coming out from the capacitors, and the electrets were then repelled from them, and so on. Thus the rotor was set in a continuous rotation.

A well-known property of electrets is that they lose their polarization in the absence of adequate shielding. Electret motors with almost perfect shielding were described by this author and by D. K. Walker in 1970.² These motors were based on the so-called "electret slot effect".³ The slot effect works as follows (Fig. 48). An electret is placed between two pairs of electrodes, each pair forming a slot. If a voltage is applied to one or both electrode pairs, the electret (or the electrodes) experiences a force in a direction perpendicular to the slot and parallel to the plates. This arrangement insures both a nearly perfect shielding and a relatively large force.

A simple electret motor utilizing the slot effect is shown in Fig. 49 and Plate 5.* It uses a disk-shaped carnauba wax electret rotor consisting of two oppositely polarized half-disks. The stator has two pairs of electrodes connected to a

*The motor was designed by the author and built by one of his students, Charles Lynn Walls, in 1966.

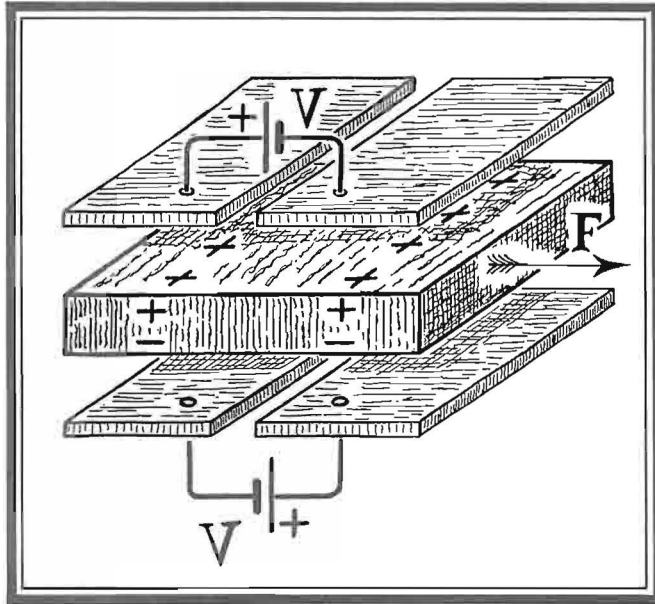

FIGURE 48

The slot effect works as follows. An electret is placed between two pairs of electrodes, each pair forming a slot. If a voltage is applied to one or both electrode pairs, the electret experiences a force in a direction perpendicular to the slot and parallel to the plates.

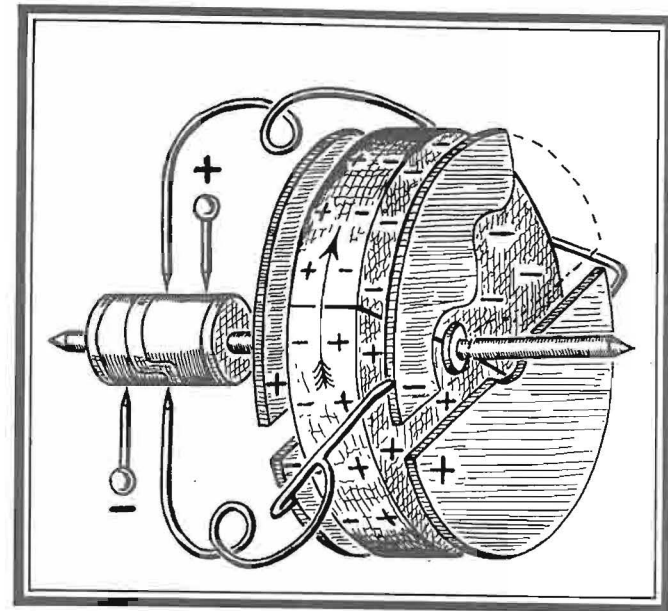

FIGURE 49

This simple electret motor utilizes the slot effect. The rotor is made of a disk-shaped electret consisting of two oppositely polarized half-disks. The stator has two pairs of slotted electrodes connected to a cylindrical commutator, which is charged by contact or by sparks.

cylindrical commutator. The thickness of the rotor is $\frac{1}{2}$ inch, the diameter is 5 inches. The motor operates from an 8-kilovolt power supply and rotates at 1500 rpm.

Similar motors with stationary electrets and rotating electrodes are shown in Plates 6 and 7.

A more sophisticated slot-effect motor² uses a cylindrical electret (Fig. 50 and Plate 8). The electret is stationary; it is shaped as a hollow cylinder and has four sections of opposite radial polarization. The rotor is made of four internal and four external aluminum electrodes forming two cylinders with four slots in each. The inner electrodes are cross-connected with the outer ones, and all electrodes are supported by a Plexiglas disk mounted on a steel axle. This motor uses no commutator. The power is delivered to two adjacent external electrodes by means of two sharp points which charge the rotor through a corona discharge. The overall diameter of this motor is 3 inches, the operating voltage is 6 kilovolts, the speed is up to 5000 rpm, the power is about 20 milliwatts.

Synchronous electret motors for electric clocks have been recently announced by the General Time Corporation. The motors are about $1\frac{1}{4}$ inches in diameter and $\frac{1}{4}$ inch thick. In these motors (Fig. 51) a thin plastic electret disk with 15 active sectors and 15 equally large cut-outs is the rotor. The rotor is placed between two stator plates fabricated as printed circuit boards. Each stator plate has 30 elec-

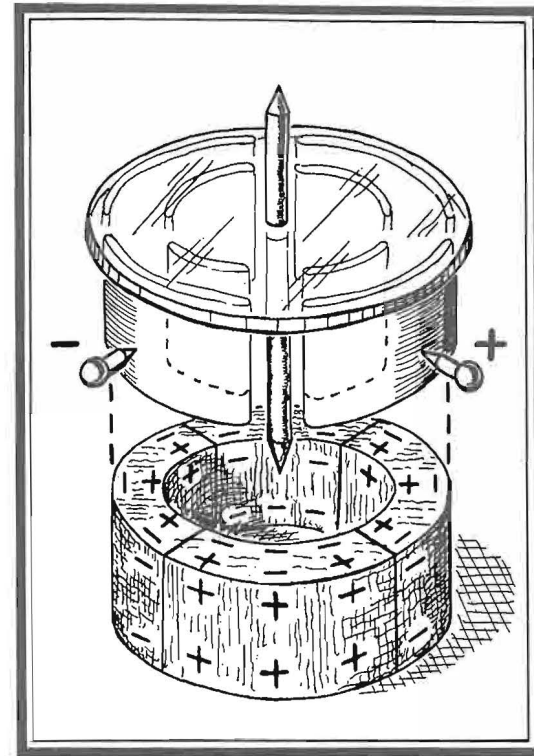

FIGURE 50

This more advanced slot-effect motor uses a stationary cylindrical electret and works without a commutator. The rotor has 8 slots.

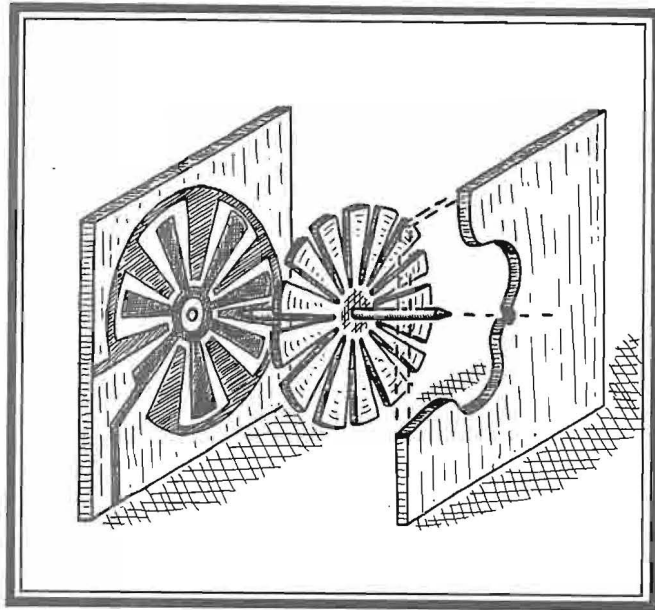

FIGURE 51

In this simplified version of a synchronous electret motor for electric clocks a thin plastic electret disk with several active sectors and several cut-outs is used as the rotor.

trodes connected in alternation to the two input terminals. The operation of this motor is similar to that of the first slot-effect motor described above (Fig. 49) except that the reversal of polarity of the electrodes is accomplished directly by the applied ac voltage rather than by a commutator.

Of all presently known types of electrostatic motors, electret motors are the newest and (together with corona motors) the most highly promising ones. We shall return to them once again in the next chapter.

REFERENCES

1. A. N. Gubkin, *Electrets*, Academy of Sciences, Moscow, 1961, pp. 130-133 (in Russian).
2. O. Jefimenko and D. K. Walker, *Conference on Dielectric Materials, Measurements and Applications*, The Institution of Electrical Engineers, London, 1970, pp. 146-149.
3. O. Jefimenko, *Proceedings of the West Virginia Academy of Sciences*, Vol. 40, pp. 345-348 (1968).

10

WHAT TO EXPECT FROM ELECTROSTATIC MOTORS

Having described the various types of electrostatic motors we shall now present a brief discussion of the current aims in the electrostatic motor research and a brief discussion of the most probable future uses and applications of these motors.

It has been pointed out by Bollée¹ that electromagnetic motors rapidly lose their efficiency in scaled-down versions (which is due to the relative increase in energy dissipation in the magnet coils) and that very small capacitor-type and induction-type electrostatic motors may be a better choice for miniaturized systems. Therefore one may expect that miniature electrostatic motors of these types will find applications in various sensor and control devices where only very small torques and power are needed.

Experiments with electret motors conducted

in the author's laboratory² indicate that these motors may be very useful in systems where powers of up to 1 watt are needed.

The most promising electrostatic motors appear to be, however, the corona motors. These motors possess a number of highly desirable features. Here are some of them: the motors are extremely simple in design; they require no expensive materials; their maintenance is very simple; having only few metal parts they possess a very good power-to-weight ratio; they are fully capable of developing appreciable amounts of power; and they can attain very high speeds.

Our present-day awareness of the many attractive properties of corona motors is to a great extent due to the work of the Russian engineers Yu. Karpov, V. Krasnoperov, and Yu. Okunev published in 1958 and 1960.^{3,4} They described a 6-watt cylindrical corona motor of improved design (Fig. 52) operating from a 7-kilovolt power supply and turning at a rate of 6000 rpm. This motor had a hollow Plexiglas rotor 10.5 centimeters in diameter and 17 centimeters long with a conducting lining on its inner surface. The stator supported 16 knife-like electrodes inclined relative to the surface of the rotor in the direction of the desired rotation. The lining of the rotor served to increase the electric field in the gap between the electrodes and the surface of the rotor and thus to enhance the corona discharge from the electrodes.

A high-speed corona motor with a disk rotor

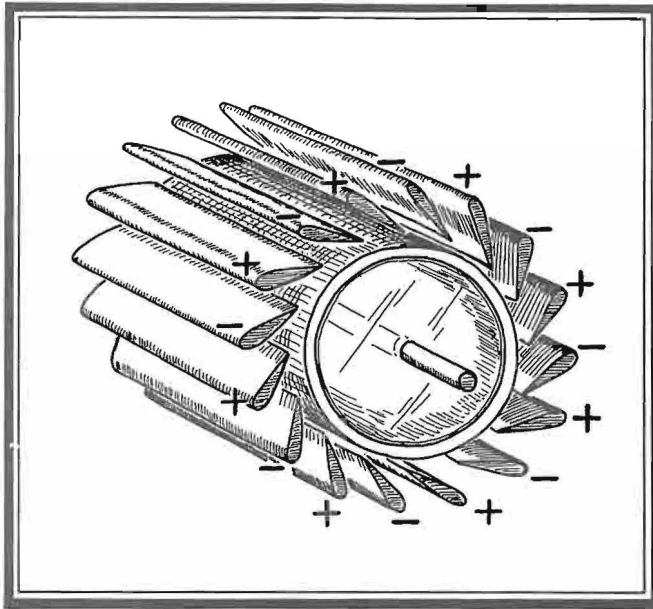

FIGURE 52

In 1958, the Russian engineers Yu. Karpov, V. Krasnoperov, and Yu. Okunev described a 6-watt cylindrical corona motor of an improved design operating from a 7-kilovolt power supply and turning at a rate of 6000 rpm. This motor had a Plexiglas rotor.

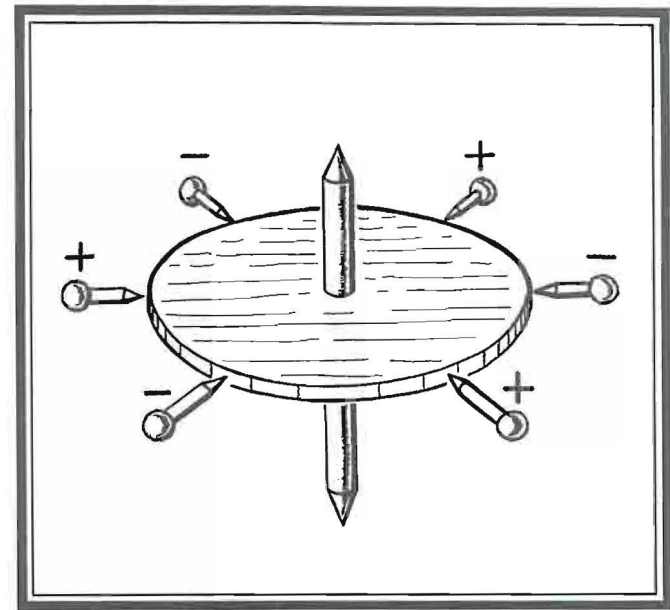

FIGURE 53

This corona motor with a disk rotor and circumferential electrodes was described by J. D. N. Van Wyck and G. J. Kühn of South Africa in 1961. It had a rotor 1.5 inches in diameter turning in jewel bearings. Operating from 13 kilovolts, the motor ran at 12000 rpm.

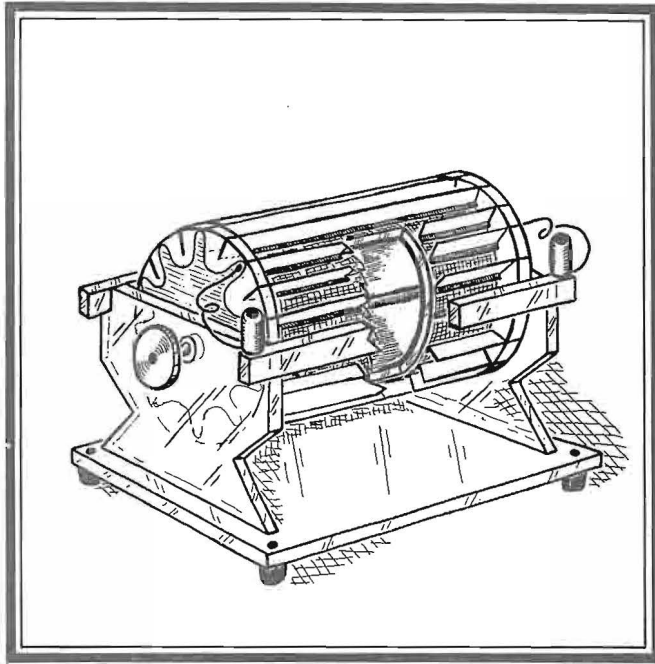

FIGURE 54

The performance of a corona motor depends on the shape and arrangement of electrodes and the structure of the rotor. The curved electrodes of this motor produce an especially large torque. The lining of the rotor increases the power.

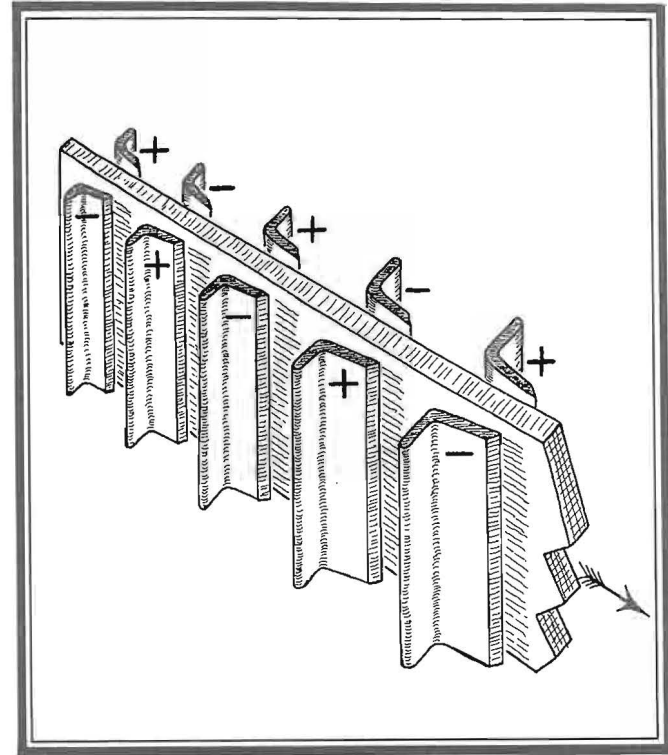

FIGURE 55

The mechanism of electric interaction producing rotational motion in corona motors can be used to achieve a translational motion as well. This drawing shows the principle of a linear corona motor with multiple electrodes.

and circumferential electrodes was described by J. D. N. Van Wyck and G. J. Kühn of South Africa in 1961.⁵ The motor (Fig. 53) had a rotor 1.5 inches in diameter turning in jewel bearings. The stator supported 6 sharp-point electrodes. Operating from 8-13 kilovolts, the motor developed speeds of up to 12000 rpm.

A similar motor was studied in Poland by B. Sujak and W. Heffner in 1963.⁶

A number of advanced corona motors were studied in the author's laboratory;⁷ an example of these motors is given in Fig. 54 and Plate 9. A diagram of a linear corona motor designed by the author is shown in Fig. 55. Instructions for building the corona motors of the author's design may be found in the May 1971 issue of Popular Science.⁸

It appears that corona motors with input power of 100 to 1000 watts and efficiency of at least 60% can be constructed without any difficulty. There seems to be no reason why even more powerful corona motors could not be built. It is likely that the motors can be further improved by using rotors immersed in a gas other than the air at atmospheric pressure.

Performance characteristics of corona motors strongly depend on the design and geometrical configuration of the electrodes spraying charges onto the rotor. Several typical electrode types and electrode configurations for corona motors are shown in Fig. 56. Especially interesting is the electrode arrangement shown in Fig. 56c.

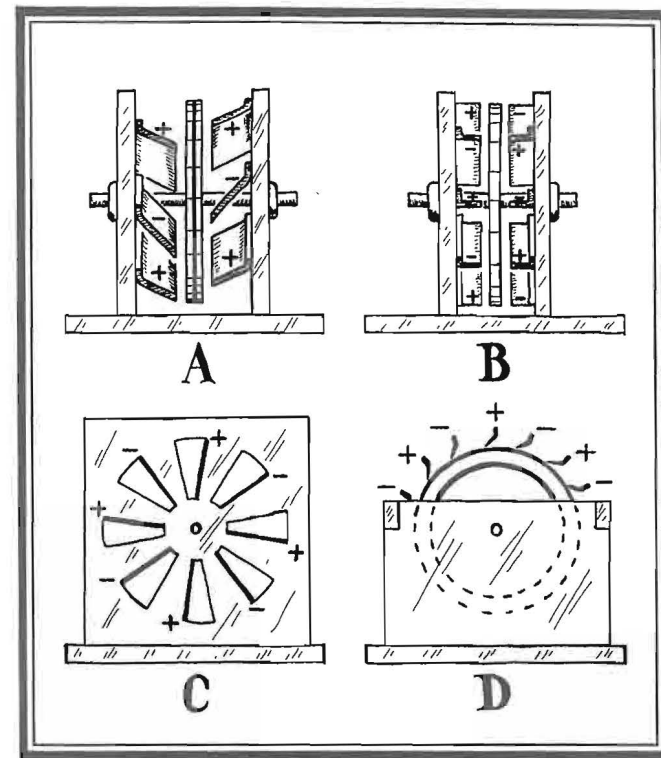

FIGURE 56

(a) Slanted electrodes and disk rotor with a conducting lining in the middle; (b) Straight electrodes; (c) Foil electrodes shielded on one side; (d) Curved electrodes and cylindrical rotor with a conducting lining.

This arrangement is used in conjunction with thin disk-shaped rotors "sandwiched" between two insulating stator plates. An even number of windows is cut in each stator plate, and metal foil electrodes are glued to the walls of the holes, as shown by heavy lines in Fig. 56c. In this arrangement there is a dielectric medium on one side of each electrode, and there is air on the other side. Therefore the electrodes spray charges predominantly in the direction of the side facing the air. Thus a motor with electrodes of this type is unidirectional and self-starting. Furthermore, the entire "sandwich" comprising the rotor and the two stator plates may be very thin. Therefore many such "sandwiches" can be placed on a single axle thus forming a compound motor in which good use is made of the entire volume occupied by the motor. There are indications that compound motors of this type can develop up to 1000 horsepower for each cubic meter of their volume.

An important property of electrostatic motors is that they can operate from a much greater variety of sources than the electromagnetic motors. It is, of course, obvious that any sources used for operating conventional electromagnetic motors can be used to operate the electrostatic motors. However, the electrostatic motors can operate also from sources from which no other motors can operate. The reason for this is that the electrostatic motors are extra-high impedance devices and thus require extremely

small currents for their operation.

One very interesting source of electricity for electrostatic motors is the ordinary capacitor. It is true that capacitors, as we know them now, do not store appreciable amounts of electric energy. However, if high-permittivity low-loss dielectric materials were developed, then the capacitor would become a very useful device for storage of electric energy, and possibly could be used in place of the chemical batteries for operating electrostatic motors.

Another possible source of power for electrostatic motors are high-impedance high-voltage batteries of the type of Zamboni pile.

A potentially very important source of electricity for powering electrostatic motors are electrostatic generators. Considerable advances in the development of such generators have been made in recent years^{9,10} and it is conceivable that electrostatic motor-generators will be used to convert the high-voltage dc produced by such generators into the conventional low-voltage dc or ac.

Finally, a very interesting source for powering electrostatic motors is the atmospheric electric field. In fact, it appears possible to extract the energy contained in this field by means of electrostatic motors. Experiments on such an energy extraction have been conducted by the author.^{11,12} In these experiments an electret motor and a corona motor were powered by simple earth-field antennas (Fig. 57; Plates 10 to

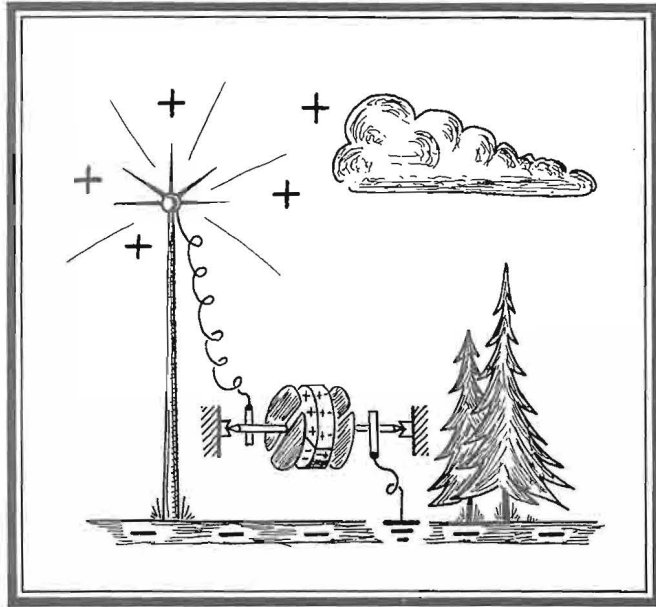

FIGURE 57

Small electrostatic motors can be powered from atmospheric electricity by means of simple earth-field antennas. Whether or not it will be possible to operate large motors in this manner will depend on how successful we are in designing antennas capable of extracting appreciable power from the earth electric field.

12). The corona motor was the one shown in Plate 9. The electret motor was similar to that shown in Fig. 49, but with the electret stationary and the electrodes rotating (Plate 6). These experiments indicate that it is entirely possible to operate small electrostatic motors from atmospheric electricity. Whether or not it will be possible to operate large motors in this manner will depend on how successful we will be in designing and building earth-field antennas capable of extracting appreciable power from the earth electric field.

In conclusion it may be useful to mention that a quantitative electrostatic motor research is now only in its very rudimentary stage. Almost all papers on electrostatic motors published thus far deal with the qualitative aspects of the performance of the various types of motors. Only very few papers deal with the optimization of design and with the quantitative aspects of the operation of the motors, likewise only very few papers present a theoretical analysis of the electrostatic motors. It is clear therefore that the electrostatic motors still constitute an essentially unexplored area of physics and engineering, and that the electrostatic motor research is presently one of the potentially most rewarding research fields in modern electrostatics.

REFERENCES

1. B. Bollée, *Philips Technical Review*, Vol. 30, pp. 178-194 (1969).

2. O. Jefimenko and D. K. Walker, *Conference on Dielectric Materials, Measurements and Applications*, the Institution of Electrical Engineers, London, 1970, pp. 146-149.
3. Yu. Karpov, V. Krasnoperov, and Yu. Okunev, *Tekhnika Molodezhi*, Vol. 26, pp. 36-37 (Sept. 1958) (in Russian).
4. Yu. Karpov, V. Krasnoperov, Yu. T. Okunev, and V. V. Pasynkov, "On the Motion of Dielectrics in an Electric Field", in *Dielectric Physics*, Academy of Sciences, Moscow, 1960, pp. 124-131 (in Russian).
5. J. D. N. Van Wyck and G. J. Kühn, *Nature*, Vol. 192, pp. 640-650 (1961).
6. B. Sujak and W. Heffner, *Acta Physica Polonica*, Vol. 23, pp. 715-726 (1963).
7. O. Jefimenko and H. Fischbach-Nazario, *Proceedings of the West Virginia Academy of Sciences*, Vol. 42, pp. 216-221 (1971).
8. C. P. Gilmore and W. J. Hawkins, *Popular Science Monthly*, Vol. 198, pp. 95-97, 114 (May 1971).
9. N. J. Felici, *Elektrostatische Hochspannungs-Generatoren*, G. Braun, Karlsruhe, 1957.
10. J. Hughes and P. Secker, *New Scientist and Science Journal*, Vol. 49, pp. 468-470 (1971).
11. O. Jefimenko, *American Journal of Physics*, Vol. 39, pp. 776-778 (1971).
12. W. Aston, *West Virginia University Magazine*, Vol. 3, Number 4, Spring 1971, pp. 6-11.

INDEX

INDEX

- Adams, G., 37
 Aimé, R., 29,38
 Arno, Q., 84,90
 Arno Motor, 84,85,87
 Aston, W., 118
 Asynchronous motors, 4, 77
 Atmospheric electricity, 3, 115-117
 Avery, F. M., 21
- Backing plate, 59, 107
 Behrens, G., 14
 Bell jar motor, 48, 49, 52
 Belmont, M. R., 96
 Benjamin, P., 21
 Bichat, E., 29, 32, 38
 Bollée, B., 77, 80, 82, 90, 106, 117
 Bollée capacitor motors, 77, 79, 80
 Bollée induction motors, 88, 90
- Capacitor motors, 4, 73-77, 80, 82, 106
 Chew, V. K., 37
 Choi, S. D., 90
 Christenson, A., 38
- Christiansen, C., 60, 71
 Christiansen motor, 60
 Classification of electrostatic motors, 4
 Collinson, P., 39
 Contact motors, 4, 6, 20
 Corona discharge, 22, 56, 71
 Corona-kraft levitation, 33
 Corona motors, 4, 56, 58, 60-66, 68-71, 107-112, 115, 116
- Dailey, H. B. and E. M., 15, 21
 Dailey motor, 15-18
 Davis, J. W., 63
 Draper, J. W., 55
 Dressel, R. H., 51, 55
 Dunn, D. A., 90
- Earth-field antennas, 115, 116, 117
 Electret, 97, 99
 Electret motors, 4, 97-104, 106, 114, 115
 Electret slot effect, 99, 100
 Electric bells, 6, 8-11, 23, 25
 Electric chimes, 11, 14, 23, 25
 Electric fly, 22-26, 29-31
 Electric horse-race, 26, 28, 29
- Electric motor, 1, 6, 39
 Electric orrery, 26, 27
 Electric pendulum, 6
 Electric pendulum motors, 6, 15, 16
 Electric perpetuum mobile, 3, 15, 16, 48, 50
 Electric pinwheel, 22
 Electric planetarium, 18, 19
 Electric rabbit hunt, 33, 36
 Electric racing ball, 18, 19
 Electric reaction wheel, 22
 Electric seesaw, 13, 14
 Electric swing, 12, 14
 Electric tellurium, 26, 27
 Electric tourbillion, 61, 63, 71
 Electric tourniquet, 29, 32
 Electric toys, 12, 13, 14, 28, 29, 33, 36
 Electric wheels, 37, 39
 Electric whirl, 22
 Electric wind, 23
 Electric wind motors, 22 ff, 33-35
 Electric wind turbines, 33, 35
 Electric wind wheels, 33, 34
 Electromagnetic motors, 1-3, 106, 114
 Electrophorus, 52
 Electrostatic forces, 1
 Electrostatic generators, 80, 115
 Electrostatic motors, 1-4, 106, 107, 114-117
- Farrington, J. B., 63
 Felici, N. J., 80, 83, 118
- Franklin, Benjamin, 7, 33, 37, 39, 42, 43
 Franklin bells, 7, 14
 Franklin first motor, 39-45, 48, 52
 Franklin motors, 39-45, 54, 57, 59
 Franklin second motor, 41, 43-45, 82
- Gale, L. D., 33, 38
 Gilmore, C. P., 72, 118
 Gordon, A., 6, 22
 Gordon bells, 6, 8, 15, 18, 20
 Gruel, W., 63
 Gruel motor, 61, 63
 Gubkin, A. N., 97, 105
 Gubkin motor, 97-99
 Guyot, M., 20, 21, 29, 33, 38, 55
- Hamilton, 23
 Hamilton electrometer, 23
 Hawkins, W. J., 72, 118
 Heffner, W., 112, 118
 Ho, H., 88
 Holtz, W., 56, 71
 Holtz rotation phenomenon, 56, 59, 60
 Van Huffer, N. G., 76, 82
 Van Huffer motor, 75, 76
 Hughes, J., 118
- Induction motors, 4, 84-90, 106
 Interdigital motor, 81, 82

- Jamin, M. J., 55
 Jefimenko, O., 54, 84, 105, 117, 118
 Johnson, R., 66
 Johnson motors, 64, 65, 66
- Kämpfer, D., 29, 38
 Karpov, Yu., 107, 108, 118
 King, W. R., 33
 Kinnersley, E., 26
 Krasnoperov, V., 107, 108, 118
 Kühn, G. J. 110, 118
- Langenbucher, J., 23, 29, 33, 37
 Langenbucher electrometer, 23, 24
 Levitation, electrostatic, 33
 Leyden jar, 6, 42, 43
 Linear corona motor, 111, 112
 Linear induction motor, 90
 Liquid-immersed motors, 4, 91-95
 Loeb, L. B., 38
- McVay, W., 66
 McVay motors, 66-71
 Magnetic forces, 1
 Mascart, M. E., 29, 38, 63, 72
 Mayes, T. L., 71
 Melcher, J. R., 94, 96
 Miller, D. C., 55
 Milliflpower motor, 48, 51
 Moller, S., 38
 Moore, A. D., 45-47, 55, 81-83
 Müller-Pouillet, 21
- Neuburger, A., 21, 33, 38
- Okunev, Yu., 107, 108, 118
 Oosting, H. J., 38
- Pendulum motors, 3, 6, 15, 16
 Perpetuum mobile, electric, 3, 15, 16, 48, 50
 Poggendorff, J. C., 37, 56, 59, 60, 71
 Poggendorff motor, 56-60, 66, 71
- Quincke, G., 91, 93, 96
- Reciprocating motor, 15, 17, 18
 Richmann, G. W., 7
 Rotating field motors, 84-90
 Ruhmkorff, 63
 Ruhmkorff motor, 62, 63
- Scialom, I. N., 96
 Secker, P. E., 94, 96, 118
 Secker motor, 94, 95
 Sivowitch, E. N., 18
 Slot effect, 99, 100
 Slot-effect motors, 99-103
 Spark motors, 4, 39-41, 46, 47, 49, 50, 53, 54
 Sparks, J., 21, 38, 54
 Sujak, B., 110, 118
 Synchronous motors, 4, 77, 102
 Syng, P., 33

- Taylor, G. I., 94, 96
 Thomson, W., 82
 Thomson electrometer, 73
 Thomson replenisher, 76
 Tomlinson, C., 29, 38
- Walker, D. K., 54, 99, 105
 Weiler, W., 84, 90, 91, 96
 Weiler induction motors, 87-89
- Weiler liquid-immersed motor, 91, 92
 Wilson, B., 37
 Wimshurst, J., 33
 Wommelsdorf, H., 55
 Van Wyck, J. D. N., 110, 118
- Zamboni, G., 14
 Zamboni pile, 3, 14, 15, 48, 115
 Zipernowsky, K., 73, 77
 Zipernowsky motor, 73, 74, 82

This book was set in Century Textbook.
The format was designed by the author.
The drawings were done by
Dr. D. K. Walker from the author's sketches.
The printer and binder was
Morgantown Printing & Binding Company.

Picture Credits

Plate 1: courtesy Smithsonian Institution, Washington, D.C.
Plates 2 and 3: courtesy Electret Scientific Company, Star
City, W. Va.
Plates 6, 9, 11, and 12: courtesy West Virginia University,
Morgantown, W. Va.
Plates 4, 5, 7, 8, and 10: author's photographs.