

## Chapter 19

### ASTRONOMY

"It certainly looks as though the lines of force either must go out to join the interstellar gas or they must join up at a distance far outside the Sun."

— Fred Hoyle

**T**he following is a very special tribute to Michael Faraday, whom I quote:

*"Here end my trials for the present. The results are negative; they do not shake my strong feelings of the existence of a relation between gravity and electricity, though they give no proof that it exist."*

[from *Michael Faraday* by L. Pearce Williams — originally from *Experimental Researches in Electricity*, paragraph (2717)]

Throughout the prior work I have presented, I have proven Faraday's brilliant insight correct. The following information further corroborates such insight.

**33. A.** I wish to thank Dr. Robert Smith (Chief, Orbital Space Environment Branch, Space Sciences Laboratory, NASA, Huntsville, Alabama) and Dr. Ellsworth Huntington (now deceased) whose work Dr. Smith forwarded to me. Dr. Smith is a thinking, questioning scientist who spoke in my behalf when others would not.

[Refer to Dr. Smith's letter of June 22, 1976.]

<sup>33</sup>

**B.** Dr. Smith discussed my work with others for several years. When Dr. Smith found that he was unable to encourage others to speak out regarding my work, he then wrote an even stronger letter in my behalf. [Refer to Dr. Smith's letter of March 20, 1979.] I hope the reader recognizes the scientific courage and intellectual honesty of Dr. Smith, since he had never seen a working Prototype of my Invention.

George C. Marshall Space Flight Center  
Marshall Space Flight Center, Alabama  
35812

33-A

Reply to Attn of: ES44

June 22, 1976

Mr. Joseph W. Newman  
1521 Deerwood Drive, East  
Mobile, AL 36618

Dear Joe:

I have read your article several times, believe that it is very worthwhile, and that it should be studied in much more detail.

I am sending you a Xerox copy of several pages of a book by Huntington that should be of great interest. It contains some of the data we discussed about inclinations of the various planets' orbits to the ecliptic. It also contains much information that supplements and complements your work. I have not read the entire book which can only (as far as I know) be obtained from the Library of Congress. If these pages are good examples, then the entire book would be of great value to you.

I intend to discuss your work with Dr. Willis Webb, an atmospheric scientist at the White Sands Missile Test Range, N. M., this week. He has a newly developed theory on the electrical structure of the earth. I intend to give him a copy of your paper and ask him to contact you.

I have thought about your smoke experiment in the jar and I believe that the particles that are suspended in the air are more than likely ionized and, therefore, should align themselves with the magnetic field lines. They probably stay ionized for long periods of time, because there are not enough other particles in the jar to make them lose their charge through collisions - the way they would if they were outside the jar.

In my opinion, the only way you can get the approval and widespread dissemination of your work that you want is through publication - preferably in a technical journal like the Journal of Geophysical Research, or the Journal of Atmospheric and Terrestrial Physics. I would highly recommend the former and advise you to spend the time and effort required to get it accepted for publication.

Endorsements by many individuals are not as valuable as getting your work published in a technical journal. While this can never measure the true worth of a person's research activities, at the present time it is used by members of the science community in that way.

I am going to continue to study your work and I will provide you with additional relevant data and information as I find it. Once again, I think you should continue to expand your efforts, as it appears as if the results could be very significant.

Please let me know if I can help you in any other way.

Sincerely,



Robert E. Smith  
Chief, Orbital & Space Environment Branch  
Aerospace Environment Division  
Space Sciences Laboratory

Enclosure:

"Earth & Sun"

*See Dr. Smith's letter  
of March 29, 1979.*

125 Westbury Drive  
 Huntsville, AL 35802  
 March 20, 1979

To Whom It May Concern:

Mr. Joseph W. Newman and I have been corresponding about his revolutionary concepts of magnetic fields for the past several years. I have not seen his experimental set-up but if his write-ups of the procedures and results are correct, then several laws of physics may need to be re-examined. If the manner in which Joe conducted his experiments and the results were made known to the industrial or engineering communities, then, in my opinion, several companies and/or individuals possess the expertise and capabilities to construct the hardware required to fully exploit the apparent capability of his new concepts.

*Robert E. Smith*

Robert E. Smith

*Dr. Smith is Chief of Space  
 Environment Branch  
 at NASA, Huntsville.*

C. Earlier in this Book, I have demonstrated the Unobvious electromagnetic (gyroscopic particle) effect of Matter and its "unequaling effect" which has been popularly termed "gravity." I have demonstrated the gyroscopic mechanical motion of electric charges and magnetic fields which attract and repel. I have demonstrated how electric current (consisting of gyroscopic particles) is released from electromagnetic fields. I have demonstrated that the negative and positive charges moving in an electromagnetic field are in reality a gyroscopic-type-particle traveling in different directions, comprising all Matter, and creating the effect of inertia in Matter. I have shown that the gyroscopic-action-particle is literally the mechanical essence of Einstein's equation of  $E = MC^2$ . I have also demonstrated to any individual with ade-

---

***"It is my Theory  
that a central electromagnetic field  
completely encompasses our Galaxy's  
electromagnetic field and causes our  
Galaxy to align with and orbit this central  
electromagnetic field."***

---

quate powers of reasoning that a new source of energy can be released from gyroscopic fields of force which are comprised of gyroscopic particles in motion. Considering these facts scientifically, one would surely conclude that the *entire* Universe is composed and controlled by these gyroscopic particles (electromagnetic energy).

Current astronomy books use words like "queer, odd, and peculiar" to describe many of the motions of planets and their satellites. Yet, such books provide no reason for these motions other than saying that "they just occur that way."

I will now explicitly apply the previous information presented in this Book to our Solar System, as well as the Universe, and I will demonstrate by using the laws of Magnetic and Electrical Forces that there is a particular reason for *all* astronomical motions.

The following information must all be Mastered, since its mechanical essence is applicable to space travel, food production, and the future safety of life as we know it on planet Earth.

<sup>33</sup>  
D. It is my Theory that a *central electromagnetic field* completely encompasses our Galaxy's electromagnetic field and causes our Galaxy to align with and orbit this central electromagnetic field. Our Galaxy's electromagnetic field causes the Sun to align with and orbit within our Galaxy since this electromagnetic field encompasses the Sun's own electromagnetic field. In turn, the Sun causes all the planets within our Solar System to align with and orbit the Sun because the Sun's electromagnetic field encompasses all of its planets and their respective electro-

magnetic fields. Such planetary, electromagnetic fields include the Earth's electromagnetic field which causes the Moon to align with and orbit the Earth since the Earth's electromagnetic field encompasses the Moon's electromagnetic field as do the other planets' fields encompass their respective moons. In essence, *everything in the Universe* moves in alignment with the gyroscopic-action-entity composition of respective electromagnetic fields. The observed interaction of these unobserved electromagnetic fields in space is called "gravity." In reality, gravity is the "unequaling effect" of the gyroscopic-action-entity composition of all Matter.

<sup>33</sup>  
E. In 1967 I wrote a 25-page document and sent it to the physics and astronomy departments of fifty-six major universities in the United States. [These universities are listed in a later chapter.] In this document I made the following prediction:

*"It is also stated that the Earth's magnetic North and the true North are different. However, I contend that they are not different in the sense that is suggested. The magnetic North and the true North are one and the same, the difference being mathematical points of contact in reference to the Earth and its movements through and by electromagnetic fields of force."*

**I was very certain from my own simple experiments and the known laws of electromagnetic induction that the Earth's magnetic field was being warped into Space as the Earth's magnetic field merged with the Sun's magnetic field.**

<sup>33</sup>  
F. Present astronomy teachings state that the Earth's magnetic axis makes an angle of approximately  $11\frac{3}{4}^\circ$  with respect to the Earth's true axis and that the magnetic axis and true axis are different. This conclu-

---

***"In essence, everything in the  
Universe moves in alignment with the  
gyroscopic-action-entity composition  
of their respective electromagnetic fields."***

---

sion has been made because the point on the Earth's surface where a magnetic pointer will point straight down was found to be approximately 1500 miles from the Earth's true axis of rotation. (See Figure 33-F.)

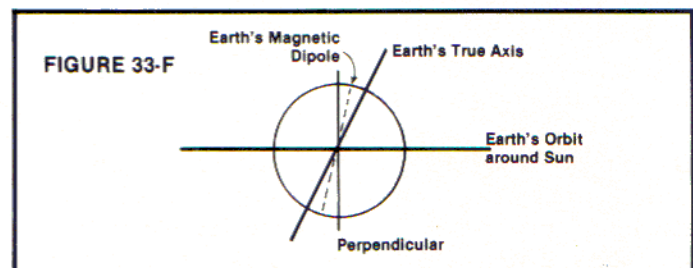

**QUESTION:** What would have been the conclusion if the Earth's magnetic axis had been found to be in the same location as the Earth's true axis?

This prior conclusion would appear to be a logical scientific conclusion until subjected to a rigid scientific scrutiny. Experimentation will verify that a smaller magnetic field will always be *warped* when brought under the influence of a larger magnetic field. The Sun has a larger electromagnetic field than the Earth's electromagnetic field. Consequently, I was certain that the Earth's electromagnetic field must be warped into Space. I was also certain that the Sun's electromagnetic field was warped as it aligned with our Galaxy's electromagnetic field. [I was also certain that the Moon's electromagnetic field aligned to the Earth's electromagnetic field and resulted in the Moon's observed motion and position in Space.]

For a number of years I diligently sought to have other scientists debate with me concerning my astro-

---

***“Experimentation will verify that a smaller magnetic field will always be warped when brought under the influence of a larger magnetic field.”***

---

nomical concepts. However, such an attempt on my part was to no avail. In 1974 I concluded from the known Facts in Astronomy that there would be a mathematical relationship of recorded astronomical data which should prove that I was correct. If I could assemble this data in view of my mechanical teachings, then others would listen and open their minds.

<sup>33</sup> **G.** The following data represents the very first information I assembled. I did not simply select these data figures from a large group of figures and then attempt to make them match. They are and were the only recorded figures available. I assembled this data and searched for a mathematical connection since all of my experiments and the known laws of electromagnetic induction convinced me beyond any doubt that there would be a connection.

<sup>34</sup> **A.** Since February, 1974, the amazing mathematical proof that I assembled represents the exact results I predicted from experiments in 1967! [Please observe that we will be discussing DEGREES X MINUTES. I conservatively used 90° X 60'. However, the possible angles could have been anything within 360° X 60'. The conservative numbers I use are more than sufficient for the PROOF which I sought.]

<sup>34</sup> **B. PROOF:** The Earth's magnetic axis at the Earth's surface “traces out” two circles every day, each circle having an approximate 23°, 30' cone that is equal to the radius of the circles having an approximate 23°,

27' cone traced out by the Earth's true axis every 25,800 years.

<sup>34</sup> **C.** The probable, mathematical odds of this data happening by accident are 29,160,000 to 1. (Degrees X minutes = 5,400 X 5,400.)

**QUESTION:** Why isn't the degree of angle between the Earth's true axis and its magnetic axis 89°, 2' or 3°, 58' or *any other* than 23°, 30', which produces mathematically exact results? (See Figure 34-J.)

<sup>34</sup> **D.** In Section 33-E, I have already stated that astronomy currently teaches that the Earth's true axis and the Earth's magnetic axis are different.

<sup>34</sup> **E.** In 1967, I predicted that the Earth's true axis and the Earth's magnetic axis were ***one and the same.*** Moreover, I predicted that the Earth's magnetic axis was being warped into Space by the Sun's magnetic field and such warpage caused the *effect* of the Earth's “true axis.”

<sup>34</sup> **F.** These mathematical Facts in Sections 34-B and 34-C are proof that my prediction is correct. (Sections 34-G and 34-H represent further proof.)

<sup>34</sup> **G.** The angular degree of the cone traced by the Earth's magnetic axis at the Earth's surface (approximately 23°, 30') is equal to the angular degree of the Earth's “true axis” to the perpendicular of the plane of its orbit around the Sun (approximately 23°, 27'). (See Figure 34-J.)

<sup>34</sup> **H.** The mathematical odds of probability for these measurements happening by accident are also 29,160,000 to 1, *i.e.*, 5,400 degrees X 5,400 minutes. (Refer to the “QUESTION” in Section 34-C since it applies here.)

---

***“In 1967, I predicted that the Earth's true axis and the Earth's magnetic axis were one and the same.”***

---

<sup>34</sup> **I.** Current astronomy teaches that a peculiarity of the of the Earth's position in Space is its tilt with respect to the plane of its orbit around the Sun. The Earth is canted at a fixed angle of approximately 23½ degrees. No further explanation is offered except to say “it just exists this way.”

<sup>34</sup> **J.** The mathematical Facts in Sections 34-B and 34-C combined with those of Sections 34-G and 34-H are strong proof that the Earth's true axis is the center of the cone traced by the Earth's magnetic axis. The Earth is tilted from the perpendicular of its orbit around the Sun by the warpage of the Earth's magnetic axis which aligns with the curvature of the Sun's magnetic lines of force. (See Figure 34-J.)

Left Side

Right Side

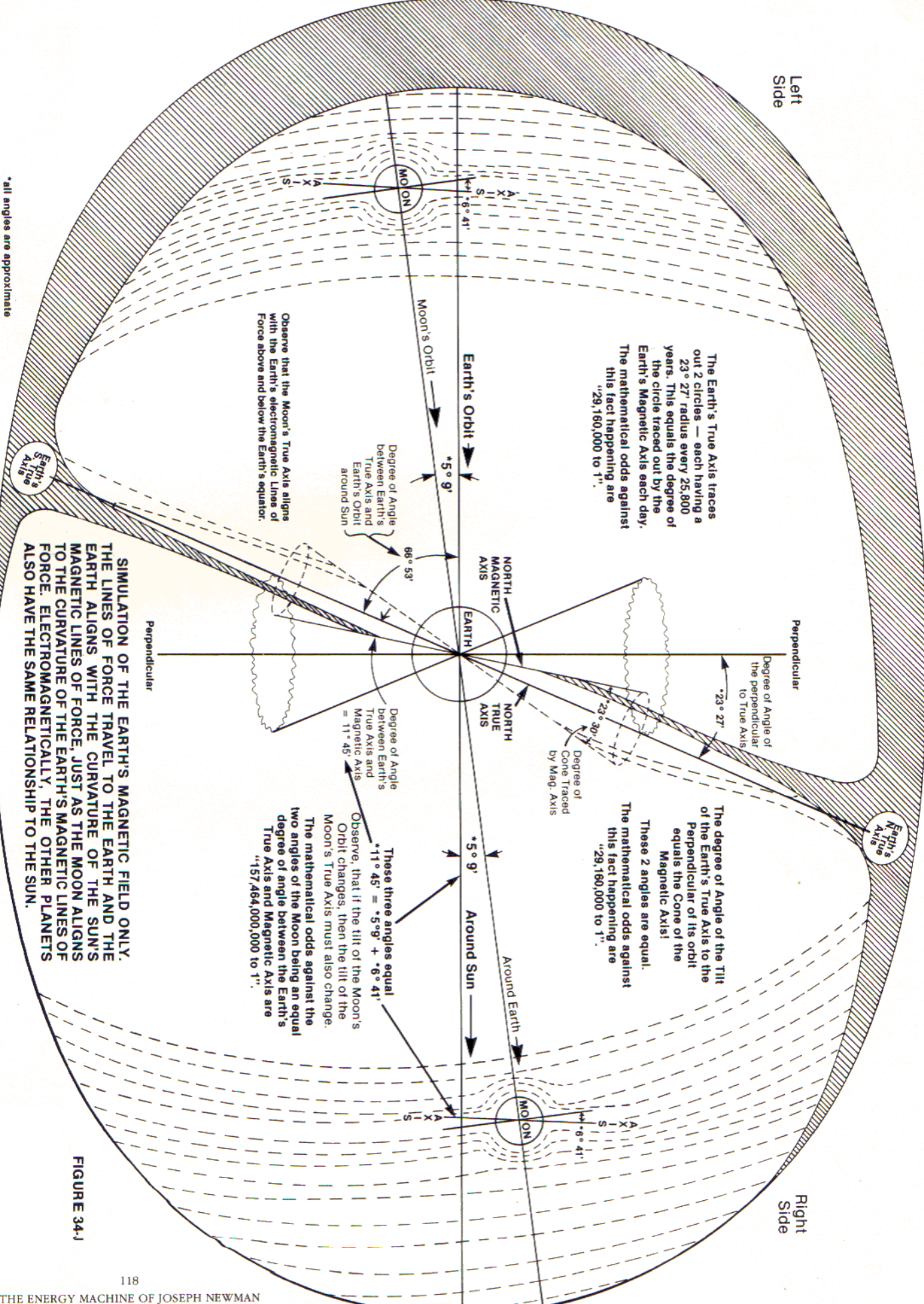

\*all angles are approximate

FIGURE 34-1

35. Current astronomy teaches that the Moon's axis is tilted by approximately  $6^{\circ}, 41'$  to the perpendicular of the plane of its orbit around the Earth.

<sup>35</sup>  
A. No reason is provided for such tilt other than "it exists this way."

<sup>35</sup>  
B. Current astronomy teaches that the Moon's orbit is inclined at approximately  $5^{\circ}, 9'$  to the Earth's orbit.

<sup>35</sup>  
C. No reason is provided for such orbital inclination other than "it exist this way."

<sup>35</sup>  
D. During my early research in 1967, I proposed 17 statements concerning how *all* bodies move in the Universe. One of these statements is:

"The degree of angle of any single body as it orbits another body depends upon several factors:

<sup>35-D</sup>  
(1) The number of degrees North or South past the magnetic equator that both poles of the orbiting body are within one pole of the particular body being orbited

<sup>35-D</sup>  
(2) The orbiting body's magnetic or electrical field

<sup>35-D</sup>  
(3) The orbiting body's weight and area

<sup>35-D</sup>  
(4) The distribution of the orbiting body's weight

<sup>35-D</sup>  
(5) The relation of the orbiting body to the rotation, magnetic or electrical field, weight, and area of the body being orbited."

<sup>35</sup>  
E. As related to the Moon, for example, what I am saying in Statement 35-D is the following: "Whatever degree of orbit the Moon has around the Earth would affect the tilt degree of the Moon with respect to the Moon's orbit. *Both the Moon's tilt and its orbit are affected by their relation to the Earth's magnetic and electrical fields.*"

<sup>35</sup>  
F. In 1974, the following statistics are the very first I assembled from available astronomy data. I must stress that I did not select these statistics from a large group of statistics and then attempt to match them. These were the only quoted statistics regarding the position of the Moon with respect to the Earth.

<sup>35</sup>  
G. The degree of angle of the Moon's orbital inclination with respect to the Earth's orbit (approximately 5 degrees, 9 minutes), plus the degree of angle of the Moon's axis-tilt with the perpendicular to its orbit around the Earth (approximately 6 degrees, 41 minutes) is equal to the degree of angle of the Earth's magnetic axis with respect to that of the Earth's true axis (approximately 11 degrees, 45 minutes). (Refer to Figure 34-J.)

<sup>35</sup>  
H. The mathematical odds for the probability of these statistics being "accidentally" equal are 157,464,000 to 1, *i.e.*,  $5,400 \times 5,400 \times 5,400$ .

#### QUESTIONS:

1. **Why isn't the degree of angle between the Moon's orbit and the Earth's orbit  $1^{\circ} 15'$ , or  $63^{\circ} 14'$ , or any other degree than the approximate figure which provides a continuous, mathematical relationship? (See Figure 34-J.)**

2. **Why isn't the degree of angle — for the tilt of the Moon's axis to the perpendicular of the plane of its orbit — any other than this exacting statistic? (See Figure 34-J.)**

3. **Why isn't the degree of angle between the Earth's true axis and the Earth's magnetic axis any other than this exacting statistic? (See Figure 34-J.) [The answers to QUESTIONS 1 and 2 equals approximately  $11^{\circ} 50'$  which equals QUESTION 3 of approximately  $11^{\circ} 45'$ .]**

<sup>35</sup>  
I. The mathematical facts and statistics in Sections 35-G and 35-H are strong proof that *both* the Moon's tilt (of its axis to the perpendicular of the plane of its orbit) and the degree of angle between the Moon's orbit and the Earth's orbit are indeed relative to the electromagnetic (gyroscopic particle) field of the Moon intertwining and aligning with the electromagnetic (gyroscopic particle) field of the Earth. As a crude analogy, one could imagine the Earth and Moon surrounded by billions of "invisible streams of gyroscopic particles" spinning at the speed of light and traveling at the speed of light where each gyroscopic particle within a given stream has an "electromagnetic coupling effect" upon the next gyroscopic particle to generate a hydraulic pressure throughout the entire "stream." In addition, each stream is capable of intertwining or meshing with and into one another. (As I have already shown, gravity represents the "Unobvious Effect" of the electromagnetic [gyroscopic particle] "Unequaling Effect." Refer to Figure 34-J with this knowledge in mind.)

<sup>35</sup>  
J. Please realize that I made rigorous statements predicting these results from mechanical tests conducted seven years *before* I obtained these astronomical statistics. In addition, I discovered the Fact that all the recorded astronomical statistics coincide *exactly* with the prediction, *i.e.*, the mathematics of probability indicate that the chances of the Facts occurring "by accident" are so unlikely as to be almost impossible.

36. Because they were unjustly taught in Astronomy to memorize the statement "the Sun's magnetic field reverses on a 22-year cycle," there are those who will blindly state that all of the above Facts discussed in this Chapter are incorrect.



36  
A. The following represents my scientific reasoning concerning why the Sun's general magnetic field **does not reverse**:

36  
B. Present scientific data states:

“Sunspots fade in strength every eleven years. This pattern is but a phase of a twenty-two year cycle in which the Sun's magnetic field reverses itself.

“The eleven-year cycle of the number of sunspots doubles if the difference in magnetic polarity is taken into account. Information shows the polarity of the leading spot in a bipolar group during a cycle in one hemisphere have North polarity, while those in the other hemisphere have South polarity. As the cycle progresses, the spots appear, on the average, at lower latitudes. However, the leading spots of the Northern hemisphere still have a North polarity and those of the Southern hemisphere a South polarity. During the next eleven-year cycle, the leading spots which appear at high latitudes of both hemispheres are of reversed polarity. Therefore, the real cycle of the sunspots is 23 years and not 11.5, which would be the length of the cycle if the spots were judged solely on their number. And that one major reversal of the Sun's magnetic field took place in 1957-1958 when sunspot activity was at a maximum, During this period, the North magnetic pole of the Sun became magnetically a weak South pole and the South pole became a weak North pole.”

36  
C. Present scientific data also states:

“... how magnetic fields of the sunspots and of the Sun are studied by the Zeeman Effect (the phenomenon of spectral lines splitting due to the presence of a magnetic field of sufficient intensity) and that it is not easy to measure solar magnetic fields of hundreds of gauss. This raises the question: does the Sun have a permanent, general magnetic field?

“If a permanent magnetic field were present, it would be manifested as a widening of the spectral lines from any point on the photosphere and not just from the sunspots. Because the spectrum of the photosphere is often observed with extremely sensitive instruments, it can be stated with certainty that if such a general field exists, it must be extremely weak. Its intensity cannot be greater than some tens of gauss.” (Emphasis added.)

36  
D. In conjunction with my experiments that follow, these above two quotations present factual, scientific arguments as to why the Sun's general magnetic field has not been observed, but only the general polarity of sunspot activity.

From my original writings, the following information provides a description and drawing of an experiment I conducted on Wednesday, 10 P.M., April 3, 1968: (See Figure 36-D.)

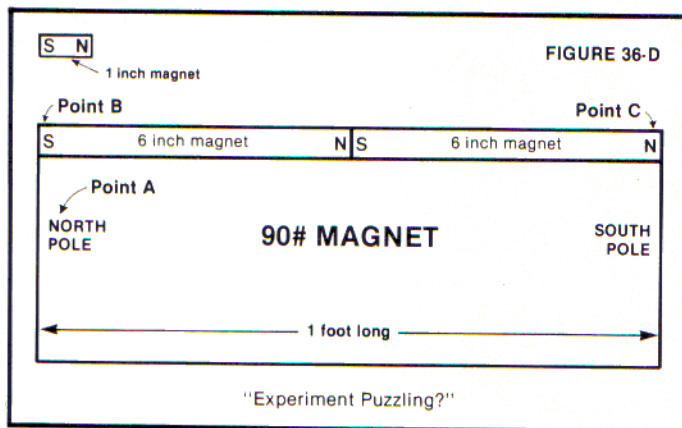

“When a large 90-pound magnet (previously described) is laid down and two, smaller, 1-inch diameter, 6-inch long magnets are placed end to end and placed where they are attracted parallel to the 90-pound magnet, they appear to have the same polarity as the large magnet to which they are attracted.

“There should be a South pole at point B and a North pole at point C, but when the South pole of a smaller ¼-inch diameter, 1-inch long magnet is placed at point A on the large, 90-pound magnet and is attracted, it should be repelled at point B on the 6-inch long magnet's South pole. However, it is attracted there also, but if they are taken away from the 90-pound magnet in the same position as when they were attracting, they then repel — ?”

Only after I conducted further experiments did I understand what was happening and that there was a repelling of the South pole of the smaller magnet when placed at the very end of the South pole of the 6-inch long magnet.

---

**“... whenever there is a stronger magnetic field merging with a weaker magnetic field, the true polarity of the weaker magnetic field should be stated with caution.”**

---

36  
E. Scientifically, this experiment proves that whenever there is a stronger magnetic field merging with a weaker magnetic field, the true polarity of the weaker magnetic field should be stated with caution. Similarly, sunspots' magnetic fields have been found to possess strengths of up to 500,000 gauss. With a low strength of tens-of-gauss measured during sunspot activity, the Sun's general magnetic field should be stated with caution. The Sun's general magnetic field will be considerably weaker than sunspot magnetic fields at any one point. However, because of the *total size* of the Sun's general magnetic field, such a field is *immensely stronger than all the sunspot fields combined.*

36  
**F.** An additional experimental comparison follows:  
 (Refer to Figures 36-F1 and 36-F2.)

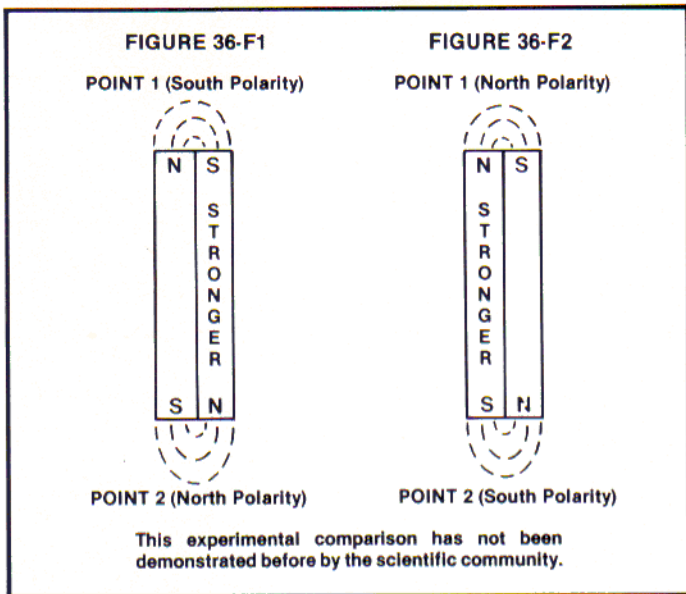

When two magnets are placed parallel, as in Figure 36-F1, they will have a weaker general polarity at points 1 and 2 (caused by the merging of the two fields) in the same manner as the magnet with the strongest field. If the strengths of the two magnets are reversed as in Figure 36-F2, the weaker general polarity at points 1 and 2 will reverse.

36  
**G.** Consequently, if imaginary lines are drawn from the leading and following spots in the Northern Hemisphere, one will have a drawing of the Sun as depicted in Figure 36-G:

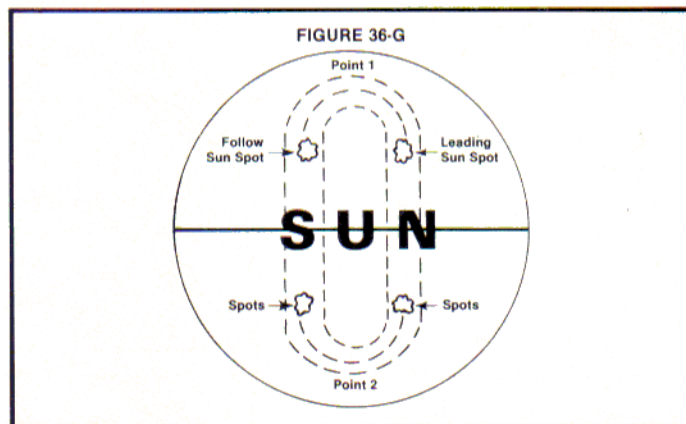

There will be a weaker general field of the sunspots at points 1 and 2 depending upon which magnetic field is strongest. If the poles reverse in polarity but maintain the strongest field, the weaker general field at points 1 and 2 will also reverse. If the polarity of the poles remain the same but the strength of the poles reverse in terms of which side is stronger, then the weaker general field at points 1 and 2 will also reverse.

36  
**H.** Therefore, I have presented a sound scientific and factual argument that the polarity of the Sun's general magnetic field has not been studied by the Zeeman

**Effect, but the general field of sunspot activity was studied instead.**

**QUESTION:** Have you, the reader, Mastered what I have taught? Do not blindly accept what I teach, but question the "Facts" for yourself. Similarly, do not blindly accept what one was originally taught to "memorize" when one studied Astronomy.

I have questioned previously accepted concepts and the "Facts" have clearly convinced me that what I teach is indeed correct. Based upon these "Facts" combined with a "rigid format of Logic," you must decide for yourself what is "true" and what is "false." As one who values scientific precision, I urge you to discard what is "false" and adhere to what is "true"!

37. **A. EXAMPLE:** Consider the statement, "The Moon presently has no magnetic field, it is unlikely that Venus has a magnetic field, and Mars may have a very small magnetic field."

The above statement was proposed by scientifically-oriented individuals. As a scientist, I was astonished that anyone could seriously accept such a statement. I now understand that such individuals have been unjustly influenced by a teaching system which rewards memorization and penalizes serious questioning of statements which may currently be accepted as true.

37  
**B.** Well over 100 years ago, Michael Faraday clearly demonstrated that **neutrality to a magnetic field does not exist!** The Facts known prior to my teachings clearly demonstrate that the Laws of Electromagnetic Induction apply to planets, stars, etc., *if there were any magnetic fields involved.* From my own experiments with magnets and the known Laws of Electromagnetic Induction, I was strongly predicting such astronomical results in 1967.

37  
**C.** In 1967, while I was predicting that the Moon would be found to have a magnetic field, everyone else (whose work I read) was saying that the Moon did not or would not be found to have any magnetic field of any consequence. For example, after an analysis of the Explorer 35's results, it was concluded that if a permanent lunar field existed, its magnitude would be less than two gammas. The Moon was considered magnetically dead by the scientific community.

In contrast, I was so positive that the Moon would have a magnetic field — my attitude being based upon my experiments — that I wrote Dr. Robert R. Gilruth (the previous director of NASA) a letter on January 3, 1969 still predicting that the Moon would be found to have a magnetic field when the astronauts made their first landing on the Moon. *If my predicted results were not corroborated, then I would readily admit that my document of 1967 was wrong;* but if I was correct, then my comments should be given immediate attention. (See copy of my letter [37-C1] to Dr. Gilruth dated January 3, 1969 and the copy of Dr. Gilruth's letter [37-C2] to me dated January 21, 1969.)

3062 Pickell Drive  
Mobile, Alabama 36605  
January 3, 1969

Dr. Robert R. Gilruth, Director  
NASA Manned Space Flight Center  
Houston, Texas 77058

Dear Dr. Gilruth:

I have been advised by Mr. Ben James of Public Affairs that you could assist me in my endeavor.

Two years have passed since I wrote a Scientific Document on How Bodies Move in the Universe, and I have been unable to get any other scientist to prove or disprove my document!

Enclosed please find a list of fifty-six colleges that received a copy of my document at their Department Head of Physics and Department Head of Astronomy, where applicable. Very few even offered the courtesy of acknowledging that they had received my document, and even fewer made comment. (Please see attached)

Also enclosed you will note a copy of a letter from Huntsville Space Administration and National Science Foundation to which there has been no follow-up correspondence.

Also please note the enclosed copy of my Scientific Document and a scientific article which I had printed in the Mobile Press, December 22, 1968, at a cost of \$650.00.

On or about February of 1967, my patent attorney, Harold J. Birch, with the firm of Irons, Birch, Swindler, and McKie in Washington, D. C. arranged an appointment for me and approximately six (6) scientists at Houston Space Center for the purpose of expressing an opinion on my document. Unfortunately, I have since lost the names of these gentlemen. They were quite courteous but did not contribute a definite statement except to say that I may or may not be correct and that the burden of proof was on me. One of the scientists, whom I liked because he seemed to have an open mind for new opinions, kept a copy of my document.

I have made my livelihood by inventing since 1961 and I have always told my clients that I would let my creative ability speak for itself. Therefore, since the burden of proof is on me, I would again like to bring attention to a prediction that I made two years ago, that the moon's axis would be found to have an angle toward the earth in relation to its magnetic field. (See page 12 of my scientific document.)

Dr. Robert R. Gilruth  
January 3, 1969  
Page 2

My purpose is strictly scientific and any comments I have made and offered in my document and article are based on numerous costly experiments made and paid for by me, plus countless long hours of deep creative thinking. I humbly ask that the following experiment be made when the Astronauts make their first landing on the moon, which hopefully will be in the very near future. This experiment will let my ability, or lack of creative ability, speak for itself. If this prediction is not as I have stated, I will readily admit that my document and article are wrong, and that I have wasted my time, as well as that of others, to whom I would greatly owe an apology. However, if I am correct, I think it would be appropriate that my comments be given immediate attention.

My prediction for proof is as follows:

The moon will have a magnetic field located within 12 of its axis or already designated North and South Pole. However, what has been stated by scientists as the moon's North Pole will have a South Magnetic Pole within 12 of same. And what has been stated by scientists as the moon's South Pole will have a North Magnetic Pole within 12 of same. (This would have to be shown with a compass made with a high grade of alnico 5 material. Because a compass made of material that doesn't strongly retain its particular magnetic fields can have its polarity changed if quickly shoved into a stronger magnetic field.) If a magnetized pointer is used as a compass and one end is marked that points North on the Earth, it will point to the moon's South Pole, which will be the Moon's North Magnetic Pole.

Please inform me at your earliest convenience as to what I may expect in reference to my request and any scientific comments would be welcomed!

Sincerely,

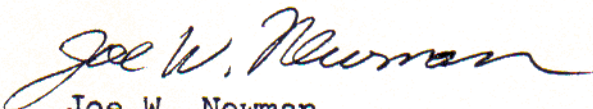

Joe W. Newman  
3062 Pickell Drive  
Mobile, Alabama 36605

Attachments



NATIONAL AERONAUTICS AND SPACE ADMINISTRATION  
MANNED SPACECRAFT CENTER  
HOUSTON, TEXAS 77058

IN REPLY REFER TO: TA

JAN 21 1969

Mr. Joe W. Newman  
3062 Pickell Drive  
Mobile, Alabama 36605

Dear Mr. Newman:

Thank you for your interesting document on the space program. The magnetic field of the moon is an area we have worked on some in the past. The U. S. satellite, Explorer XXXV, as you probably know, went into orbit around the moon carrying a magnetometer. This instrument, as well as a similar instrument on the Russian lunar lander, Luna 9, showed that the magnetic field of the moon is very small. It is less than one thousandth of the earth's magnetic field and may be zero. Even if the field of the moon were zero, in a short time it would have collected a small magnetic field which would be transported from the sun via the solar wind. We think probably this is the nature of the present magnetic field of the moon based on the experiments which have been carried out so far.

We currently have plans for placing a very sensitive magnetometer on the surface of the moon in the second lunar landing. The payload for the first lunar landing has already been determined. The magnetometer will try to study the field of the moon in more detail and for a longer period of time in order to determine whether it is, as we suspect, controlled by the sun. The result of this experiment will be published in the scientific literature made available to the press as soon as it is available.

Thank you very much for your interest.

Sincerely,

A handwritten signature in black ink, which appears to read "Robert R. Gilruth".

Robert R. Gilruth  
Director

<sup>37</sup> **D.** Since the Moon was considered magnetically dead, the first Apollo 11 landing was not even scheduled to carry a magnetometer. However, on November 12, 1969, the scientific community was very excited and surprised when an instrument measured a permanent magnetic field of **38 gammas** at the Apollo 12 landing site. Then in February, 1970, the Apollo 14 crew measured a magnetic field of **43 gammas** and **103 gammas** at two different locations near their landing site which was 110 miles east of Apollo 12. During a time period around August 1, 1971, the Apollo 15 crew measured a magnetic field of **6 gammas** at their landing site. Then, in April, 1972, the Apollo 16 crew measured a surprisingly high magnetic field of **313 gammas** at their landing site. The Apollo 17 mission did not carry a magnetometer. [NOTE: A gamma is a unit of magnetic intensity, equal to  $10^{-5}$  oersted.]

The magnetic field measurements obtained at the Apollo sites combined with the high magnetic remanence found in rock samples returned from all the Apollo sites, demonstrate that the Moon is magnetized in all visited regions.

<sup>37</sup> **E.** I strongly predicted these results before the first lunar landing, but these were not the results predicted by the scientific community before the first lunar landing.

<sup>37</sup> **F.** Because the direction and intensity of the Moon's magnetic field varies and is based upon measurements recorded in Space by satellites, some scientists have offered the hypothesis that the Moon's permanent field is only localized.

I do not consider this a correct scientific conclusion. Even the Earth's magnetic field is described "like the wanderings of a snail," and its intensity varies greatly over different mineral deposit areas. My experiments have scientifically demonstrated the complications of determining strength and polarity of a weak magnetic field at a distance from its source, as did the Russian Luna 10 and the U.S. Explorer 35 experiments conducted before the first manned Moon landing. The reader may find it interesting that after the measurements of the Moon's magnetic field were recorded, a new article stated: "No one predicted the magnitude of the Moon's magnetic field." I brought this news statement to the attention of one physicist and my original, strong prediction before-the-fact, and the physicist's reply was that "I had a 50-50 chance of guessing this Fact." **QUESTION:** Do you, the reader, believe that the Facts indicate I was only guessing?

<sup>37</sup> **G.** From my experiments, the laws of magnetic and electric fields, and the "Facts," I am certain that the Moon has a general magnetic field which is considerably weaker than the Earth's field. I am also certain that a magnetic field will be found at any other manned landings made on the Moon, Venus, or Mars.

<sup>37</sup> **H.** The mathematical statistics presented in Sections 33-E through 35-J certainly prove that I am correct since I assembled such statistics seven years after my original prediction.

**38. A.** Let's examine other current statements in Astronomy. The following information is quoted from the two books, *Astronomy* and *Frontiers of Astronomy* by eminent astronomer Fred Hoyle. [*Astronomy* is published by Rathbone Books, Ltd., London, 1962; *Frontiers of Astronomy* is published by New American Library, New York, 1964.] From *Astronomy*, page 260:

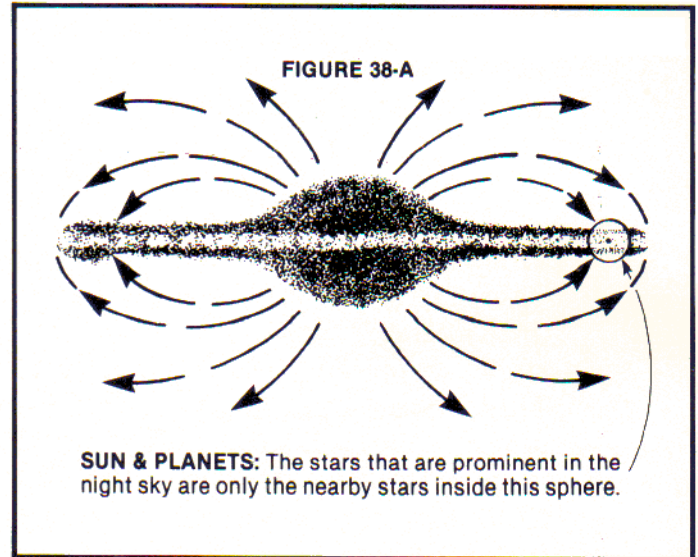
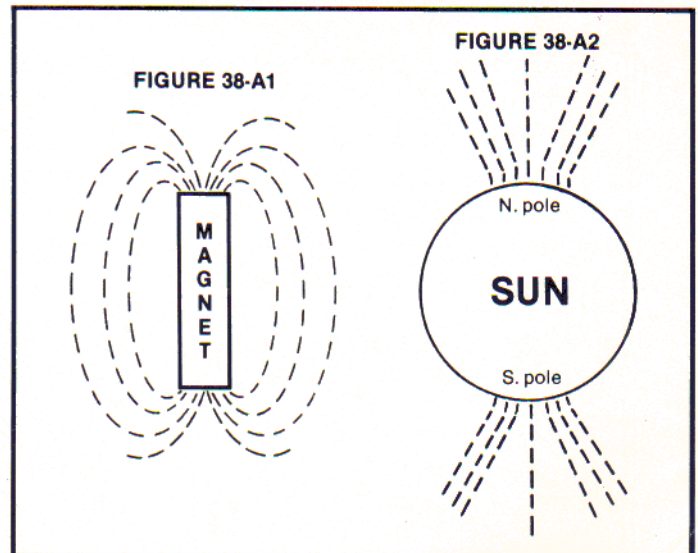

Figure 38-A is a "schematic representation of the magnetic field of a galaxy. Lines of force seem to be aligned mainly parallel to the galactic plane. It is strongly suspected that a magnetic field pervades our galaxy."



The fact that the Earth and Sun have magnetic fields is well known. However, quoting from Fred Hoyle's book, *Frontiers of Astronomy*, page 106: "The problems of the Sun's field is not as simple as that of an ordinary magnet." Figure 38-A1, "shows the pattern in which iron filings arrange themselves around an ordinary magnet."

“... a careful examination of the polar plumes of the corona suggests that the lines of force emerging from the poles of the Sun show the behavior indicated in Figure 38-A2. The lines of force apparently make a bee-line dead away from the Sun, and the farther they go the less indication there seems to be that they are ever going to curve round and join up with the lines of force from the other pole. *Where do these lines of force go to? This question raises a puzzle to which there is no agreed answer.*” (Emphasis added.)

38

**B.** To simply demonstrate the observations of Section 38-A, I conducted the following test:

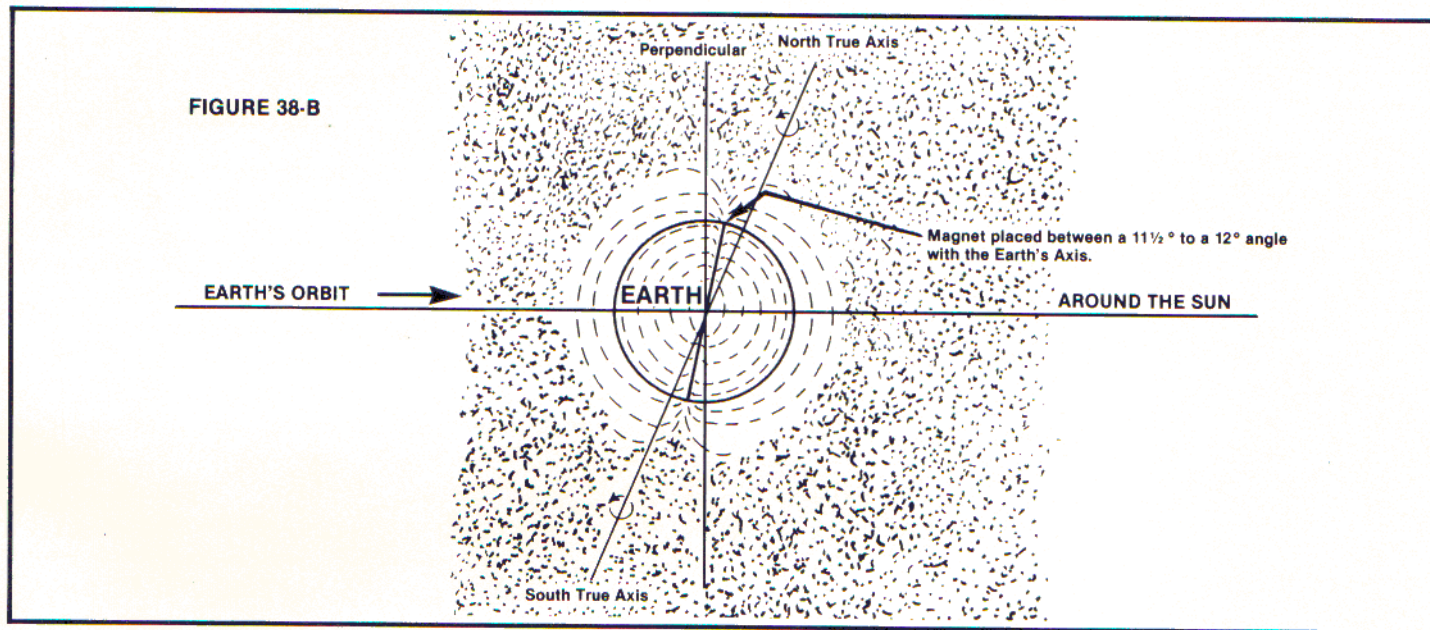

I scratched the drawing in Figure 38-B on a clear plastic rectangular pan (10½” wide by 17” long) and filled in the scratches with red paint so the image could be easily seen. Then I taped a small magnet (¾” long by 1/16” diameter) under the plastic pan as shown. I sprinkled the plastic pan with iron filings. When the plastic was physically tapped, the iron filings arranged themselves as shown. The iron filings not in the immediate vicinity of the scratched drawing were not aligned by the small magnet. It is easily seen that the magnetic lines of flux in Figure 38-B align as they do in Fred Hoyle’s Figure 38-A1, but not as shown in Fred Hoyle’s Figure 38-A2.

38

**C.** However, when the Figure 38-B experiment is physically moved to the vicinity of the equator of a large, 90-lb. magnet, the results are as follows:

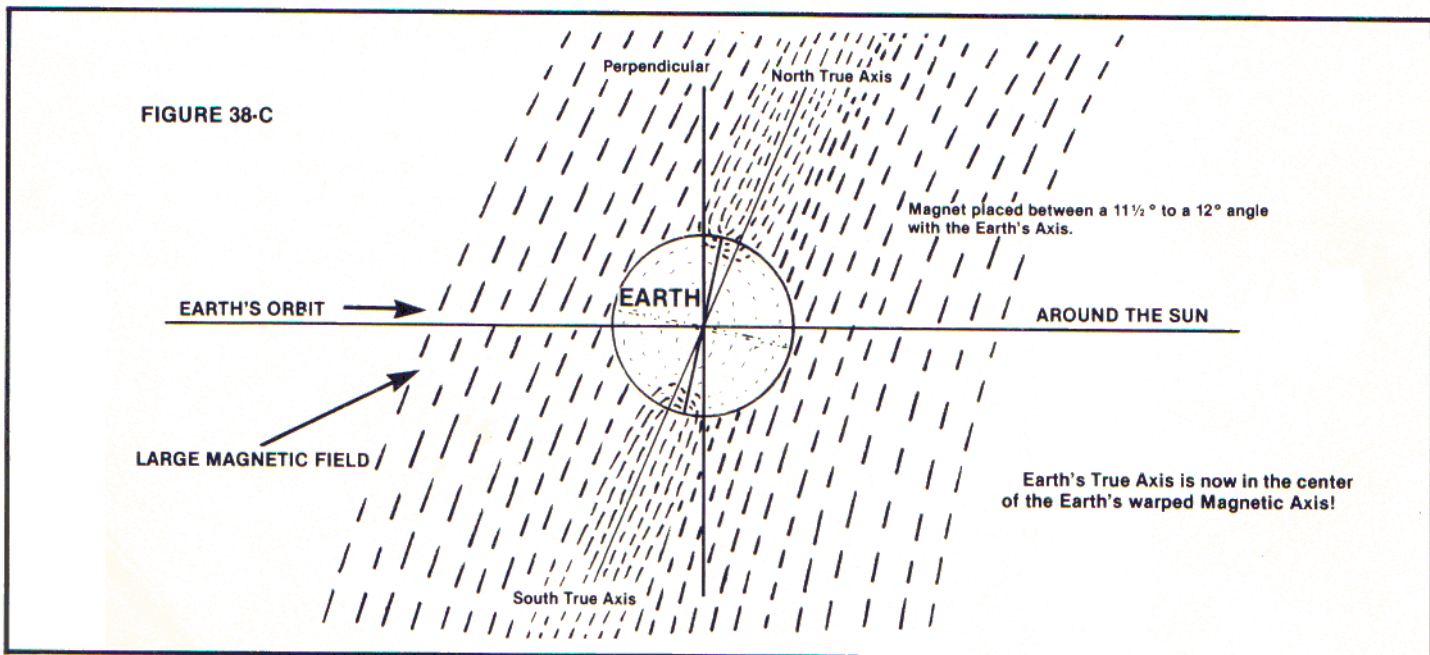

From Figure 38-C one can deduce the following:

<sup>38-C</sup>

(1) The magnetic field depicted in Figure 38-B is now immediately warped.

<sup>38-C</sup>

(2) When the experiment is physically tapped, the iron filings on the scratched circle in Figure 38-B travel to the North and South poles or the magnetic equator as shown in Figure 38-C. (This effect varies depending upon the distance separating the larger and smaller magnetic sources.)

<sup>38-C</sup>

(3) The iron filings not previously moved by the small magnet all align with the magnetic field of the large magnet. Such filings beautifully align with the iron filings in Figure 38-C and cause the Earth's true axis to be in the *center* of the Earth's warped magnetic axis. (Compare Figure 38-C to Figure 34-J.)

It is easily seen that the magnetic lines of flux in Figure 38-C do not align as they previously did in Figure 38-B, or as they do in Fred Hoyle's Figure 38-A1, but do align as shown in Fred Hoyle's Figure 38-A2, since they move directly *away* from the small magnet. Therefore, the question raised by the observation of the Sun's magnetic field shown in Fred Hoyle's drawing in Figure 38-A2 — upon which there previously was no agreed answer — is now answered. My simple experiment demonstrates that the Sun's magnetic field connects with a far larger magnetic field: *our galaxy's magnetic field* as shown in Fred Hoyle's Figure 38-A.

<sup>38</sup>

D. The true depiction of our Sun's magnetic field should be shown as in Figure 38-A of our Galaxy's magnetic field. The polar plumes of the Sun's corona appear in Fred Hoyle's Figure 38-A2 simply because that area of the Sun has the strongest magnetic lines of force which contain strengths that dominate the Sun's polar plumes. Examine the two, top and bottom center arrows of Figure 38-A and compare those to the ones in Figure 38-A2. You will see that such effects are a duplicate of one another. (See Figure 38-D.)

FIGURE 38-D



<sup>38</sup>

E. The results of Figure 38-A combined with my teachings and the known Laws of Electromagnetic Induction clearly demonstrate that our Sun and all of its planets are affected and governed by the electromagnetic effect since:

(1) **gravity represents the "Unequaling Effect" of the Unobvious Effects of the electromagnetic composition of all Matter and,**

(2) **magnetism and electric charges are composed of the same gyroscopic-action-particle that is the basic building entity of all Matter.**

39. Let's examine my explanations for other astronomical statements:

<sup>39</sup>

A. Astronomy teaches that the Moon has a slow rotation and that at all times it keeps the same hemisphere turned towards Earth.

<sup>39</sup>

B. Popular Explanation: "In the remote past, the Moon rotated more rapidly, but the drag of the tides induced within its once-plastic body by the more massive Earth, robbed the Moon of its spin. Moreover, the Earth's gravitational pull upon a *slight bulge on the side of the Moon facing the Earth* is probably responsible for its continually facing the Earth."

<sup>39</sup>

C. On August 4, 1971, a scientific finding was published that the Moon is lopsided with the bulge on its backside. (This contradicts the hypothetical "popular statement.")

---

***"I therefore concluded that the Moon keeps the same face towards the Earth because the Moon is close to the Earth and the magnetic and electrical alignment of the Moon's and Earth's Fields of Force are stronger than the centrifugal force."***

---

<sup>39</sup>

D. From experiments I conducted in 1966 — with small magnets covered with varying amounts of clay and fixed where they could orbit around a larger magnet — I observed the following results:

The smaller magnet was observed to make an elliptical orbit; it was observed to spin in the direction it was traveling; and it was observed that when the orbital path of the smaller magnet around the larger magnet reduced, the speed of its motion around the larger magnet increased. It was also observed that *when the smaller magnet approached the larger magnet, it would begin to maintain the same face towards the larger magnet.* This result would cease if the orbit became extremely elliptical which caused the smaller magnet to spin erratically.

<sup>39</sup>

E. I therefore concluded that the Moon keeps the same face towards the Earth because the Moon is close to the Earth and the magnetic and electrical alignment of the Moon's and Earth's Fields of Force are *stronger than the centrifugal force.* (If the Moon moved farther from the Earth, then the Moon would start spinning.)



40. Based upon my experiments and the Laws of Magnetic and Electrical Fields, I made the following statement in 1967:

40  
A. "It would be a violation of the proven laws of magnetism and electricity **for a body orbiting the Sun not to continuously attempt to align its magnetic lines of flux with the magnetic lines of flux of the Sun.** As a result, the orbiting body's **degree of angle, speed, elliptical orbit, and the rotation on its axis will vary** as the distance varies between the orbiting body and the Sun."

40  
B. In October, 1970, I read the following scientific information:

"*Analysis of data by Stoyka at Paris Observatory has revealed accelerations and retardations of the Earth's rotation over the very short period of about one year.*"

"*The last word has not yet been said on this matter and there is still much to be done. Astronomers, though, justifiably worry about it.*"

40  
C. This is precisely what I predicted in 1967 via statement 40-A: "... and rotation on its axis will vary ..."

40  
D. In the December 13, 1968 issue of *Time Magazine*, page 54, I read the following scientific information:

"*Instead of spinning smoothly, the Earth wobbles on its axis. By sighting telescopes on distant fixed stars and carefully measuring their apparent movement, scientists have determined that the North and South poles — the points at which the imaginary axis of rotation pierces the Earth's surface — are continually on the move. Over the course of a year, they wander about the polar regions in roughly circular paths about 50 ft. in diameter. The cause of the erratic wobbling motion has long been a geophysical mystery.*"

40  
E. Again, this is exactly what I predicted in 1967 via statement 40-A: "... degree of angle ... will vary ..."

40  
F. I also read this scientific information:

"*The Magnetic Poles wander, proved also in 1912 in the South Pole by observations of several months, the pole wandered along the arc of a five-kilometer circle.*"

There was no reason or explanation provided for such "wandering."

40  
G. Once again these results are exactly what I predicted in 1967 via statement 40-A: "... a body orbiting the Sun ... (will) ... continuously try to align its

magnetic lines of flux with the magnetic lines of flux of the Sun."

40  
H. These scientific observations which I read and my comments in Sections 40-A through 40-G coincide exactly with the results described in Figure 34-J along with the mathematical proofs in Sections 34-B through 34-H that the Earth's true axis is generated by the Earth's magnetic axis. The scientific observations of Section 40-D and Section 40-F demonstrate that the Earth's true axis traces a small circle which is the result of the larger circle traced by the Earth's magnetic axis in the period of one year!

40  
I. It is doubtful that the circles described in Section 40-D or Section 40-F will be closed circles. Such circles would be open because the motions of the Sun as it orbits within our Galaxy — combined with the forward motion of our Galaxy — prevents the Earth from tracing the exact same orbit as the previous year. (See Figure 40-I.) Therefore, by conducting measurements on distant stars one will observe similar circles as described in Section 40-D and Section 40-F.

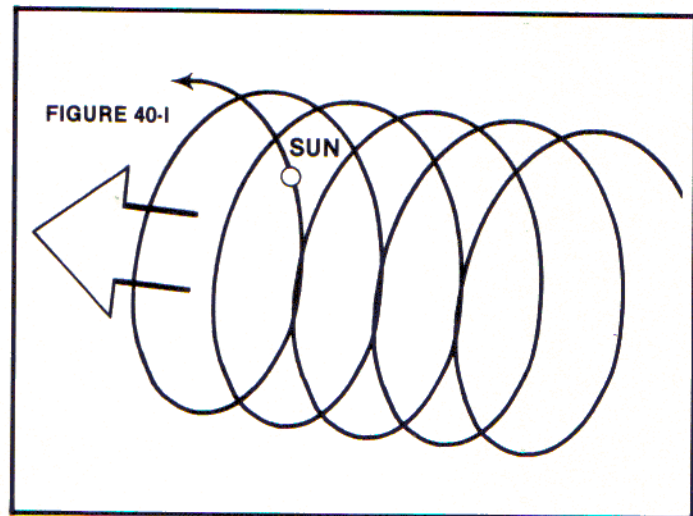

41. A. Astronomy teaches that the planet Pluto has the greatest inclination of any planetary orbit. All other planets move in orbits that are only slightly inclined to the ecliptic, *i.e.*, the Earth's orbit around the Sun. The exception to the rule is Pluto which lies on a plane about 17 degrees with the ecliptic. (See Figure 41-A.)

41  
B. Popular explanation for Pluto's inclination: "Pluto may be a lost satellite of Neptune."

41  
C. My experiments have shown me that the further from the *source* of a magnetic and electrical field of force — when that *source* is engrossed in a larger magnetic and electrical field of force — the greater the warpage of the lines of forces of that *source*.

41  
D. This warpage is generated by the inertia of the *source* wanting to carry that source in a straight line as it orbits another source.

FIGURE 41-A

THE SUN'S TRUE AXIS IS A RESULT OF THE SUN'S MAGNETIC AXIS (AS EARLIER DEPICTED FOR THE EARTH) ALIGNING WITH THE CURVATURE OF THE GALACTIC MAGNETIC AND ELECTRICAL FIELDS OF FORCE.

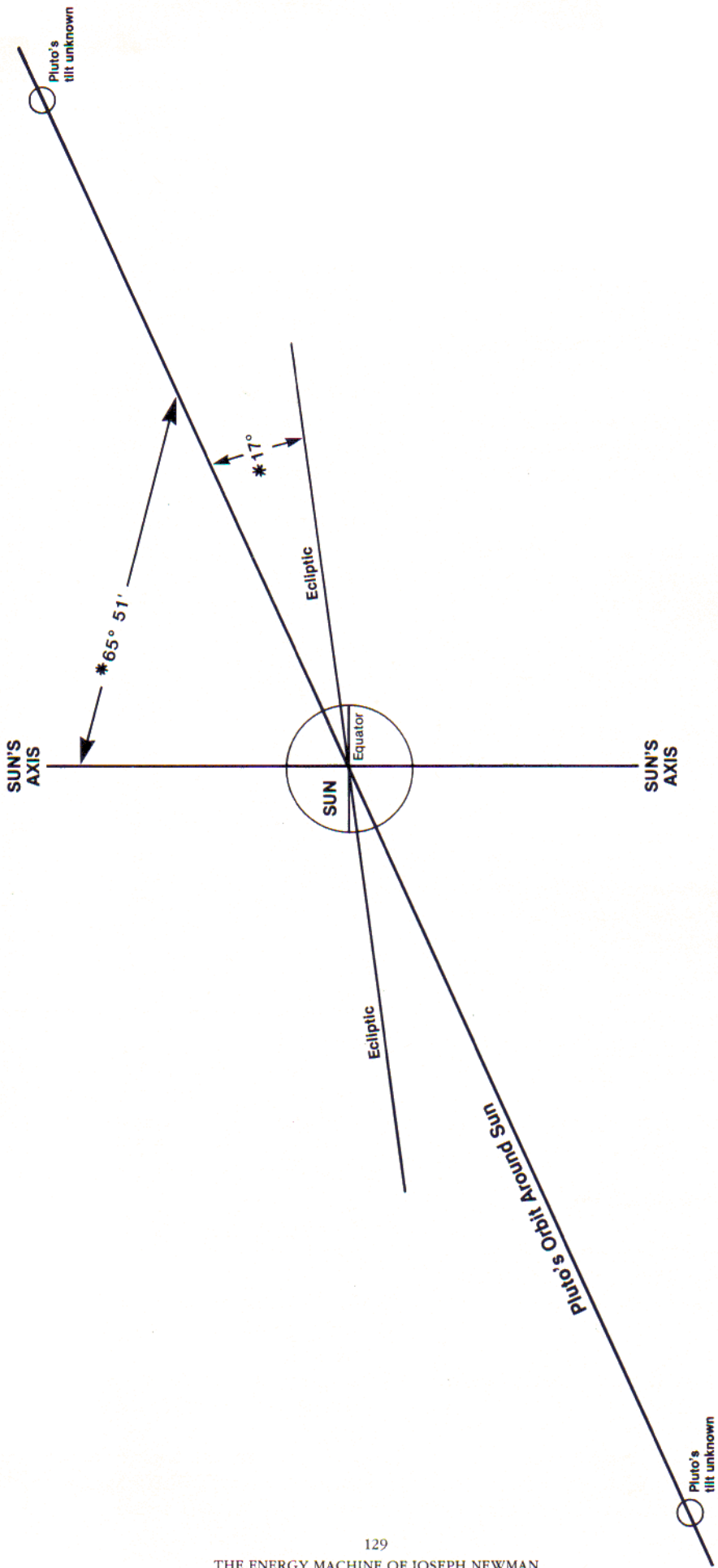

Compare the degree of the angle between Pluto's Orbit and the Sun's True Axis to the degree of the angle between the Earth's Orbit and the Earth's True Axis. (See Figure 34-J.) They are equivalent! This indicates a mathematical relationship throughout the Solar System caused by each smaller body aligning itself with the larger curvature of the Magnetic and Electric lines of force of the larger body which the smaller body orbits.

\* Approximate figures

<sup>41</sup>  
**E.** Pluto is 3,670,000,000 miles from the Sun (the *source*) or 39.5 times the distance of the Earth from the Sun. Therefore, due to the inertia of the Sun, the Sun's magnetic and electrical fields of force begin to warp as they continuously try to align with our Galaxy's magnetic and electrical fields of force.

<sup>41</sup>  
**F.** Because of confidence in the veracity of my experiments, I searched years ago for mathematical proof that Pluto's magnetic and electrical fields of force do in fact align with the Sun's magnetic and electrical fields of force.

<sup>41</sup>  
**G.** An additional mathematical argument is now presented! The degree of angle of Pluto's orbit to the true axis of the Sun (approximately 65°, 51') closely equals the degree of angle of the Earth's orbit to its true axis (approximately 66°, 53').

<sup>41</sup>  
**H.** The mathematical odds of the probability of these figures "happening by accident" are 29,160,000 to 1, *i.e.*, 5,400 X 5,400.

<sup>41</sup>  
**I.** I have already presented strong proof that the Earth's orbit and true axis are the result of the Earth's magnetic axis aligning with the curvature of the Sun's magnetic and electrical fields of force.

<sup>41</sup>  
**J.** The same mathematical relationship has occurred again! This indicates to me that the same mathematical relationship operates throughout the Solar System! Such is the case because every smaller body aligns with the larger curvature of the magnetic and electrical lines of force of the larger body which the smaller body orbits.

**42. A.** Further experimental proof of my Theory follows:

The following results were observed from the experiment pictured in Figure 42-A:

<sup>42</sup>  
**B.** When the small magnet was maintained in a flat position in the small dish, it would always travel to the magnetic equator of the larger magnet regardless of where the small magnet was originally placed in the pan of water.

<sup>42</sup>  
**C.** When the small magnet was tilted a small amount with one end upward, the small magnet would travel slightly North or South of the large magnetic equator, depending upon which end of the small magnet was actually tilted.

<sup>42</sup>  
**D.** When the small magnet was tilted even more, it would travel even further North or South of the large magnetic equator.

<sup>42</sup>  
**E.** When the plastic pan of water was lowered too close to the large magnet, the small magnet would start to tilt at an extreme angle and would move further North or South of the large magnet's equator. This process would continue until the small magnet was pulled under the water which would cause the small dish to sink.

<sup>42</sup>  
**F.** As a result, this experiment explains why all the planets orbit in the vicinity of the Sun's magnetic equator in varying degrees of angle due to electromagnetic alignment and the warpage of the Sun's electromagnetic field. This experiment also explains why most stars orbit in a galactic plane. [I also predict that galaxies also orbit within the plane of their respective Central Entity. (See Section 52-M.)]

<sup>42</sup>  
**G.** This experiment also provides an explanation of why sunspots always travel to the Sun's equator and

**FIGURE 42-A**

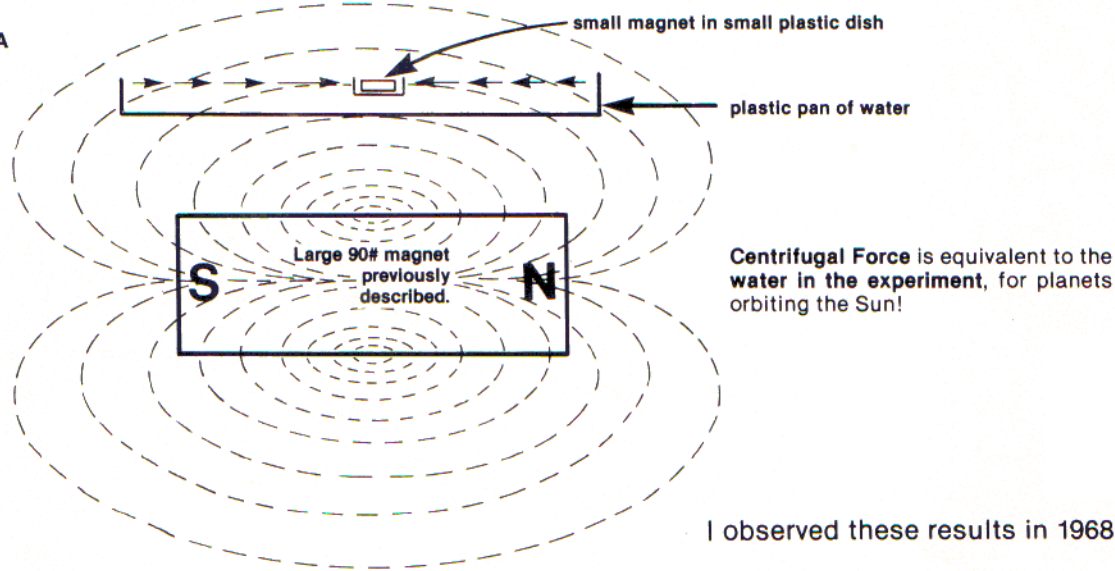

Simulation of the Sun's Magnetic and Electrical Lines of Force only. (Such lines of force emanate from the Sun in a mathematical order and are warped differently as the distance varies.) The Planets' degree of angle of their orbit to the Sun's True Axis and their tilts to their own orbit are controlled by their respective Magnetic and Electrical Lines of Force aligning with the Sun's Magnetic and Electrical Lines of Force! Such action is exactly that which was demonstrated and described for the Moon in Figure 34-J.

This Figure depicts the planets' degree of Angle of Orbit to the Sun's Axis (and above the Sun's Equator) as well as their Degree of Tilt of Axis to their respective orbits which align with the curvature of the Sun's Magnetic and Electrical Lines of Force. The Sun's Lines of Force are also warped by the spinning of the Sun, but this does not alter how the magnetic and electrical fields align with one another!

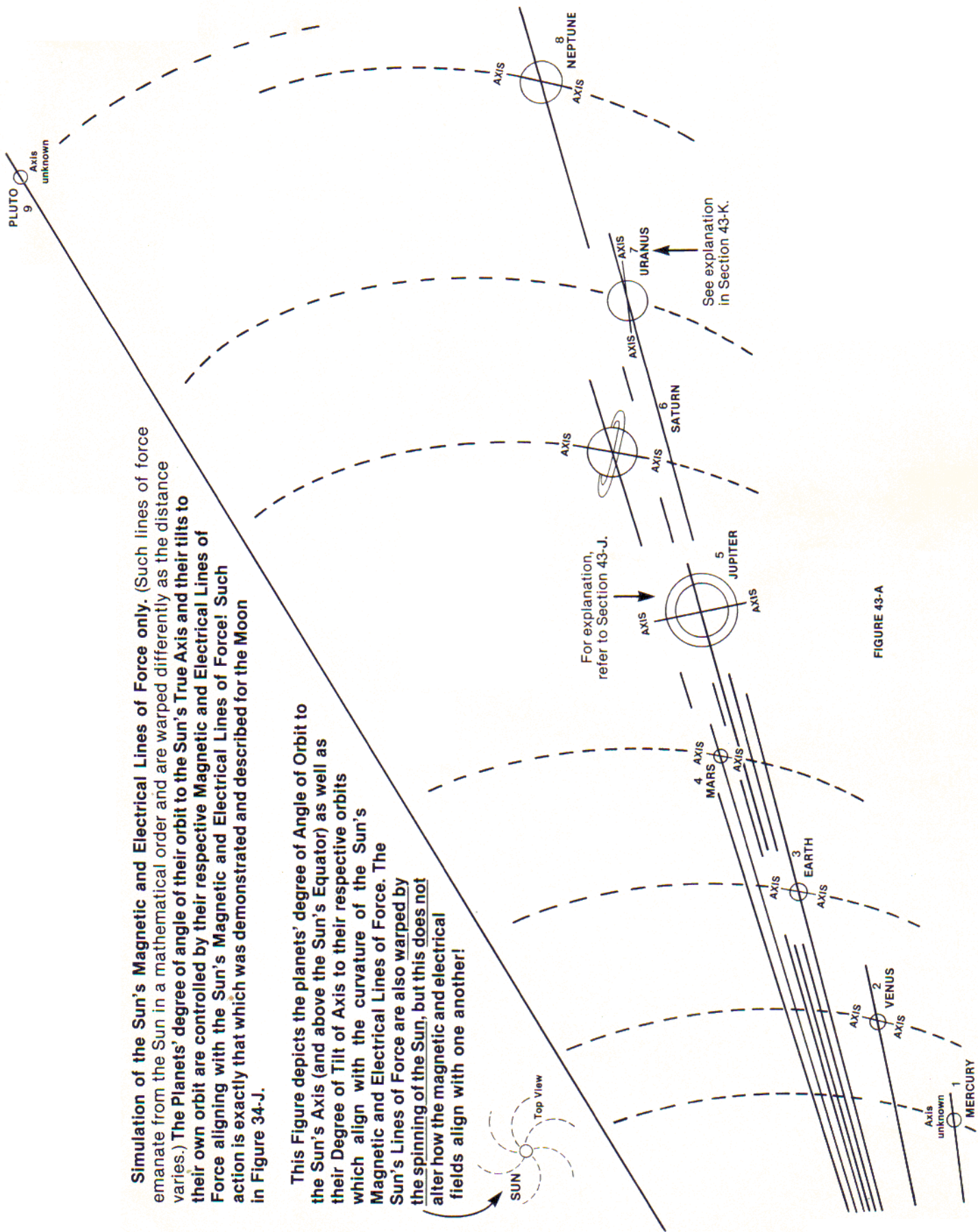

FIGURE 43-A

why they are seldom found more than 40° North or South of the equator. Like the small magnet in experiment 42-A, the sunspots are probably pulled under the Sun's surface if they travel too close to the magnetic poles of the Sun.

**43. A.** Astronomy teaches that seven of the planets orbiting the Sun have particular tilts to the perpendicular of their orbits, and two of the planets' tilts are unknown. (See Figure 43-A.)

The tilts of the planets and their distances from the Sun are as follows:

1. **MERCURY, tilt unknown**  
36 million miles from the Sun
2. **VENUS, tilt 25°**  
67 million miles from the Sun
3. **EARTH, tilt 23½°**  
93 million miles from the Sun
4. **MARS, tilt 25°**  
142 million miles from the Sun
5. **JUPITER, tilt 3°**  
484 million miles from the Sun
6. **SATURN, tilt 27°**  
887 million miles from the Sun
7. **URANUS, tilt 82°**  
1,787 million miles from the Sun
8. **NEPTUNE, tilt 29°**  
2,797 million miles from the Sun
9. **PLUTO, tilt unknown**  
3,670 million miles from the Sun

**43 B.** No reason is provided by currently accepted teaching which explains the above statistics other than the statement that "it just exists this way."

**43 C.** All the proof that I have presented to this point indicates to me that all planetary motion in our Solar System is controlled by the Sun's magnetic and electrical fields of force.

**43 D.** Figure 43-A and the earlier Figure 34-J represent additional proof that planetary motion is controlled by the Sun's magnetic and electrical fields of force.

**43 E.** In Figure 43-A, the nine planets are shown in their particular orbits with their respective degree of axis tilt to their orbit.

**43 F.** In Figure 43-A, the dash lines are intended to simulate the curvature of the Sun's magnetic and electrical lines of force.

**43 G.** Because there is progressively a greater difference of millions of miles between each planet (refer to Section 43-A), the curvature of the Sun's lines of force will have greater and greater arcs.

**43 H.** It is obvious that each of the following planets — Venus, Earth, Mars, Saturn, and Neptune — is aligning its true axis (which is the result of its magnetic axis) to the curvature of the Sun's magnetic and electrical lines of force. (See Figure 43-A.)

**43 I.** It is also obvious that the degree of planetary axis tilt becomes progressively greater as the distance from the Sun becomes greater. Venus is an exception and therefore deserves verification due to its continuous cloud covering. Jupiter is an exception and is discussed next.

**43 J.** Jupiter is so voluminous — it could accommodate all the other planets within its perimeter — and has such a powerful magnetic and electrical field of force, that it nearly cuts the curvature of the Sun's lines of force into a straight line. (See Figure 43-J1.)

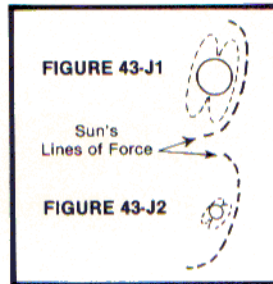

The average distance of Jupiter's most remote satellites is 23,660,000 miles. Therefore, the tilt of Jupiter's axis to the perpendicular of its orbit is only 3 degrees. A smaller electromagnetic field would cause Jupiter to tilt more, as it does with the smaller planets. (See Figure 43-J2.)

**43 K.** Uranus is diamagnetic in nature and aligns perpendicular to the Sun's magnetic and electrical lines of force. (The nature of diamagnetic materials was originally proven by Michael Faraday.)

**43 L.** Astronomy teaches that all of the planets are above the Sun's equator on one side of their respective orbits and below the Sun's equator on the other side of their respective orbits.

**43 M.** There is no reason provided in current astronomy teachings except to say that "it just exists this way."

---

***"... all planetary motion in our Solar System is controlled by the Sun's magnetic and electrical fields of force."***

---

**43 N.** Figure 43-A shows the planets *above* the Sun's equator; the planets hold their same tilts when they travel to the other side of the Sun, but are then *below* the Sun's equator.

**43 O.** The reason for such "tilt maintenance" is the same reason provided for the Moon's tilt in its orbital relation to the Earth's equator. (See Figure 34-J.)

**43 P.** Examine my Theory of the Universe as I stated in Section 33-D. If you consider all the factual information that I have presented throughout this entire Book, *the Facts verify my Theory!*

<sup>43</sup> **Q.** The Facts I have consistently presented are certainly more scientifically sound than current astronomical teachings which say that "all bodies in the Universe have particular angles, orbits, and distances from one another simply because they 'landed' that way." At one time, gravity was called an "invisible entity" which was not clearly understood. It should be clear by now that gravity simply represents the "Unequaling Effect" of the Unobvious Electromagnetic (gyroscopic-action-entity) composition of all Matter.

<sup>43</sup> **R.** The following information should be taken seriously and "Mastered":

**44. A.** I am extremely indebted to Dr. Robert E. Smith, Chief, Orbital and Space Environment Branch, Marshall Space Flight Center, Alabama, for having the scientific insight to recognize a correlation between my work and the work accomplished by Ellsworth Huntington over fifty years ago.

<sup>44</sup> **B.** On June 22, 1976 (see Section 33-A), Dr. Smith sent copies of Ellsworth Huntington's work to me with the comment that "it supplements and complements your work."

<sup>44</sup> **C.** Without Dr. Smith's scientific insight, I am very doubtful that I would have ever known of this information since it appears that Ellsworth Huntington's work can only be obtained from the Library of Congress.

<sup>44</sup> **D.** After reading Huntington's work, I was amazed that it had lain dormant for all these years (except for the recognition of its significance by such insightful individuals as Dr. Smith), and I was very excited because the reader will see that Ellsworth Huntington's work complements my work *exactly*. However, after pondering the results of my and Huntington's work, as well as conducting additional experiments, the scientific results I have obtained give me reason to have concern since it appears that a possible catastrophe may lie in the Earth's immediate future. [*But I must stress that there is no problem which cannot be solved if the essence of the problem is properly understood!*]

<sup>44</sup> **E.** The dedicated scientific work of Ellsworth Huntington *proves* that sunspot activity is principally caused by the planets. The question asked by Huntington was whether such sunspot activity was caused by a gravitational, electrical, or some other effect. Huntington believed that it was probably an electrical effect. (See pages 244, 245, and 284 of *Earth and Sun* by Ellsworth Huntington.)

<sup>44</sup> **F.** I will proceed to combine Huntington's scientific findings with mine: Sections 33 through 43-P of this Book provide exacting, scientific evidence that the

planets' tilts and orbits are governed by electromagnetic fields of force.

<sup>44</sup> **G.** On the bottom of page 244 and the top of page 245 of *Earth and Sun*, Huntington states that sometimes the planets have a negative effect upon sunspot activity and at other times a positive effect. This was very perplexing to Huntington since there was no way such results could be explained by a gravitational effect. But such sunspot effects may be explained by an electrical hypothesis.

<sup>44</sup> **H.** In accord with such an electrical hypothesis, I conducted the following experiment:

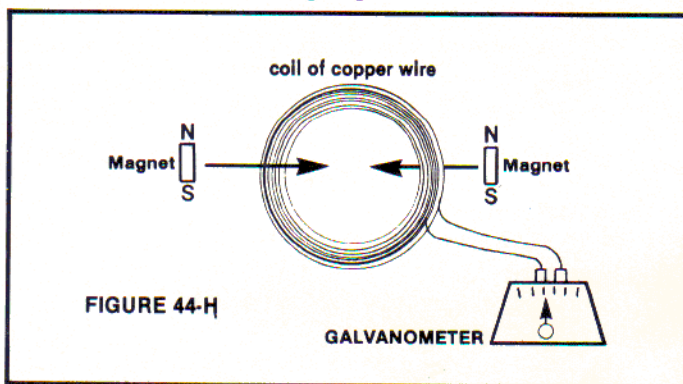

FIGURE 44-H

<sup>44-H</sup> (1) If the magnets were singly moved, a given current was recorded on the galvanometer.

<sup>44-H</sup> (2) A considerably smaller current was recorded on the galvanometer when the magnets were moved simultaneously at the same speed in different directions as shown in Figure 44-H. (Current is now being induced in two different directions and tends to cancel the net effect.)

<sup>44-H</sup> (3) This simple experiment satisfies Huntington's concern re sunspots described in Section 44-G, since this concern can be duplicated with the Laws of Electromagnetic Induction.

<sup>44</sup> **I.** Throughout his book *Earth and Sun*, Huntington indicates that when the planets of our Solar System are in alignment with one another, they increase the quantity of sunspots. As a result of this observation, I conducted the following experiment:

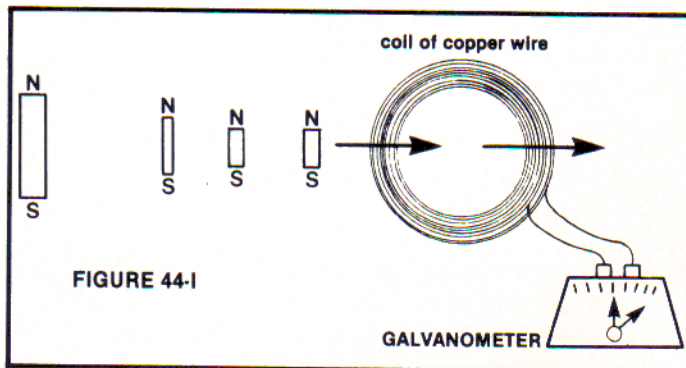

FIGURE 44-I

44-1 (1) The greater the number of magnets aligned as shown in Figure 44-I, the greater the amount of current that was recorded on the galvanometer when the magnets were moved as shown. When the magnets reached the second arrow and continued on, the current reversed.

44-1 (2) If the largest magnet moved alone, then less current was generated than if one additional magnet was moved in alignment with it.

44-1 (3) This experiment satisfies Huntington's observation in Section 44-I since that observation is also duplicated by the Laws of Electromagnetic Induction.

44 J. On pages 278-281 of *Earth and Sun*, Huntington states that another observed relationship which puzzled him was that sunspot activity varied as a planet was North or South of the Sun's equator. This observation is also explained by my experiments in Section 44-H and 44-I. Every time the direction of movement or polarity direction changes, an electromagnetic induction change can be expected in accordance with the Laws of Electromagnetic Induction. (See Section 44-M.)

44 K. On page 225, bottom of page 245, and pages 246 and 247 of *Earth and Sun*, Huntington indicates that there is a relationship of sunspot activity to a planet's eccentricity of orbit.

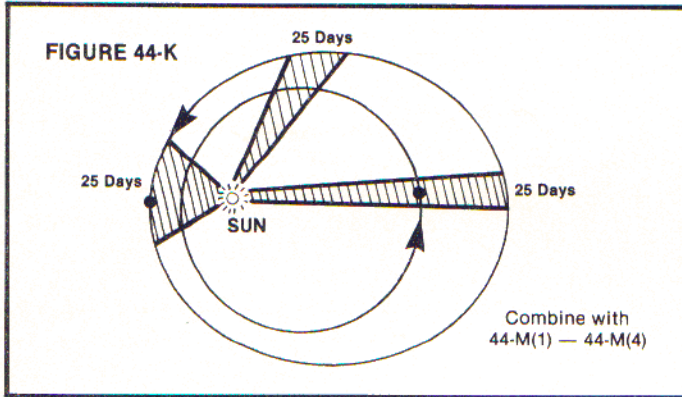

44-K (1) I then simply applied Kepler's Second Law of Planetary Motion which states that "the radius vector would cover equal areas in equal time."

44-K (2) Consequently, the difference in the rate of speed of orbit velocity for all the planets varies continuously. (See Figure 44-K.)

44-K (3) In accordance with the Laws of Electromagnetic Induction, a continuous change in induction can be expected.

44-K (4) However, remember that both the direction of movement and polarity being moved through are pertinent in terms of whether the change is

in harmony (giving a total increase in sunspots) or not in harmony (tending to cancel out sunspots). [Refer to my experiment in Sections 44-H, 44-I, and Figure 44-M.]

44 L. The average sunspot cycle is 11.13 years. However, as Huntington states in *Earth and Sun*, (page 253), sunspot maxima had ranged from 7.3 to 17.1 years.

44 M. With respect to the Laws of Electromagnetic Induction, it is an intriguing test of logic to anticipate the resulting force (or effect) of a planet (and its accompanying electromagnetic field) moving through the Sun's electromagnetic field in a complicated manner.

44-M (1) The planet moves in an opposite direction through the Sun's electromagnetic field when the planet is on one side of the Sun in contrast to when the planet is on the other side of the Sun.

44-M (2) While on one side of the Sun, the planet moves down from the North pole to the South pole. On the other side of the Sun, the planet moves up from the South pole to the North pole. In both cases, the planet goes into opposite sunspot polarity each time this occurs! The Sun rotates every 28 days sweeping this changing induction effect into the Earth and the other planets.

44-M (3) The planet also changes its speed through the Sun's electromagnetic field when the planet is at its farthest and closest points from the Sun.

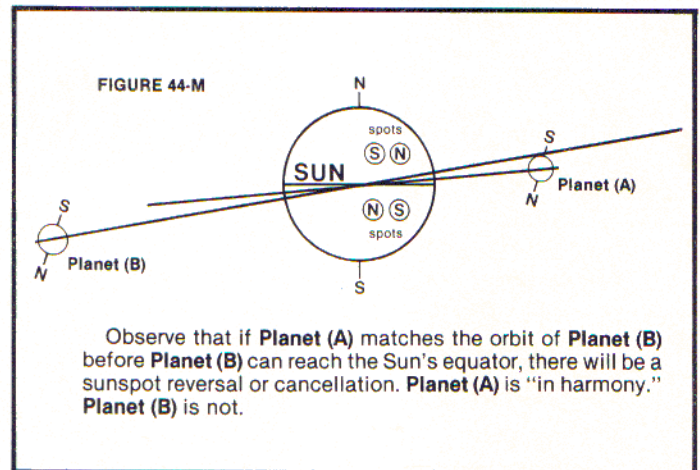

44-M (4) Each planet crosses the Sun's equator twice and reaches two different extreme distances from the Sun during one planetary orbit of the Sun. (See Figure 44-M.)

Therefore, considering Section 44-K (4) and Section 44-M (1)-(3) and then applying the electromagnetic induction effect, one would consider these four points [44-M (1)-(4)] the most important for determining the average net effect.

<sup>44</sup>  
**N.** On the bottom of page 283 of *Earth and Sun*, Huntington states that he is not implying that the energy emitted from sunspots is derived from the planets, but that the planets act as a catalyst to cause the release of energy that is continuously present in the Sun, *i.e.*, similar to a "trigger mechanism" used in an explosion.

<sup>44-N</sup>  
 (1) I agree with this statement completely.

<sup>44-N</sup>  
 (2) **The Sun is Matter (electromagnetic energy), and the Matter is continuously converted into electromagnetic energy of one form or another. When triggered by electromagnetic induction, the Sun apparently accelerates its conversion of Matter into electromagnetic energy. (See Figure 44-O.)**

<sup>44-N</sup>  
 (3) **The sunspots and planets are behaving in accordance with the known Laws of Electromagnetic Induction.**

<sup>44-N</sup>  
 (4) **Sunspot reversal is caused by the sum of the total effect of all the planets in terms of whether the resultant, dominating, electromagnetic induction force is above or below the Sun's equator. As the planets continuously vary in their alignment, it is obvious that the resultant, dominating, electromagnetic induction force will also vary as it occurs throughout the observed sunspot cycle.**

<sup>44</sup>  
**O.** Observe Figures 44-Oa and 44-Ob which are depicted below:

<sup>44-O</sup>  
 (1) **In Figure 44-Oa, the electromagnetic output of the Sun appears orderly.**

<sup>44-O</sup>  
 (2) **In Figure 44-Ob, the electromagnetic output of the Sun appears explosive and, therefore, potentially hazardous with corresponding effects in-**

**duced into the orbiting planets. Imagine this effect greatly increased.**

<sup>44-O</sup>  
 (3) **QUESTION: What results can be expected when all the planets from Saturn to the Sun become perfectly aligned while at their closest respective points to the Sun?**

<sup>44-O</sup>  
 (4) **Present scientific evidence indicates that, in the past, the Earth's magnetic field has reversed and has been located in other areas. Moreover, there is also evidence that the true axis has also been located at other points upon the Earth.**  
**QUESTION: What event(s) caused these changes?**

<sup>44-O</sup>  
 (5) **All the evidence I have gathered indicates that if the Earth's magnetic field reversed, the Earth would then try to turn upside-down to again align with the Sun's field. Such an event would cause earthquakes, volcanic eruptions, tidal waves, and atmospheric storms that would be disastrous to most life on Earth. Even lesser stresses placed upon the Earth can be dangerous.**

<sup>44</sup>  
**P.** *As the planets affect the Sun (and the Sun affects the planets), so does the Sun and other stars in our Galaxy affect the energy force around which they orbit!* Moreover, this central galactic energy source also affects the Sun and other stars in our Galaxy. Fortunately, because there are so many stars in our Galaxy, the mathematical odds against a dangerous stellar alignment are in our favor. **However, the evidence presented does warrant an immediate and extensive investigation to ensure that such an alignment will not surprise us!** The Universe does not "owe" us an advance warning of such potentially catastrophic stellar alignment. It is up to us to use our intellectual abilities to determine accurately if such a threat may exist and to take appropriate measures to ensure the durable survival of our Species.

FIGURE 44-Oa

FIGURE 44-Ob

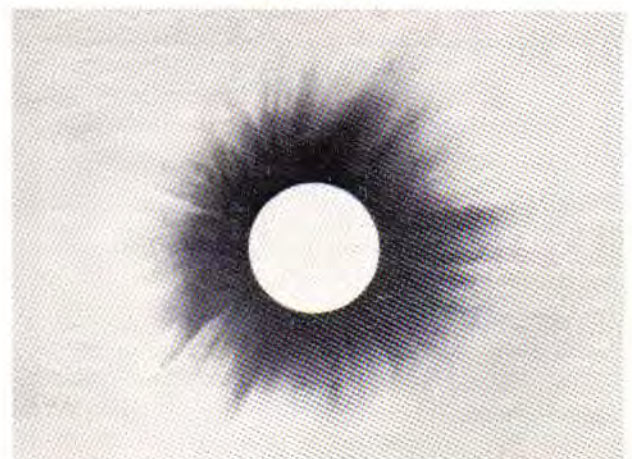
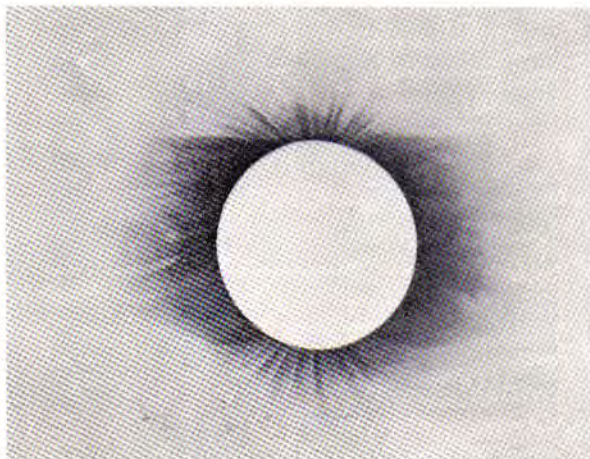

1. Corona, May 18, 1901, near time of minimum sunspot activity. Characteristic sunspot minimum with short polar brushes and long equatorial streamers.

2. Corona, Aug. 30, 1905, near time of maximum sunspot activity. The circular corona characteristic of a sunspot-maximum period and the long equatorial streamers which give it its typical form are here visible.



45. The result of the Pioneer 10 passage by Jupiter is stated to have shown that the polarity of Jupiter's magnetic field in relation to axis spin is opposite to that of Earth's.

45  
A. I strongly challenge this statement. Jupiter has 13 orbiting moons, and their magnetic poles will be opposite to Jupiter's and to the Earth's.

45  
B. The orbital period of these moons varies from 12 hours to 2 years. The four largest moons (which rival Mercury and Mars in size), all orbit Jupiter in a short period of time:

Jupiter's Moon	Orbit Time	Average Distance From Jupiter
IO	1.7691 days	422,000 miles
EUROPA	3.5512 days	671,000 miles
GANYMEDE	7.1546 days	1,100,000 miles
CALLISTO	16.6890 days	1,880,000 miles

45  
C. Other results of the Pioneer 10 voyage state that the planet Jupiter generates a powerful and complex magnetic field.

45  
D. Jupiter's magnetic field is complex since all of its moons have magnetic fields which are the reverse of Jupiter's magnetic field. These reverse lunar magnetic

tions. For example, both probes encountered gusts of electrons of Jovian origin which were as much as 140 million miles from the planet. Jupiter generates a powerful magnetic field which occasionally accelerates particles to almost the speed of light and then "squirts" such particles great distances into the inner solar system. [My comparison: This same effect is observed from solar flares associated with sunspots, except greatly multiplied.]

45  
H. The electromagnetic induction effect of the moons upon Jupiter is further evidenced by the fact that spots appear and disappear on Jupiter's surface in the space of a few days or months. [My comparison: This same description describes sunspots appearing and disappearing.]

45  
I. Jupiter's Red Spot also shows a variance. It varies in color from an intense brick-red to a faint grey. At times it has lost all color and has become invisible. It is very likely that electromagnetic induction from Jupiter's moons also affects the Red Spot.

45  
J. Other results from Pioneer 10 and 11 state that Jupiter is enveloped in a huge, quivering magnetic bubble at least ten million miles in diameter. The total magnetic force or movement of its magnetosphere has been estimated to be about 20,000 times that of Earth's.

---

***"Jupiter's magnetic field is even more complex because its moons have a similar electromagnetic induction effect upon Jupiter as (I have shown) the planets have upon the Sun."***

---

fields were encountered during the passage of Pioneer 10 as evidenced by the findings of Section 45-E below.

45  
E. As Pioneer 10 and 11 crossed the orbits of the major Jovian moons, their equipment detected an interesting phenomenon: there was a distinct drop in particle flux at each orbital crossing. It appears that the large satellites literally "carve holes" in the trapped radiation belts by absorbing large quantities of radiation during every ten-hour rotation of Jupiter and of Jupiter's field lines on which the particles mirror back and forth. It is obvious to me and it should be obvious to the reader that such results are caused by the electromagnetic field of the moons of Jupiter which trap or repel this radiation.

45  
F. Jupiter's magnetic field is even more complex because its moons have a similar electromagnetic induction effect upon Jupiter as (I have shown) the planets have upon the Sun.

45  
G. Such an electromagnetic induction effect is evidenced by the statement that Pioneer 10 and 11 made findings that have raised new and baffling ques-

45  
K. Considering FACT 45-J, it would be a complete violation of the proven Laws of Electromagnetic Induction for Jupiter's magnetic field polarity to be the reverse of Earth's. I have presented sound scientific evidence that Jupiter (as well as the other planets) has an electromagnetic field which merges with the Sun's and that all planets will take the path of least resistance. Such a path would be one which is aligned with the Sun's field and not one which generates opposing fields of force. Because of the great diameter of Jupiter's electromagnetic field, there would be a torque placed at both ends of Jupiter's axis that should be phenomenal. Such a force would cause Jupiter to turn upside-down or move away from the Sun. Jupiter behaves like a gyroscope, and with such a force imposed upon its axis it would most certainly move at right angles to that force. Each time that Jupiter travels from the North of the Sun's equator to the South of the Sun's equator, the torque would be applied differently. I have absolutely no doubt that I am correct and that Jupiter's electromagnetic field has the same polarity as Earth's relative to axial spin; moreover, the magnetic axis of Jupiter and the magnetic axis of the Earth are opposite to the magnetic axis of the Sun!

46. Considering the scientific findings that I have presented which indicate that the planets affect an electromagnetic induction force into the Sun, it should be obvious that *the reverse is also true, i.e.*, the triggering of the release of energy in sunspots also have an electromagnetic induction force into the planets. [I remind the reader of Newton's Third Law of Motion: "To every action there is always opposed an equal reaction: or, the mutual actions of two bodies upon each other are always equal, and directed to contrary parts."]

46  
A. Consequently, the weather on all the planets is certainly influenced by sunspot activity.

46  
B. Reference Section 49-I concerning the "Devil's Sea," "Bermuda Triangle," and other such geographi-

---

***"... the triggering of the release of energy in sunspots also have an electromagnetic induction force into the planets."***

---

cal areas: I postulate that such areas are subjected to electromagnetic lines of force which leave the Earth's surface at those areas and travel to the region where the Earth's general electromagnetic field merges with the Sun's electromagnetic field.

46  
C. My hypothesis brings to mind the finding that "loops" of magnetic lines of force have been detected leaving the Sun's surface and traveling into Space. *You will note that the drawing depicted in Section 49-I matches the description provided here concerning the Sun. Such lines of force are traveling to the same point in our Galaxy's magnetic field.*

46  
D. Therefore, the weather is probably affected (to some degree) if, because of the electromagnetic induction effect, the planets are struck by these "loops" as the Sun rotates.

46  
E. To those scientists who have had the insight to recognize a relation between sunspot activity and the Earth's weather — and who have endeavored to convince "closed minds" of this fact — all of my combined findings are scientific proof that your convictions are correct.

47. Dr. Robert Smith recommended that my hypothesis should be capable of explaining the years 1645-1715 (Maunder Minimum) when there was little or no sunspot activity. [For further information on this subject, see the article entitled "When The Sun Went Strangely Quiet," pages 154-156 in the March 6, 1976 issue of *Science News*.]

47  
A. Previous findings have demonstrated that the triggering of sunspot activity is principally influenced by the planets.

47  
B. The evidence indicates that the planets act as a triggering mechanism that accelerates the conversion of the Sun's Matter into electromagnetic energy.

47  
C. Therefore, when the planets do not trigger sunspot activity, this would indicate that the Sun's total Matter conversion processes had weakened.

47  
D. The question one should ask is: "Why is the Sun's total Matter conversion into electromagnetic energy a *variable* and not a *constant* process?"

47  
E. There is a possibility that the planet's electromagnetic fields decreased in strength and consequently reduced their electromagnetic induction strength into the Sun. However, I suspect other causes.

47  
F. There is also the possibility that the satellites of Jupiter and Saturn (all of which have electromagnetic polarity opposite to all the planets) become aligned, thereby reducing the electromagnetic effects of the planets. However, I suspect other causes, since these satellites remain aligned for only a short time.

48. Consider the negative and positive effects that the planets have in triggering the induction of sunspot activity. **It then seems logical that star alignment would have an even greater negative and positive effect upon the total processes of the Sun!**

48  
A. It is estimated that it takes 200 million years for the Sun to make one orbit of our Galaxy. There are also an estimated 100 billion other stars orbiting our Galaxy — some requiring longer and others a shorter period of time to make one orbit of our Galaxy. As a result, many conjunctions of other stars and the central force of our Galaxy will occur.

48  
B. Re-examine Figure 38-A. It should become obvious that the Sun — in its orbit around the central force of our Galaxy — will come into conjunction with many other stars as well as the central force. It is also

---

***"... varying star alignments will induce some type of sunspot activity in the central force of our Galaxy."***

---

obvious that these conjunctions will vary greatly in terms of the number of stars in conjunction *at any one time*. Considering the previous findings which I have presented in this Book, it should be apparent that these varying star alignments will induce some type of sunspot activity in the central force of our Galaxy. The electromagnetic output of this central force will vary according to such varying star alignments, and such varying output will affect the Sun's rate of total conversion of Matter into electromagnetic energy.

<sup>48</sup>  
C. Our Sun and other stars will be above or below the equator of the central force of our Galaxy, and the polarity of sunspot-type activity within this central force will reverse as it does within our Sun. There will be times when our Sun is in electromagnetic harmony with this sunspot-type activity of the central force of our Galaxy, and there will be other times when our Sun is not in electromagnetic harmony. (Refer to

---

***“This harmonic variance will affect the total conversion of the Sun’s Matter into electromagnetic energy.”***

---

Figures 38-A and 44-M.) This harmonic variance will affect the total conversion of the Sun’s Matter into electromagnetic energy. [Such an effect is similar to how sunspot activity affects the Earth’s meteorology, earthquakes, and the “Devil’s Sea”/“Bermuda Triangle” areas; I will discuss these two geographical areas in Section 49. By combining the information in Sections 46-C and 49-I, I will demonstrate a correlation of electromagnetic loops for these areas and electromagnetic loops of the Sun.]

<sup>48</sup>  
D. The above findings provide a scientific explanation for large solar flares which occur when sunspot activity is at a minimum. Because sunspot-type activity of the central force of our Galaxy affects the electromagnetic loops of the Sun (as I have already explained for the Earth), such activity will also affect the conversion in certain areas of the Sun’s Matter into electromagnetic energy.

<sup>48</sup>  
E. **Because of stellar alignment within our Galaxy**, there have been periods of time when the total conversion processes of the Sun were weakened to the point that the planets did not trigger sunspot activity, *i.e.*, the Maunder minimum. Considering this point, it should be logical that *the reverse will also be true*. [In addition, one must *also consider* inter-galactic alignment with respect to the Central Entity which galaxies orbit. See Section 52-M.)

<sup>48</sup>  
F. **Because of stellar alignment within our Galaxy**, there will be periods of time when the total conversion processes of the Sun will be strengthened to the point that the planets will trigger sunspot activity of greater intensity than any for which we have records. Remember, the distances the stars travel in their particular orbits are immense. It may require thousands or even millions of years to achieve a particular stellar alignment which would directly affect our Sun. I am convinced that just as the planets affect the Sun (and vice versa), so do the stars in our Galaxy affect the central force of our Galaxy (and vice versa) and so the Galaxies affect the Central Entity which *they* orbit (and vice versa).

<sup>48</sup>  
G. The scientific facts of history verify that in the past the Earth has experienced extreme catastrophes. It is a reasonable prediction that such catastrophes will be experienced in the future unless we can prevent such catastrophes via a “Mastering” of the essential nature of astronomical activity. Simply because the human species exists upon the planet does not “automatically immunize us” from further catastrophe.

<sup>48</sup>  
H. *However, I have absolutely no doubt that there is a logical solution to whatever problems we may encounter in the future!* Do not listen to “doomsayers” who “spout” only negative statements. Such individuals cannot speak for the *creativity of others who are willing to face any problem “head on” and solve it!*

<sup>48</sup>  
I. Earlier in this Book, I have shown the reader a new source of unlimited power. Those thinking individuals who have “Mastered” what I have taught can accomplish any task. Conducting grids can be constructed in Space which will encompass the entire Earth. As a result, *electromagnetic fields of any intensity can be released to neutralize or harmonize with incoming electromagnetic induction from Space. With such construction the Earth’s weather can be controlled, created, and directed!*

<sup>48</sup>  
J. If the scientific community assumes a firm stand and presents exacting scientific evidence that convinces the general public to take the necessary action capable of saving life and property, then this will be one of the most beneficial and predicted events in the history of science for inducing the general public to rally 100% behind the efforts of scientists. [Certain geographical areas of the Earth may be advantageous for conducting scientific experiments.]

---

***“Electromagnetic fields of any intensity can be released to neutralize or harmonize with incoming electromagnetic induction from Space. With such construction the Earth’s weather can be controlled, created, and directed!”***

---

<sup>48</sup>  
K. For additional, factual, and independent verification of the sunspot/earthquake connection and explanation which I have presented in this Book, refer to the article entitled “Seismicity in sync with the sun?” in the April 27, 1985 issue of *Science News*. While the article discusses a correlation between sunspot activity and Parkfield, CA earthquakes, neither the article’s author nor the scientific community present an explanation for such correlation as I have done in this Book even before this fact.

## 49. The Bermuda Triangle

The following information was presented by the New Jersey Society for the Investigation of the Unexplained, founded by scientist Ivan Sanderson and consisting of mathematicians, geographers, geodists, electromagnetic engineers, and others:

49

**A.** During World War II, both Japanese and U.S. Military planes plotted the Devil's Sea. Its size and pitch are similar to the Bermuda Triangle!

49

**B.** It was also found that there appear to be unexplained happenings which occur within ten, equally spaced areas on Earth. Such areas are spaced at exactly 72-degree intervals — five areas in the Northern Hemisphere and five areas in the Southern Hemisphere.

49

**C.** I found the above information quite thought-provoking! Such areas are not located more than 40° North or South of the Earth's equator and they appear to have an alignment of the Northern Hemisphere areas with the Southern Hemisphere areas. I could see that such geographical positioning coincided with the known scientific facts concerned with the positioning of sunspots upon the Sun. (Such sunspot positioning was discussed in Section 36-B.)

49

**D.** I also found it very interesting that there are two places on the Earth where the compass needle points to true North and not to magnetic North. One of these places is in the area of the Bermuda Triangle and the other is in the area of the Devil's Sea. In addition, compass needles have been known to continually spin in these areas.

49

**E.** I also find it interesting that a large percentage of unexplained happenings occur in June/July and December/January.

49

**F.** These two periods represent the time of the year when the Earth is farthest or closest to the Sun and when the Earth makes a sharper curve through the Sun's electromagnetic field.

49

**G.** This Book has already presented exacting scientific evidence for the relationship between the Earth's true and magnetic axes.

49

**H.** Combining all of my previous scientific findings with the above information, I made the following hypothesis:

49

**I.** I have hypothesized that at certain times the Bermuda Triangle, Devil's Sea, and probably several other areas on Earth (in each Hemisphere) have electromagnetic lines of force (consisting of gyroscopic particles/kinetic energy) which leave the Earth's surface *at these geographical areas* and extend into

Space at a region where the Earth's general electromagnetic field merges with the Sun's electromagnetic field. Specific regions upon the Earth's surface such as the Bermuda Triangle, etc., behave differently from the remainder of the Earth's surface in which the electromagnetic lines of force extend towards the North and South electromagnetic poles. (See Figure 49-I and Section 46-C.)

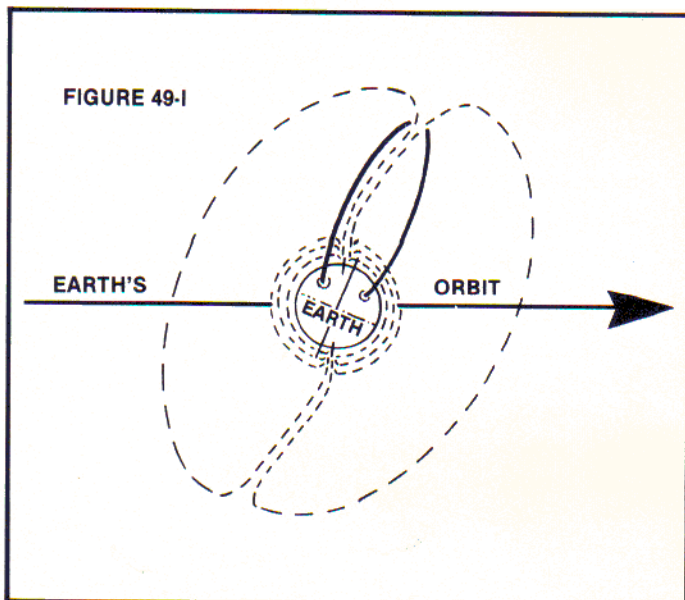

49

**J.** Such a hypothesis would account for electromagnetic conditions which occur in certain areas while the balance of the Earth's surface is not noticeably affected. Realizing the similarities of these unusual areas upon Earth to the sunspot areas on the Sun, I concluded that there should be a connection between sunspot activity and electromagnetic induction into those particular areas on Earth.

49

**K.** The greatest noticeable effect in these areas should be when sunspot activity is either decreasing or increasing. This would be true because as an electric current increases or decreases in a wire coil, the current creates an expanding and collapsing magnetic field and thus induces another current into a separate conducting coil of wire.

49

**L.** If the reports regarding the Bermuda Triangle and the Devil's Sea are true, then it is apparent to me that these areas can possibly be the greatest "natural" scientific laboratories on Earth for learning more about the nature of electromagnetic energy. Matter may well be formed or converted into Energy in these areas.

49

**M.** Any scientific experimentation in these areas should be conducted wisely. It is obvious that electromagnetic occurrences do not happen all the time and that they vary in intensity. It is also very likely that a human being would be in grave danger if Matter is strongly affected during periods of peak electromagnetic activity.

49  
**N.** With a history of confusion and abnormal claims surrounding the Bermuda Triangle, one is tempted to dismiss the subject and reject the need for further investigation. However, one should not adopt such a close-minded attitude. I recommend reading the *Handbook of Unusual Natural Phenomena* by William R. Corliss. In this book, one will find over 500 pages of recorded, unusual phenomena and anomalies. If your mind is open to new considerations, you will observe that the common denominator of these documented facts of nature is an "electromagnetic effect."

Throughout the history of science, it has often been the *anomalies in nature* which have provided "fertile soil" for new discoveries and such anomalies have often been a source of curiosity stimulation to enhance our understanding of the Universe.

***"This basic gyroscopic-action-entity prevails throughout our entire Universe and, in a mechanical sense, it electromagnetically couples the Universe into a single entity or universal energy machine!"***

50. All natural motion (of planets, asteroids, stars, galaxies, etc.) in the Universe is the result of the movement of the basic gyroscopic-action-entity which comprises all Matter. *This basic gyroscopic-action-entity prevails throughout our entire Universe and, in a mechanical sense, this gyroscopic-action-entity electromagnetically couples the Universe into a single entity or "universal energy machine"!*

The basic gyroscopic-action-entity comprises all Matter: from the atom to the molecule to the everyday materials which surround us.

50  
**A.** Examine the schematic diagram of our Galaxy taken from the book *Astronomy* by Fred Hoyle. However, study Figure 50-A in view of the material I have taught you.

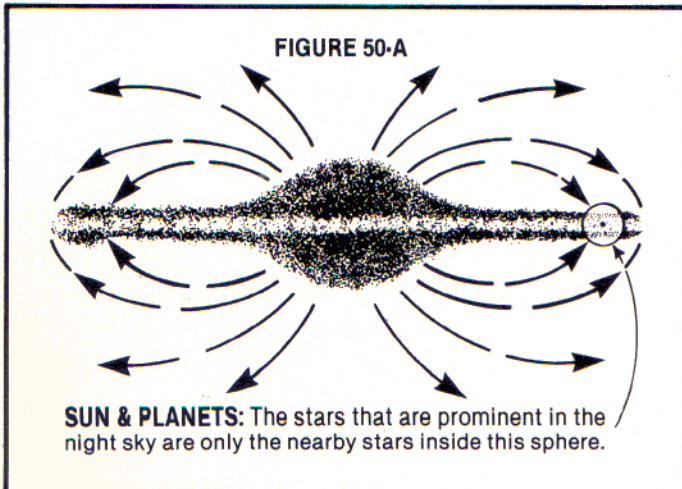

50-A  
**(1)** Well over 100 years ago, Michael Faraday proved that neutrality to a magnetic field does not exist.

50-A  
**(2)** I have taught and mechanically explained the "oneness" of the mechanical essence (i.e., gyroscopic-action-entity) of Gravity, Electric Charge, Magnetism, Inertia, Matter, Light, Heat, Quantum Mechanics, and Universal Motion.

50  
**B. QUESTION:** Do I have to teach you more? The answer is probably "yes" for those who have been unjustly taught to memorize statements presently taught in Astronomy.

51. **EXAMPLE:** Presently, it is debated as to whether or not the Universe is contracting or expanding. Based upon Red Shift observations, it is generally agreed that the galaxies are receding in a straight line.

51  
**A.** However, I do not consider this exacting scientific evidence. Example: (See Figure 51-A.)

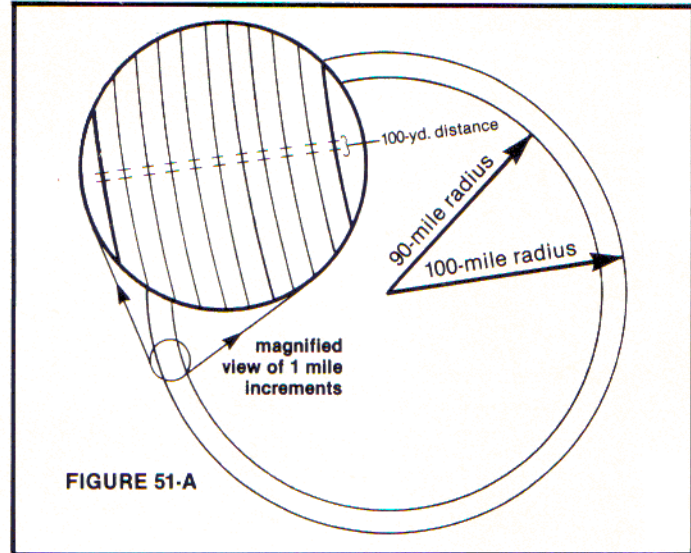

Draw ten concentric circles in which each circle's radius is one mile shorter than the next, i.e., the largest circle with a 100-mile radius and the smallest circle with a 91-mile radius. On the perimeter of each concentric circle, measure a 100-yard distance from a point on which to start running a race. If one considers only those 100 yards on each circle with one man running in each lane, it would appear that the ten men would all be running in straight lines for the brief period of their 100-yard race. If they continued to run, they would appear to recede from the viewer in a straight line if the viewer only occasionally checked their positions.

51  
**B.** The distances of the elliptical orbits of the galaxies are such that even a distance of 100 million miles could be considered at any one moment on those orbits and it would appear that the galaxies were all receding in a straight line.

51  
**C.** I remind the reader that the true speeds of galaxies are not presently known. Their speed is relative to an observer on Earth who is in a most difficult position for recording exact astronomical measurements. A point on the Earth's equator rotates at 1,050 miles per hour, the Earth revolves around the Sun at 1,100 miles per minute, and the Sun moves throughout our Galaxy at 150 miles per second. In addition, our Galaxy is moving at a speed in its orbit that is different from other orbiting galaxies. How would you like to attempt to record exact measurements for the ten runners described in Section 51-A while you are spinning upon a complex mechanical apparatus which has the same motions that the Earth, Sun, and Galaxy have at fast speeds? (See Figure 51-C.) [The reader may find it of interest that in 1967 I taught the difficulty of recording observations under such conditions of complex motion via a Document which I sent to fifty-six major universities.]

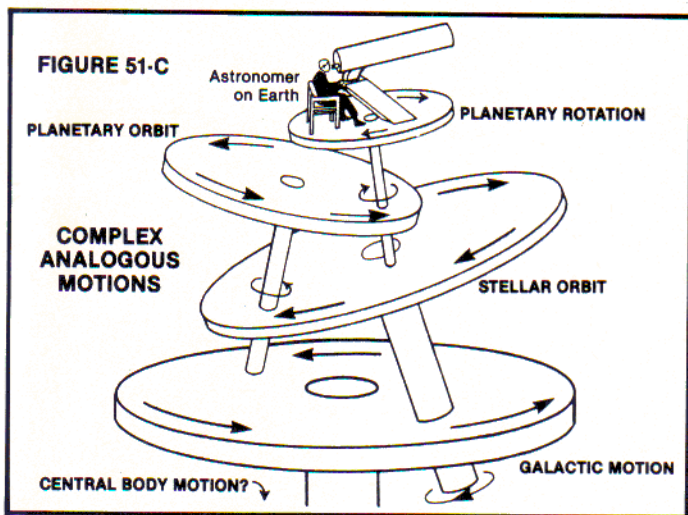

51  
**D.** Considering these complex astronomical motions combined with my previous scientific findings, I stand with my Theory (teachings) stated in Section 33-D which I repeat:

51  
**E.** It is my Theory (teachings) that a central electromagnetic field completely pervades our Galaxy's electromagnetic field and causes our Galaxy to align with and orbit it. Moreover, our Galaxy's electromagnetic field causes the Sun to align with and orbit within our Galaxy, since the Galaxy's field pervades the Sun's electromagnetic field. The Sun's electromagnetic field causes all the planets in our Solar System to align with and orbit the Sun since the Sun's electromagnetic field pervades all of its planets and *their* respective electromagnetic fields. The Earth's electromagnetic field pervades the Moon's electromagnetic field and causes the Moon to align with and orbit the Earth, just as the electromagnetic fields of the other planets pervade the electromagnetic fields of their respective moons.

Thus one has a "graded" series of mechanical motions which are physically integrated with one another via the nature and essence of the gyroscopic

particle — the basic entity of all Matter in the Universe and the entity which comprises all electromagnetic fields throughout the Universe. In essence, *everything in the Universe* moves in alignment with the gyroscopic-action-entity composition of respective magnetic and electric fields — an effect commonly called "gravity." As I have already stated, gravity is in reality the "Unequaling Effect" of the gyroscopic-action-entity composition of Matter.

51  
**F.** At this point one may raise the following question: Does the Central Entity of the galaxies *also* orbit some *other* entity or does it "sit" suspended in space while spinning, motionless, or what? I am certain that such a Central Entity would at least be spinning, but this has yet to be proven. Could it, in fact, be orbiting an *even larger* entity?

52. Further observational proof that my teachings are correct is evident from an article entitled "The Case of the Cosmic Bends" in the August 6, 1984 issue of *Time Magazine*, page 57.

52  
**A.** The article states that an astronomical test was conducted by the use of 27 radio telescopes placed across 21 miles of the New Mexico desert at a cost of \$78.3 million.

52  
**B.** It is obvious to me that the scientists involved in the project were trying to be honest and dedicated individuals. However, judging by their conclusions, it is clearly demonstrated to me that such scientists have been "unjustly influenced" by our teaching system which actually rewards memorization and penalizes or ignores curiosity.

52  
**C.** The *Time Magazine* article states that the scientists observed a "spectacular feature that has never before been closely observed: a band of gas 10 to 20 light-years thick, seemingly composed of lacy filaments, stretching up to 600 light-years above the plane of the Milky Way." (See Figure 52-C.)

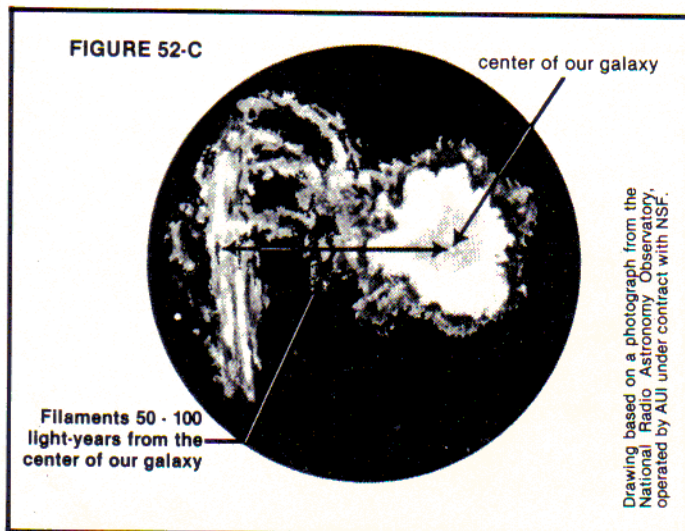

<sup>52</sup>  
D. The article indicated that the observed "spectacular feature" was arced. The article adds:

*"Indeed, the appearance of the magnetic arc was so unlike anything ever before observed in the universe that for weeks its three discoverers refused to accept their own finding.*

*"... others are now leaning toward the presence of a powerful and mysterious magnetic field as the most plausible cause.*

*"The magnetic field, if it exists, defies scientists' notions about proper celestial behavior. Perhaps even more baffling to astronomers, the belt of gas rises up at a right angle to the plane of the Milky Way ..."* (Emphasis added.)

*"So far the strange arc has raised only questions, not answers. Once gravity was thought to be the sole force shaping the large scale of the galaxy. Now it has lost some more of its supremacy to whatever molded the giant ribbon of gas."*

---

***"Perhaps even more baffling to astronomers, the belt of gas rises up at a right angle to the plane of the Milky Way ..."***

---

<sup>52</sup>  
E. At this point, I will simply draw a figure of what these astronomers have discovered and compare the results with my teachings.

planets' plane with respect to the electromagnetic axis of our Sun. (See Figure 43-A.)

<sup>52</sup>  
G. The reader should return to Fred Hoyle's statement (in Section 38-A) which he made many years ago and which clearly demonstrates the observed results in Figures 52-C and 52-E.

---

***"... all galaxies orbit a Central Entity and are not traveling, expanding, or contracting to some unknown position in a straight line."***

---

<sup>52</sup>  
H. Return also to my statement in Section 38-D in which I described a "duplicate effect" of the Sun's polar plumes (featured in Figure 38-A2) and the top and bottom arrows of the galactic magnetic field in Fred Hoyle's Figure 38-A. The reader can easily see the *exact same results* of our Galaxy's plumes ("filaments") as they mirror the "electromagnetic coupling effect" of our Galaxy to the Central Entity orbited by our Galaxy and other detectable galaxies.

<sup>52</sup>  
I. It is obvious that our Galaxy has the same relationship to the Central Entity (which the galaxies orbit) as I have demonstrated that the Earth has to the Sun, the Moon has to the Earth (see Section 34-A through Section 35-I), the planets have to the Sun, and the Sun to our Galaxy.

<sup>52</sup>  
J. Such observations enable me to conclude that *all* galaxies orbit a Central Entity and are not traveling, ex-

FIGURE 52-E

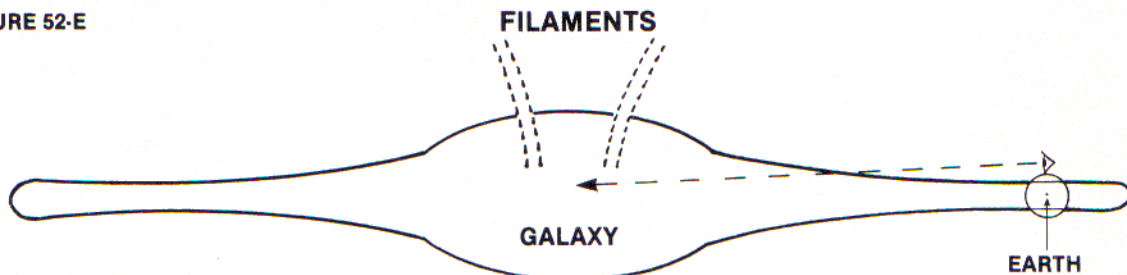
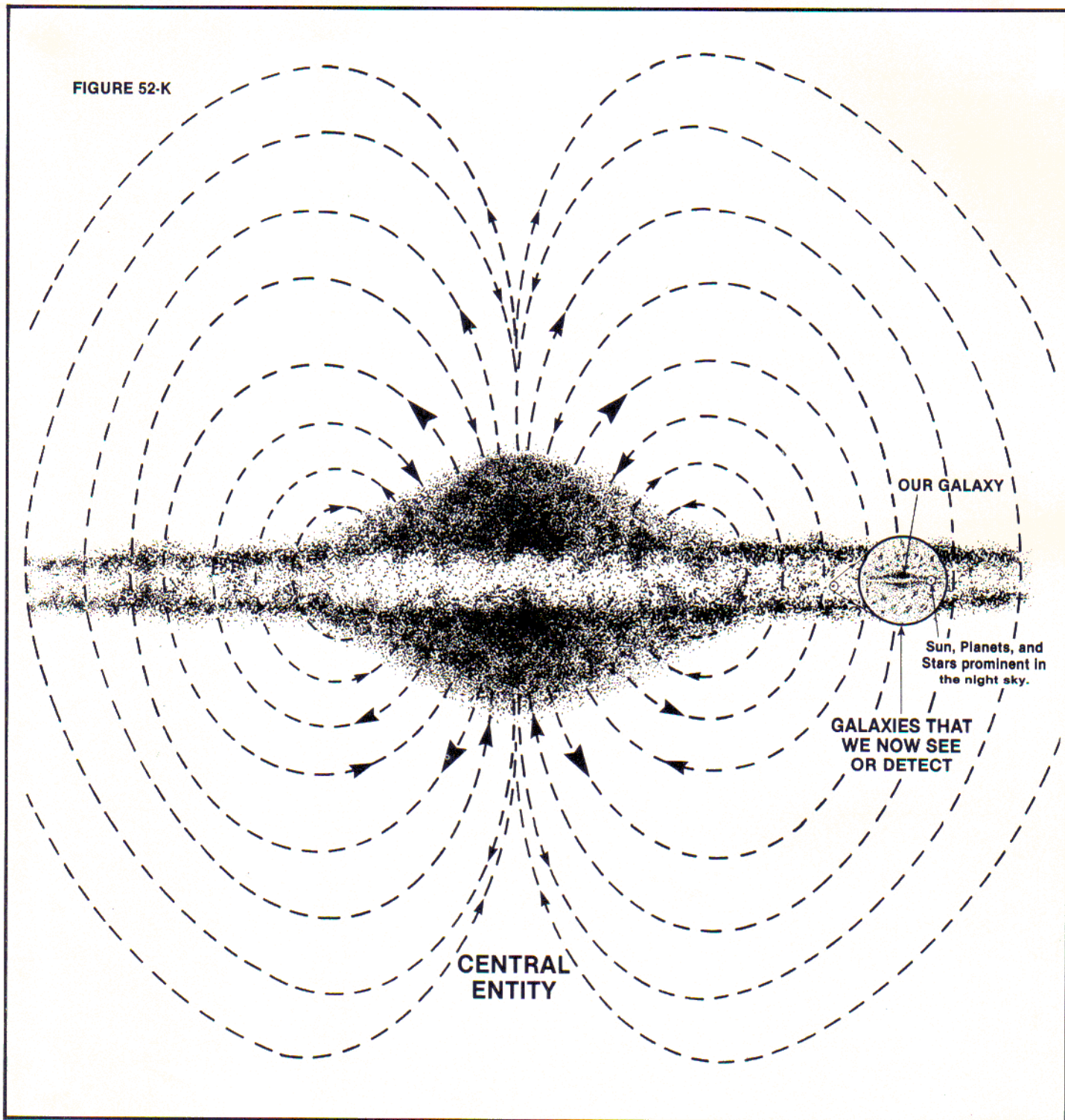

Figure 52-E is based upon the description provided by the astronomers who have detected these magnetic filaments arcing from the core of our Galaxy.

<sup>52</sup>  
F. Observe in Figure 52-E that the galactic plane with respect to its electromagnetic axis is the same as the

panding, or contracting to some unknown position in a straight line. (Remember that it is estimated to require 200 million years for the Sun to make one complete orbit of our Galaxy. One may extrapolate that this time is probably squared [or better] for our Galaxy to make one complete orbit around its Central Entity.)

K. What is known about observed galactic motion should be updated to a drawing such as Figure 52-K:



QUESTION: Does the Central Entity orbit some other, even larger, "Super-Central-Entity"?

52

L. As the facts of universal motion would indicate — planets to the Sun, stars to our Galaxy, and our Galaxy to its Central Entity — **all orbit in a plane** (see Section 42-A) **which is at right angles to the axis of the electromagnetic field of the entity being orbited.** (Field warpage will affect such angles.)

Such right angular motion clearly and consistently demonstrates the nature of the basic gyroscopic-action-entity composition of all Matter and Energy of the Universe, since, when *any* force (*i.e.*, attraction, repulsion, centrifugal, etc.) acts upon this basic gyroscopic-action-entity, then that entity *moves at right angles* to that force resulting in a rotational motion of one entity around another. **The basic gyroscopic-action-entity mechanically unifies the various fields observed within the Universe.**



CHART 53-B

**EARTHQUAKE AND VOLCANIC ERUPTION "DISASTERS" PLACED IN MONTHLY ORDER — DATES ARE HIGHLY SIGNIFICANT!**

MARCH	APRIL	MAY	JUNE	JULY	AUGUST	September	October	November	December	January	February
YEAR DAY(S)	YEAR DAY(S)	YEAR DAY(S)	YEAR DAY(S)	YEAR DAY(S)	YEAR DAY(S)	YEAR DAY(S)	YEAR DAY(S)	YEAR DAY(S)	YEAR DAY(S)	YEAR DAY(S)	YEAR DAY(S)
1977 4	1906 ?	1976 6	1956 10	543 9	1949 5	1262 1	530 6	1755 1	856 ?	1962 10	1783 4
1963 17-21	1906 16	1902 8	1948 28	551 9	1868 13	1923 1	1737 11	1976 24	1631 16	1693 11	1797 4
	1906 18	1875 16	1976 26	1969 25	546 15	1975 6		521 29	1920 16	1915 13	1976 4
	1972 10	*1980 18		1963 26	1950 15	1954 9			1946 21	1907 14	1960 29
		526 20		1976 28	1896 16	1978 17			1972 23	1951 18	1953 12
		1293 20			1976 17	1290 27			1932 26	1536 24	
		1960 21-29			1966 19				1939 27	1939 24	
		1935 30			79 A.D. 24				1828 28	1531 26	
		1970 31			1883 26				1908 28		
					1886 31				1974 28		
					1968 31				1703 30		

\*Mt. St. Helens initially gave warning of its potential on March 27, 1980, only six days after the Earth crossed the Sun's equator and went into opposite sunspot polarity. Cumulative effects then occurred within the volcano causing it to erupt on May 18, 1980. Over a four year period, Mt. St. Helens has produced activity within a 30-day period of March 21st — the day the Earth crosses the Sun's equator.

**TORNADO AND HURRICANE "DISASTERS" PLACED IN MONTHLY ORDER — DATES ARE HIGHLY SIGNIFICANT!**

MARCH	APRIL	MAY	JUNE	JULY	AUGUST	September	October	November	December	January	February
YEAR DAY(S)	YEAR DAY(S)	YEAR DAY(S)	YEAR DAY(S)	YEAR DAY(S)	YEAR DAY(S)	YEAR DAY(S)	YEAR DAY(S)	YEAR DAY(S)	YEAR DAY(S)	YEAR DAY(S)	YEAR DAY(S)
† 1925 18	† 1936 5-6	† 1896 27	h 1953 9	h 1967 9	h 1969 17-19	h 1930 3	h 1976 1	h 1971 1	h 1974 25		† 1884 19
† 1932 21-22	† 1965 11	† 1953 11	h 1882 5		h 1955 18-19	h 1928 12-17	h 1963 3-8	h 1970 13			
† 1952 21-22		h 1963 28-29	h 1957 27-28		h 1893 22-30	h 1947 15-19	h 1881 8	h 1977 21			
		h 1965 11-12	h 1972 16-23		h 1900 27	h 1974 19-20	h 1960 10/31	h 1703 26-27			
		Both Hurricanes in Pakistan!			h 1954 31	h 1934 21	h 1954 12-16				
					h 1938 21	h 1938 21	h 1942 16				
					h 1955 22-28	h 1955 22-28	h 1935 21				
					h 1954 26	h 1954 26	h 1959 27-28				
					h 1959 26-27	h 1959 26-27	h 1876 31				
					h 1958 27-28	h 1958 27-28	h 1949 31-2				

† = TORNADO      h = HURRICANE

FIGURE 53-D

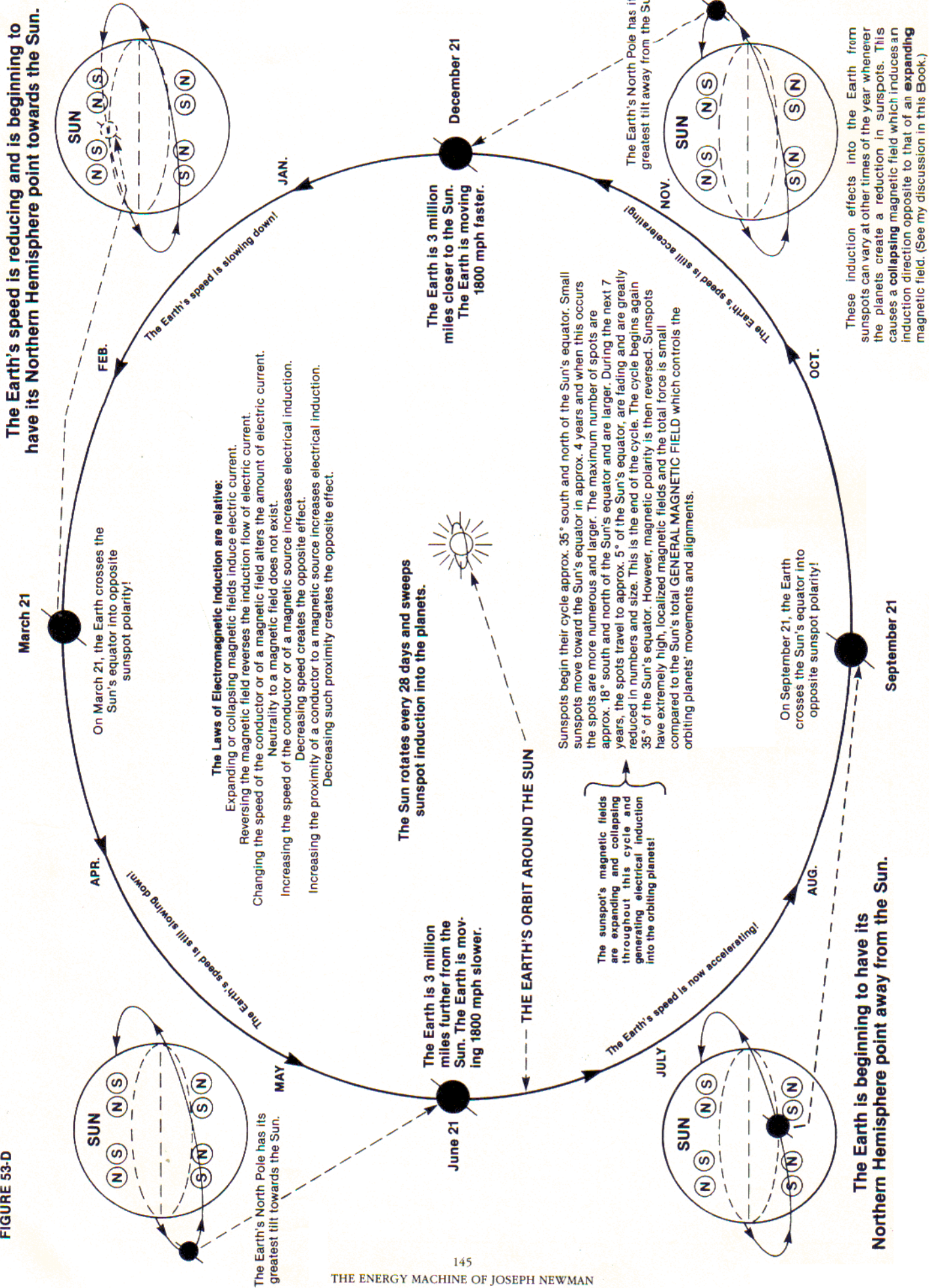

53. Additional proof that my teachings are correct is afforded by the scientific facts regarding "natural disasters." Because of Dr. Huntington's work, as well as my own, I searched for such additional proof. I initially attempted to locate the statistics concerning the exact dates for earthquakes, volcanic eruptions, and storms, but the exact dates were unavailable. Knowing that historians generally record the exact dates for such events which cost lives or cause great financial damage, I went to the library to search further. In the World Book Encyclopedia (published by World Books Inc., Chicago, Illinois, 1980 Edition) under the section "Disasters of the World," I did find the precise dates I had expected.

53  
A. The reader should be aware that there was no orderly listing of the "natural disasters" for which I was searching. Therefore, I simply listed such events under Months-of-the-Year. The "Earthquake and Volcanic Eruption Disasters" and the "Tornado and Hurricane Disasters" were arranged in separate 12-month periods. Reason: The Earth's mass (inertia effect) of solid material is far more resistant to change than the mass (inertia effect) of gas molecules in the Earth's atmosphere. I therefore expected an "accumulation effect" for the Earth's solid material and a more "instantaneous effect" for the atmosphere (gases) of the Earth. I was also certain that these natural events would occur in accordance with the Laws of Electromagnetic Induction. I also knew 1) the speed of the Earth, 2) the Earth's tilt with respect to the Sun, 3) when the Earth crossed the Sun's equator into opposite sunspot polarity, 4) the direction of the Earth relative to sunspots varied from month to month, and I was certain that these facts would prove the existence of the electromagnetic effect.

53  
B. See the "Disasters of the World" Chart 53-B arranged by months and observe that *many of these disasters occur very close to the same day under a given month even though such events occur hundreds of years apart from one another*. Observe that there is an "order" and "mechanical nature" (the electromagnetic effect) to these events:

53  
C. Because Chart 53-B contains a random selection of scientific events on Earth (Disasters), the mathematics of probability states that these results will not noticeably change if the exact dates for *all* earthquakes, eruptions, and storms were included, *i.e.*, where loss of life and property damage were not significant.

53  
D. Closely examine Chart 53-B and I will demonstrate how the description in Section 53-A applies to the observed results. The effects of the Laws of Electromagnetic Induction are quite obvious. Examine Figure 53-D concerning the Earth's motion and speed around the Sun as the Earth passes through initial sunspot induction and reverse sunspot induction.

53  
E. The reader may find it interesting that Figure 53-D was published approximately on a full page of the *Mobile Press Register* newspaper on June 29, 1980, Section B. I had been informed that there would be a planetary "alignment" in 1982 and I predicted unusual storms, volcanic eruptions, earthquakes, etc., from 1980 through 1985 when the planets would then be in greater unalignment. Independently of my work, the national news media has since featured documentaries which have discussed unusual weather conditions around the world during this time. Such conditions cannot be explained by conventional wisdom. QUESTION: Do you the reader believe that I only "guessed" this result?

53  
F. As it turned out, the action-reaction effect of storms, etc., was not as great as I had expected, so I searched further into the facts and found that *there was no planetary "alignment," but only a general-area-positioning of the planets* similar to a shotgun blast upon a target.

53  
G. In my scientific document of 1976, I initially predicted catastrophes *whenever planetary "alignment" occurred*. Other individuals informed me that such "alignment" has already been predicted in a book entitled *The Jupiter Effect*.

53  
H. The facts have clearly shown that there was NO "alignment," but only a very general, shotgun-blast-type alignment in 1982. *What the world has encountered from just that very slight "alignment" via earthquakes, storms, eruptions, etc., is only a preview of what will occur. It is possible that far greater "alignment" will occur in May of the year 2000. (As of the time of writing this Book, I have received conflicting reports regarding such alignment.) I urge the reader to Master what I teach. We have several years to prepare for effects that will occur several years before and after that date, if true alignment does occur.*

54. A. Return to Chart 53-B. Observe that a large number of earthquakes and volcanic eruptions (as Mt. St. Helens) began on March 21 when the Earth crossed the Sun's equator and entered opposite sunspot polarity. This caused an opposite electromagnetic induction effect into the Earth (*i.e.*, the Sun rotates every 28 days and sweeps sunspot induction into the Earth) as the Earth travels into a cumulative "action-reaction effect" since the greatest number of sunspots occur 18 to 20 degrees from the Sun's equator. The Earth is more likely to be affected by the sunspots in April and May due to the position of the Earth relative to the Sun. As a result, this cumulative "action-reaction effect" peaks upon the Earth in April and May.

54  
B. The reader should note that for four sequential years, Mt. St. Helens — which is in the Earth's North-

ern Hemisphere — demonstrated volcanic activity around the time the Earth crossed the Sun's equator on March 21. By this time, the Earth has begun to point its Northern Hemisphere towards the Sun.

<sup>54</sup>  
C. On Chart 53-B for the month of June, the reader can observe that there is little sunspot activity affecting the Earth because the Earth is at its farthest distance from the Sun and has reduced its speed around the Sun by 1800 miles per hour. [Moving a copper wire *quickly* through and closer to a magnetic field's source, will have a different induction effect from that of moving the copper wire *slowly* through a magnetic field and further from the source of that magnetic field.] The slower speed of the Earth and its further distance from the Sun reduces the electromagnetic induction effect and thus produces a reduction in earthquakes and volcanic eruptions.

<sup>54</sup>  
D. During July, the Earth *begins to travel in an opposite direction relative to the Sun.* (Re-examine Sections 44-G and 44-H which demonstrate the electromagnetic effect of this direction change.) Sunspot reduction causes a collapsing electromagnetic field which in turn produces a greater electromagnetic effect. Such an effect is observed in July into August as the Earth is more apt to be influenced by sunspots which are most

and earthquakes peaking in December and January. Such peaking continues into February since the Earth's direction relative to the Sun begins to reverse on December 21.

<sup>54</sup>  
F. From December 21 through June 21, the Earth travels farther from the Sun and decreases its speed around the Sun. Similarly, in accordance with their particular orbital year which differs from the Earth's orbital year, the other planets will also alter their relationship with respect to the Sun which in turn causes increased/decreased sunspot activity. Such sunspot activity causes the Sun's electromagnetic fields to expand and collapse. This is further complicated by the Sun's rotation every 28 days which causes a "sweeping" electromagnetic induction effect into the Earth that is similar to the sweeping beam of a lighthouse.

The Facts I have presented clearly demonstrate the cumulative "action-reaction effect" caused by astronomical electromagnetic induction which results in earthquakes and volcanic eruptions upon the Earth.

55. A. Examine Chart 53-B concerning storms, hurricanes, and tornadoes. The same explanation which I have provided for earthquakes and volcanic eruptions also applies to tornadoes and hurricanes. There is a difference, however: the electromagnetic induction

---

***"The Facts I have presented clearly demonstrate the cumulative 'action-reaction effect' caused by astronomical electromagnetic induction which results in earthquakes and volcanic eruptions upon the Earth."***

---

numerous 18 to 20 degrees from the Sun's equator. There is also an increase in earthquakes and volcanic eruptions upon the Earth.

<sup>54</sup>  
E. On September 21, the Earth again crosses the Sun's equator and is again under the influence of fewer numbers of sunspots. However, the Earth is now in opposite polarity with respect to the Sun and the Earth's speed is still increasing which increases the electromagnetic effect. Maximum sunspot activity occurs 18 to 20 degrees North and South of the Sun's equator and the Earth is most apt to be affected by such sunspots in October and November. However, curiously enough, the "cumulative effect" lags behind that in the Spring. (See Section 54-A.) This lag is evident since the cumulative "action-reaction effect" peaks in December and January. The difference in timing may be a result of the Earth's speed, *i.e.*, on December 21 the Earth is closest to the Sun (three million miles closer than on June 21) and the Earth's speed increases by 1800 miles per hour compared to its speed on June 21. This greater proximity and speed increase magnify the electromagnetic induction effect of the Earth into the Sun ("triggering effect") and vice versa from the Sun into the Earth which results in the increased "cumulative effect" of volcanic eruptions

effect with respect to storms is not as cumulative as that for earthquakes and volcanic activity.

<sup>55</sup>  
B. The mass (inertia) of air molecules (gas) is extremely light compared to the mass of the Earth. Consequently, electromagnetic induction is more rapid in its effect upon the Earth's atmosphere (gases).

Examine the following facts:

<sup>55-B</sup>  
(1) **Spring is noted for tornadoes.**

<sup>55-B</sup>  
(2) **Fall is noted for hurricanes.**

<sup>55-B</sup>  
(3) **On March 21 the Earth crosses the Sun's equator and into opposite sunspot polarity. At this time the Earth's Northern Hemisphere begins to point towards the Sun.**

<sup>55-B</sup>  
(4) **On September 21 the Earth crosses the Sun's equator, but the Earth is now traveling in an opposite direction relative to the Sun (and to that direction of March 21), and the Earth again enters opposite sunspot polarity. At this time the Earth's Northern Hemisphere begins to point away from the Sun.**

**55**  
**C.** Compare the facts in Section 55-B with the Storm Chart in Section 53-B:

**55-C**  
(1) **Six out of nine tornadoes occurred within 30 days of March 21 — the date the Earth crosses the Sun's equator into opposite sunspot polarity.**

**55-C**  
(2) **Two of the nine tornadoes occurred on March 21.**

**55-C**  
(3) **Approximately ¼ of the tornadoes occurred on March 21.**

**55**  
**D.** CONCLUSIONS:

**55-D**  
(1) **Realizing that there are 9 tornadoes occurring within 365 days, then the mathematical odds are 40.5 to 1 against a tornado occurring on March 21.**

**55-D**  
(2) **Realizing that 2 of the 9 tornadoes occurred on March 21, then the mathematical odds are 1,640 to 1 against two tornadoes occurring on the same date that the Earth crosses the Sun's equator.**

**55-D**  
(3) **The fact that I did not specifically select these tornadoes from a large number of tornadoes (i.e., these were the only tornadoes listed under the "Disaster" section) provides sound scientific evidence that my teachings are correct.**

**55**  
**E.** Compare the Storm Chart 53-B concerning hurricanes to statement 55-B:

**55-E**  
(1) **Twenty-five of 36 hurricanes (69%) occurred within 41 days of September 21 — the day the Earth crosses the Sun's equator into opposite sunspot polarity.**

**55-E**  
(2) **Nine out of 36 hurricanes (25%) occurred within 6 days of September 21.**

**55-E**  
(3) **Four of the 36 hurricanes (11%) were formed within 1 day of September 21.**

**55-E**  
(4) **Two of the 36 hurricanes were formed on September 21. The mathematical odds against such an occurrence is 102 to 1.**

**55-E**  
(5) **Storm Chart 53-B demonstrates that tornadoes are concentrated in the Spring when the Earth begins to point its Northern Hemisphere towards the Sun and causes an electromagnetic induction effect upon the land surfaces of the Earth.**

**55-E**  
(6) **By comparison, the hurricanes are concentrated in the Fall when the Earth begins to point its Northern Hemisphere away from the Sun and causes an electromagnetic induction effect to be generally centered over equatorial regions which contain large bodies of water. The evapo-**

**ration effect and the electromagnetic induction effect combine to produce hurricanes.**

**55**  
**F.** In the Fall (September 21), the Earth approaches the Sun and increases its orbital speed around the Sun. This causes the electromagnetic induction to increase and can result in greater air masses, i.e., hurricanes.

**55**  
**G.** The variability of the following factors explains why hurricanes and tornadoes do not occur only at certain times, but vary from year to year, decade to decade, and century to century:

**55-G**  
(1) **the "action-reaction effect" caused by electromagnetic induction as a result of increasing/decreasing sunspot activity triggered by planetary configuration**

**55-G**  
(2) **the "sweeping action" of changing electromagnetic induction effects generated by the Sun's 28 day rotation**

**55-G**  
(3) **the orbital speed of the Earth**

**55-G**  
(4) **proximity of the Earth and Sun**

**55-G**  
(5) **the Earth's Northern Hemispheric degree of tilt with respect to the Sun**

**55**  
**H.** If tornadoes and hurricanes formed only as a result of interacting cold and warm air masses, then those storms could be very accurately predicted. But the facts prove the opposite:

**55-H**  
(1) **Cold and warm fronts often meet and there are no hurricanes or tornadoes produced.**

**55-H**  
(2) **Hurricanes or tornadoes are often produced when they are not expected by meteorologists. This is why planes are flown into potential hurricane disturbances to physically detect and observe the storm's nature.**

**55-H**  
(3) **Totally unexpected, clear-weather tornadoes have been documented. [See *Handbook of Unusual Natural Phenomena*.]**

**55-H**  
(4) **Electrical and magnetic disturbances associated with tornadoes have been clearly documented. [For such documentation, I recommend reading pages 342 through 366 of the *Handbook of Unusual Natural Phenomena* by William Corliss.]**

I. The following is a report of my personal experience from my scientific notes:

### Unusual Electrical Observations

Time: Monday, 26 April, 1982, approximately 6:30 PM CST

Place: My home in the woods, approximately four miles from Lucedale, Mississippi

From a northwest direction I observed a dark cloud moving towards my home and traveling in a southeast direction.

Because of my scientific work, I take such clouds seriously during this time of the year, and consequently, I opened all screened doors and windows, enabling differences in potential pressure changes to quickly equalize.

There was much lightning occurring within this cloud, but the lightning did not appear to be striking the Earth.

My home is in the midst of pines, dogwoods, oaks, etc. My closest neighbor is approximately three-quarters of a mile away.

My lovely, devoted wife Ellen and I began to hear a 'zapping' noise occurring in varying outdoor areas. At the time we had a German Shepherd named Sport (now deceased) and a part-Persian cat called Mama Kitty (whom we still have) which normally stay under the converted carport when a rain storm approaches. However, on this particular occasion, both the dog and cat left and went somewhere into the woods just as the cloud approached our house.

The 'zapping' noise sounded like an electrical discharge as one would normally hear from an electrified object discharging into another uncharged object.

There was lightning and thunder within the overhead cloud, but the lightning did not appear to strike the Earth.

As would any curious scientist, I observed the cloud and woods from varying positions of windows and doors.

Just as I was looking from one window in the direction from which the cloud was coming, there suddenly appeared directly in front of my vision — about 100 feet away — a very strong, swirling wind. I could see the trees vigorously twisting and twirling in that area. It was obvious that this was a rotational type of air current. What was so interesting was that the rotational air current started right in front of my eyes rather than coming through the pine thicket which begins about 200 feet in front of the open window from which I was looking.

The rotational air current came directly to our house and completely engulfed it. One of the doors I had braced open immediately and violently slammed shut. Before I could re-open the door, the rotational air current disappeared. (Within 20 minutes, the dog and cat returned.)"

<sup>55</sup>  
J. These observations, those of others, and my years of work, totally convince me that a tornado principally results from differences in the electromagnetic induction potential between a cloud or air (gas) areas and a particular ground area.

<sup>55</sup>  
K. The constant "zapping" noise we heard was coming from pointed limbs of trees, leaves, bushes, etc., discharging electrical charge from the Earth to the approaching cloud or vice versa. Such "zapping" ceased when the cloud was directly overhead.

<sup>55</sup>  
L. This does not mean that other mechanical factors such as jet streams and intersecting warm/cold fronts do not play an important role, although such activity can also be electromagnetically motivated. *This action is called the "thermocoupling effect" when two different, hot and cold conducting materials are con-*

*nected and produce electricity.* Up to a point, the greater the difference in temperature, the greater the current produced.

<sup>55</sup>

M. It is my opinion that tornadoes and hurricanes form more easily over flat or cleared areas since a stronger electromagnetic difference will exist (without quickly dissipating) between the Earth and the gasses (atmosphere and clouds) above the Earth. This same electromagnetic mechanical effect is observed with respect to lightning. Lightning rods will reduce or eliminate the damaging effects of lightning.

The very fact that a tornado will often slowly extend from a cloud towards the ground but fail to touch the ground, or may touch the ground and then lift again (and repeat this procedure many times) — clearly demonstrates this electromagnetic effect. (See Figure 55-M on the next page.)

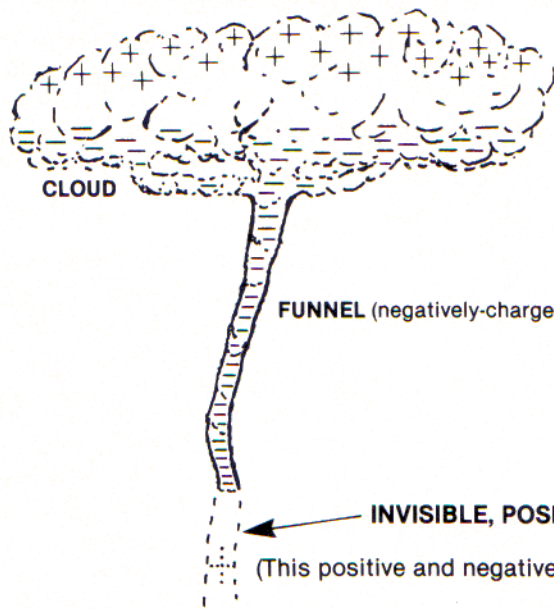

FIGURE 55-M

EARTH + + + + + + + +

The **EARTH** is a positively-charged surface in that area where the charged funnel cannot easily leak away.

Therefore, a tornado has an invisible, positively-charged funnel which rises from the ground and meets the negatively-charged cloud funnel. [I have already demonstrated that charges are composed of an infinite number of gyroscopic particles. Consequently, the spinning funnel is to be expected.]

The funnel will lift again as the cloud becomes more neutrally charged. Lightning represents the same mechanical, electromagnetic effect. However, in a tornado, the funnel can maintain a more direct and shorter distance of charge flow from the cloud or gas (clear atmosphere) and the Earth. The funnel lifts and drops according to the "charge differential." For the same reason, a funnel will start from the ground and rise into the air (gas).

55

**N.** A Kansas farmer, Will Keller, once saw what I have described. On June 22, 1928, while standing in the cyclone-celler door, Keller looked directly up and into the center of a tornado passing over his head. On page 132 of the *Time-Life* book entitled *Storm*, Will Keller states:

"... the walls of this opening were of rotating clouds and the whole was made brilliantly visible by constant flashes of lightning which zigzagged from side to side.

"Around the lower rim of the great vortex, small tornadoes were constantly forming and breaking away. These looked like tails as they writhed their way around the end of the funnel. It was these that made the hissing noise. I noticed that the direction and rotation of the great whirl was anti-clockwise, but the small twisters rotated both ways — some one way and some another."

This eye-witness description most definitely describes a charged funnel!

55

**O.** Quoting from the *Handbook of Unusual Natural Phenomena* by William Corliss, page 342:

"... conventional wisdom also has trouble dealing with forked waterspouts [Figure 55-Oa], waterspouts stretching between clouds [Figure 55-Ob] and waterspouts with two concentric tubes [Figure 55-Oc]."

FIGURE 55-Oa



FIGURE 55-Ob

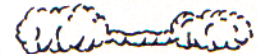

FIGURE 55-Oc

My comment: Those waterspout descriptions are clearly a description of electric charge (electromagnetism). This same effect is observed in connection with lightning.

Quoting again from the *Handbook of Unusual Natural Phenomena*, page 343:

*Electric Currents Accompanying Tornado Activity, Brook, Marx; Science, 157:1434, 1967. Abstract. Measurements of the magnetic field and earth current in the vicinity of a tornado show large, step-like deflections coincident with the touching down of the funnel. Calculations with a simple current model indicate that a minimum current of several hundred amperes must be postulated to account for the observed deflection in a magnetic field. The existence of a steady current of 225 amperes for a period of about 10 minutes provides joule heat at the rate of approximately  $10^{10}$  joules per second, and involves a total charge transfer of 135,000 coulombs. The calculations imply that a tornado is electrically equivalent to several hundred isolated thunderstorms cells active simultaneously.*"

<sup>55</sup>  
**P.** There are many additional pages of facts in the *Handbook of Unusual Natural Phenomena* which verify the electromagnetic effect and nature of tornadoes or waterspouts. *The observation in Section 55-O verifies the unusual electromagnetic intensity of a tornado. Again, this matches my teachings of increased electromagnetic induction from sunspots and/or the Sun.*

<sup>55</sup>  
**Q.** The above facts still necessitate a thorough mechanical understanding of the "action-reaction, electromagnetic induction effect." Consider all that I have taught and then examine Figure 55-Q.

In 1982, there was only a shotgun-type planetary alignment with the Earth and other planets on the *same* side of the Sun. However, from 1980 through 1983, unusual weather conditions, eruptions, etc., verify the "effect" of even a very minor planetary alignment. Even the news media have had reports on the unusual weather conditions throughout the world during this period.

<sup>55</sup>  
**R.** Although I am not certain as of this writing that it is true (but I do consider it potentially important enough to include in this Book), I have been informed that there will be a far more direct planetary "alignment" (similar to Figure 55-Q) except that the Earth will be on the *opposite side of the Sun from the other planets*. I was informed of such alignment by Tom Valentine — author of a book entitled *Life and Death of Planet Earth* (which I have not read) — who had an astronomer at Northwestern University compute alignment degree and date. According to the astronomer, there would be *very close to a straight-line, planetary alignment during the month of May 2000*. (Some individuals have also indicated a similar planetary alignment for that period while other individuals have indicated that there would be not true planetary alignment for that period. However, it is *very important* that astronomers conclusively confirm or deny such alignment and be capable of predicting when true planetary [as well as stellar] alignment would occur.)

<sup>55</sup>  
**S.** *Of this I am certain: if such direct planetary alignment does occur, the Facts have proven that "great bavoc" will be experienced by the Earth if me-*

FIGURE 55-Q

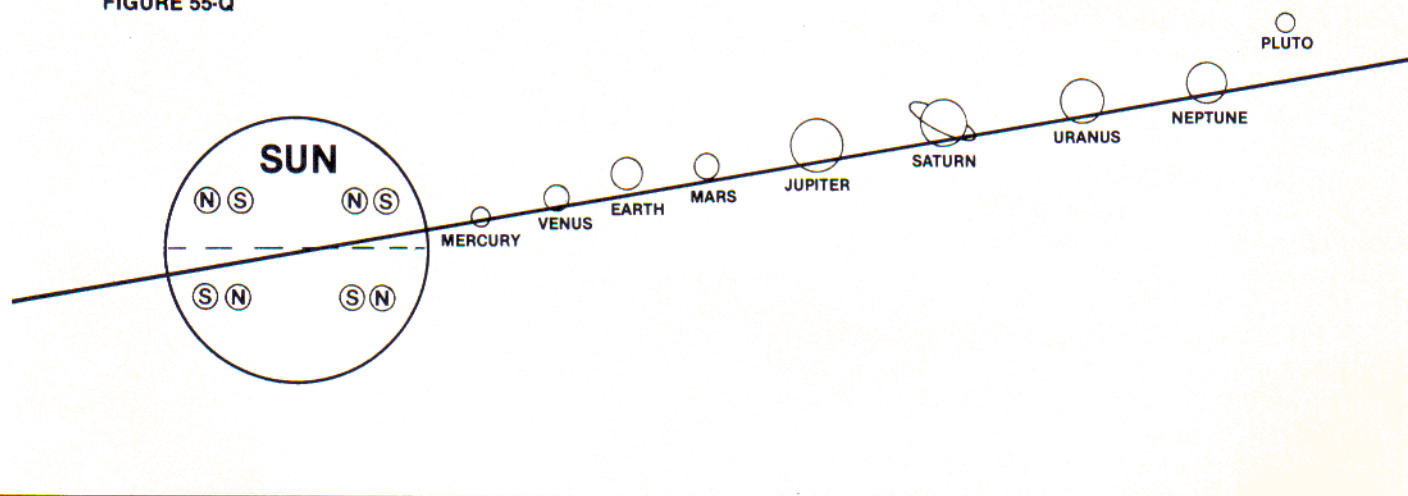

**QUESTION:** What do you expect will occur on Earth when all of the planets align in a *direct line on one side of the Sun*? What would occur upon the Earth if the planetary alignment was continuous except that the *Earth was on one side of the Sun by itself*?

**chanical preparation is not undertaken!** [I must add that the effect of such alignment upon the Earth will be influenced by the number of planets aligned, their actual degree of alignment, the planets' orbital position/speed with respect to the Sun at the time of such



alignment, and the effect of any degree of stellar alignment during this time.]

56. I now offer the following positive and creative concepts:

(1) I have taught the safe means for an enormous release of energy via  $E = MC^2$ .

(2) It is quite obvious that if excess electromagnetic induction causes any type of havoc upon the Earth (in May 2000 or at any time in the future), then the *opposite* must also be true: *one must produce an electromagnetic cancellation or control mechanism and such havoc will not occur!*

56  
A. For example, consider a potentially dangerous storm which is capable of producing tornadoes. (See Figure 56-A.)

56  
B. Instead of the meteorological formation in Figure 56-A, I propose the following:

56-B  
(1) A single large conducting grid or numerous conducting grids (with conducting connection to Earth) composed of aluminum can be either raised in the air (see grid in Figure 56-B1) when a storm approaches or can be carried to the potential storm as it begins to form. Massive balloons (see Figure 56-B1a) could actually lift the aluminum grid.

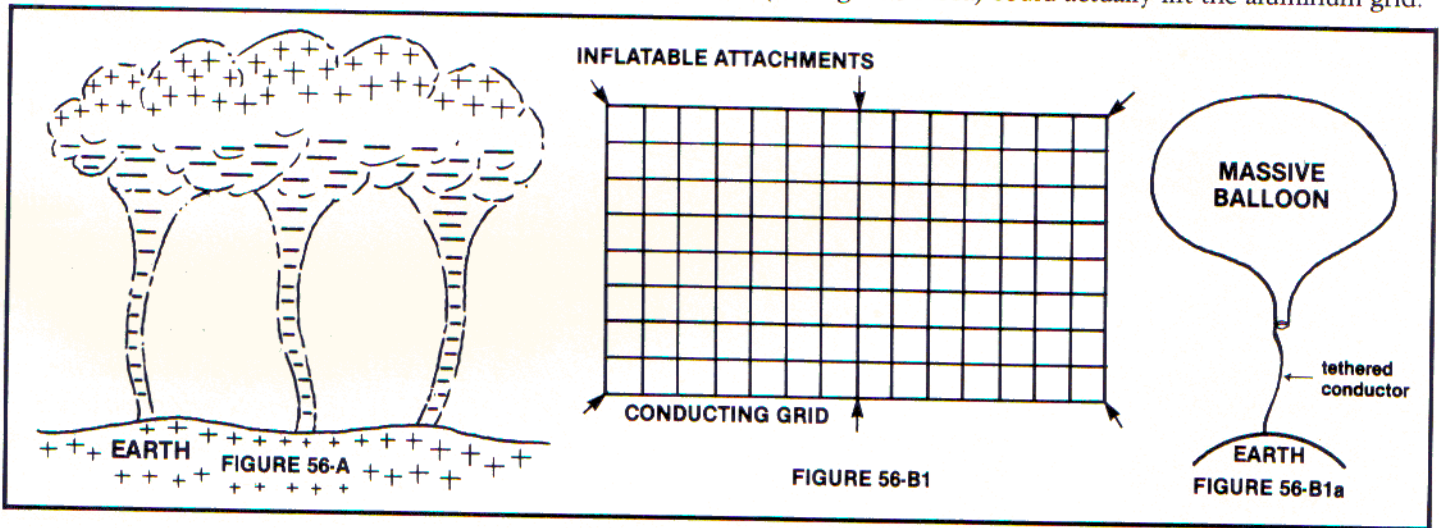

56-B  
(2) In fact, the massive balloons should be coated with a good conducting substance. If properly performed, the massive balloons could be used in large numbers in lieu of the grid. The balloon mechanism could also offer tethered conduction to the ground.

56-B  
(3) The most efficient design would be to utilize the energy source I have innovated and couple it with strong laser beams, X-rays, etc., to ionize the air throughout the cloud and to produce a good conducting connection between the Earth and the cloud as well as within the cloud itself. (See Figure 56-B2.)

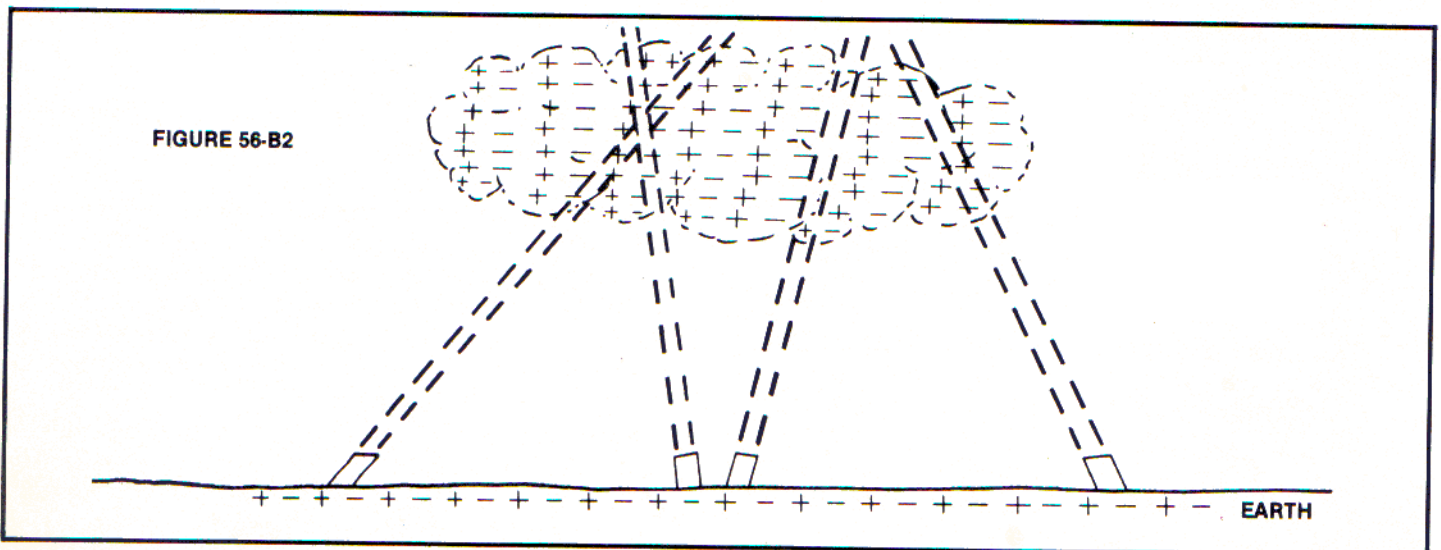

The lasers, etc., would be grounded, made to pivot, and placed at numerous points. If desirable, such lasers can be portable. I have learned that during the attempt to develop laser weaponry, the air ionization has been a problem by producing wasted energy. However, this problem is the *desired result of my proposal*. I have provided the energy source as the means.

<sup>56</sup>  
C. I strongly recommend that testing begin in earnest throughout major laboratories and universities — *NOW!* Clouds can be produced in a closed environment with a charging source for the produced clouds.

---

***“... the solution will allow the world to produce and direct its weather at will.”***

---

One can also produce an opposite charge on an artificial Earth within that closed environment. Under such conditions, one can test for the simplest, most efficient, and practical means to discharge the charged cloud to the artificial Earth as well as the mechanism necessary to intercept and cancel unwanted electromagnetic induction from the charging source.

<sup>56</sup>  
D. *I have no doubt that with such tests utilizing proper temperature differences, etc., one would find that the physical spinning of the entire environment within the test will generate the same results produced by natural storms observed on Earth: tornadoes and hurricanes.* When perfected, this would be a good test for Skylab.

<sup>56</sup>  
E. *A passive, “wait-and-see” attitude cannot be tolerated. Start to properly understand and prepare the mechanism NOW!* The ultimate goal is to stop all undesirable electromagnetic induction into the Earth’s environment. Superior technology will ultimately enable us to stop such undesirable electromagnetic induction in outer Space. This is why we must first perfect the technology on a small scale with Earth’s weather, and then apply such technology to outer Space. *When this occurs, we will be able to produce and direct our weather at will!*

<sup>56</sup>  
F. All of these “action-reaction, electromagnetic induction effects” can be duplicated in a laboratory (see Section 56-C) and a *mechanical means can be developed to intercept and redirect or cancel undesirable electromagnetic induction.*

**57.** Such undesirable effects constitute a problem faced by the entire world. *The entire world should and must unify as an entity of one!* The potential problem posed by planetary alignment can be converted into a positive tool for the benefit of all humanity. As I have already stated, *the solution will allow the world to produce and direct its weather at will.*

<sup>57</sup>  
A. I am very hopeful that this impending potential catastrophe (if it occurs in May 2000) can instead be converted into a positive benefit to encourage the entire world to think and work as a family of one.

<sup>57</sup>  
B. If the world can solve this potentially serious problem, then we will become aware that *as a family of one we can solve all problems.*

<sup>57</sup>  
C. If this potential catastrophe is not *now* acted upon, then it is possible that world devastation could be compounded by radiation leakage from nuclear reactors if any remain in functional existence. In addition, such possible devastation could possibly trigger nuclear weaponry, etc.

<sup>57</sup>  
D. I did *not* initially search for this potential disaster. On the contrary, the facts I have gathered proved to me that such disaster could be the case. Therefore, I searched for further proof. To do less would be irresponsible and totally unscientific behavior on my part.

<sup>57</sup>  
E. These statements concerning potential planetary problems have not been offered in a negative manner but just the opposite: they are made in a most positive manner. *It is my sole purpose to contribute to the “well being of all humanity.”*

---

***“Consider the fact that up to this time, no one has offered a single mechanical explanation for phenomena that we observe in the Universe.”***

---

**58.** What I teach is the means via a new source of energy (gyroscopic particles) to eliminate, control, and predict future disasters as well as to produce, control, and direct our weather. We will have the ability to convert deserts into oases by being able to convert salt water to fresh water and acquire valuable minerals in the process. Energy availability or environmental pollution will not be problems. Space travel will become commonplace. In fact, innumerable scientific doors will be opened.

<sup>58</sup>  
A. These many pages are the results of my sincere efforts to seek “TRUTH.”

<sup>58</sup>  
B. Observe that I have presented a single, scientific, mechanical explanation that has been consistent throughout my teachings, even though I have discussed many diverse scientific effects and subjects. Consider the fact that up to this time, *no one* has offered a *single mechanical explanation* for phenomena that we observe in the Universe.

Surely, he who “Masters” what I have written will understand the order of “TRUTH” in what I have taught.

I wish to pay “tribute” to Michael Faraday who was also correct and whose work inspired my search.

## Chapter 20

### ACHIEVEMENT VS. APATHY

"Men of great learning and retirement often contribute little or nothing to the progress of improvement. They spend their time in learning and admiring the inventions of others, without ever proposing a new thought of their own, or ever discovering one useful power in nature."

— Joseph Black

**59.** TO ALL WHO "MASTER" AND ARE INSPIRED BY WHAT I HAVE TAUGHT, IN THE REMAINDER OF THIS BOOK I SPEAK TO YOU:

<sup>59</sup>  
**A.** All of the many preceding pages of my teachings mean absolutely nothing if the major deficiencies of world society — fear, greed, intellectual dishonesty, and a lack of curiosity/intellectual aspiration — are not supplanted with superior attitudes.

I ask you — who I seek to inspire — to please "Master" my teachings which can correct such deficiencies. It is you who must apply what I teach to the world. With such application, I will predict the possibility of world peace as well as a productive and meaningful life for all individuals.

<sup>59</sup>  
**B.** It is only fair that I justify my sincerity and dedication to this desirable goal. Consequently, I will begin by providing you with a history of my efforts in the development of all that I have already taught.

<sup>59</sup>  
**C.** The following represents a very small sample of my voluminous correspondence with scientific agencies, universities, individuals, and elected officials. It is my hope that such correspondence will convince you of my dedication to what I teach.

Joe W. Newman  
3062 Pickell Drive  
Mobile, Alabama 36605

President Lyndon B. Johnson  
The White House  
Washington, D. C.

July 31, 1967

Mr. President:

I know you will receive this during troubled times and I would not impose upon you except that it be imperative that mankind utilize the attached information and that our nation be first to benefit by it.

I have not written, expecting that you prognosticate whether or not the attached information is of value; but to convince you of my sincerity; whereby, you will use your influence to insure that the attached scientific document is given all available scientific consideration with the greatest expediency.

I make my living inventing better machines. I do not allow myself the luxury of a mistake. With the funds derived from inventing, I do scientific research alone. I do this research not for money but because I am mentally compelled to do so. If I had all the money in the world, I would still do and get more pleasure out of research than anything man has to offer.

I am appalled at man's neglect for his fellow man. I have made myself a vow that I will not mentally be satisfied with myself until I have produced a machine and the method; whereby, the basic problems of mankind are a thing of the past. This attached document is a step in that direction. If I can get recognition for the information disclosed in this attached document, this recognition should enable me to get a grant from some source to build a prototype of the above mentioned machine, which I have already designed. I will also finish a document on the merger of economics and mechanization, as the method I mentioned above.

I respectfully await your earliest possible reply.

Sincerely,

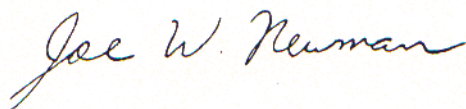
A handwritten signature in cursive script that reads "Joe W. Newman". The signature is written in dark ink and is positioned above the typed name.

Joe W. Newman

JWN:g

Attachment

March 9, 1974

1541 Bracher Drive  
Houston, Texas 77055

President Richard M. Nixon  
The White House  
Washington, D. C.

Mr. President:

Please find attached a cover letter and scientific document I am sending out to the scientific community.

I have not written asking you to give an opinion, but that if what I have written is correct; you would have the insight to know the information on the last page is also correct. I am certain an unlimited source of energy is possibly obtainable within one years time.

With the understanding of the importance of this possibility, I request you have qualified opinions be given you.

Mr. President, I am correct!

Sincerely,

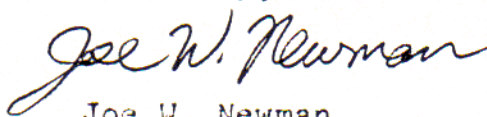

Joe W. Newman

JWN/e

Enclosure

December 30, 1974

1521 Deerwood Drive, East  
Mobile, Alabama 36618  
Phone: 205-344-9767

President Gerald Ford  
THE WHITE HOUSE  
Washington, D. C.

Dear Mr. President:

I doubt seriously that this letter will ever be brought to your attention, but the immense importance of this subject matter compels me to try.

Since 1967, I have diligently sought specific scientific argument against scientific material I have written. When I have personally approached Physics Professors they said I should get the opinion of Astronomy Professors and the Astronomy Professors would say I should get the opinion of the Physics Professors.

Through persistence, I have received correspondence from National Aeronautics and Space Administration, Atomic Energy Commission and National Science Foundation.

Of all the comments received from the scientific community, none have given specific scientific argument which has given me any doubt concerning my hypothesis. Any arguments first presented, disqualify themselves after I present my arguments.

All three of these National Departments end up suggesting that I get a scientific journal to publish my hypothesis. My Scientific Document and copies of all correspondence mentioned are attached, including scientific journals.

Most of the scientific community I forwarded a copy of my hypothesis made no comments.

The reluctance of the scientific community to take a stand on my hypothesis is illustrated by my correspondence with Dr. Dessler with the Space Science Department of Rice University in Houston, Texas. After reading my document, he called my by phone and give me his opinion. Quote: "I would not attempt to debate with you what you have written, you probably could be one of the greatest theoretical thinkers that has ever lived. However, I can imagine you are having difficulty getting response from other scientists because you have not presented your arguments in the accepted scientific form expected by the Scientific World. I would advise you go back to college to learn how to present your arguments in the accepted form." Unquote:

How ironic, that form and credentials are of more importance than the hint of truth to the scientific community.

President Gerald Ford  
Page two  
December 30, 1974

It should be apparent that I am not the average individual. Therefore, I must be a quack who can offer nothing of benefit to mankind or I must be a person with the ability to be of service to mankind. I have forwarded all of this material, whereby, you would be able to form an opinion as to which I am.

Mr. President, the World is in such an unstable economic condition that if there is the slightest indication that I am correct in my hypothesis, immediate action should be taken that would disprove or prove my hypothesis.

I welcome and challenge any scientist in the World to debate with me on my hypothesis by exacting scientific argument. Truth is what is important here, not form or credentials. Surely, all of my work and efforts have earned me the right to expect the scientific community to take a stand; to agree or disagree in no uncertain terms.

The conclusion of my nine years of lengthy experiments, study and creative thought is that I am saying an Unlimited Source of Energy can be released from Magnetic and Electric Fields of Force. I have at present drawings of a prototype device that would accomplish this result. I estimate an investment of \$200,000. and within one year of diligent experiment, positive results. Because of its great importance, I have not shown this drawing to my Patent attorney or any investor.

I await your earliest possible reply.

Mr. President, I am correct!

Respectfully,



Joseph Westley Newman

JWN/en

Enclosures



August 28, 1975

1521 Deerwood Drive, East  
Mobile, Alabama 36618  
Phone: 205 - 344-9767

Vice-President Nelson Rockefeller  
ATTN: Mr. Frank Pagnotta  
THE WHITE HOUSE  
Washington, D. C.

Dear Mr. Vice-President:

I talked with Mr. Lacey by phone on the night of August 26, 1975, while you and he were in Mobile, Alabama. Mr. Lacey advised me to send this letter and the enclosed material to Mr. Pagnotta and that he would personally see to it that you received this immensely important material.

Please find enclosed a copy of my scientific document, a copy of Dr. Edward Leverne Moragne's letter dated August 7, 1975, concerning my document and a separate page showing Dr. Moragne's scientific accomplishments, a copy of a letter to President Johnson dated July 31, 1967, a copy of a letter to President Nixon dated March 9, 1974, and a copy of a letter to President Ford dated December 30, 1974.

For ten years now I have studied, thought, experimented and financed absolutely alone. I have purchased \$2,000. worth of books during this time concerning several fields; Astronomy, Physics, Chemistry, Medicine and they all have at their very base the same denominator, Electro Magnetic Energy.

Long ago I reasoned that (electric) magnetic fields must be the energy that makes up the material from which it comes. I am referring to a release of truly controlled atomic energy, with no potentially dangerous side effects to man or his environment. It has been a lonely feeling, realizing that what I see so clearly is unimaginable to most scientists.

I met Dr. Moragne in March, 1975, and we have talked frequently since that time. During this time I have forwarded him additional proof of my work on several occasions. The results of our talks brought about Dr. Moragne's letter. (2 pages of this recent information is in front of my 1975 document. Drawings are not enclosed, Neptune drawing is 12 feet, 11 inches long.)

It is obvious that the letter Dr. Moragne has written puts him in a position where he has nothing to gain and everything to lose.

Vice-President Rockefeller

Page two

August 28, 1975

I am sure you can appreciate my efforts, as I explained in the attached letter to President Ford dated December 30, 1974. That letter and all scientific correspondence ended up back at the National Science Foundation. A letter dated January 24, 1975, from H. Guyford Stever, Director of N.S.F., quoting mere scientific rhetoric is enclosed. My letter dated January 27, 1975, answering Mr. Stever's letter is also enclosed. The purpose of enclosing these two letters is to verify that I have found very few physicists qualified to even discuss the findings in my document. Add I feel that if you send my document to just anyone you may encounter the same. If you request Mr. Stever to give you all correspondence I sent to President Ford you will appreciate this statement.

The major point of all this, is that I am saying I can release an Unlimited Source of Energy from Electro-Magnetic Energy. This is simply using universal energy. This is basic, if man is to end all of his stupidity, hunger, greed, wars, disease, ageing, and advance to other solar systems! If there was one chance in one thousand that I was correct, it would still be the greatest return on an investment in the history of man. However, I have diligently sought to disprove my hypothesis for the last ten years, but over and over and over I have found proof that I was correct. So much so, that I state the mathematical odds of me being correct are phenomenal in my favor. I am at the point Edison was when he knew he could get light from electric current, but that he had to experiment to prove it.

I have found no one in the scientific community who could give exacting scientific argument against my findings. On the other hand, I have found a scientist of great proven ability that agrees with my findings and has obtained the interest of his colleagues.

Mr. Vice-President, I know that I have an ability that can be beneficial to mankind. Dr. Moragne has offered to help me. Will the government help me to help the government and the world?

It is in the interest of science and mankind that I ask for research money to be made available. I would appreciate your earliest possible reply concerning this most important matter.

Respectfully,

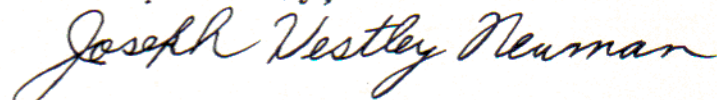

Joseph Westley Newman

JWN/en

Enclosures



OFFICE OF THE VICE PRESIDENT  
WASHINGTON

February 19, 1976

Dear Mr. Newman:

This will acknowledge your letter to the Vice President regarding your interest and scientific proposal in the field of electro magnetic energy and request for financial assistance to enable you to further research your project.

The Vice President appreciates your interest and has instructed that your correspondence be forwarded to Dr. Robert C. Seamans, Administrator of the Energy Research and Development Administration, where it will be further reviewed and given appropriate action.

The Vice President thanks you for bringing this matter to his attention.

Sincerely,

Frank R. Pagnotta  
Assistant to the Vice President  
for Administration

Mr. Joseph Westley Newman  
1521 Deerwood Drive, East  
Mobile, Alabama 36618

March 12, 1979

1521 Deerwood Drive, East  
Mobile, Alabama 36618  
Phone: (205) 344-9767

President Jimmy Carter  
The White House  
Washington, D. C.

Dear Mr. President:

This letter is written with the experienced knowledge that I will probably receive no responsible, exacting actions relative to this request. However, as I am a determined individual, because I have absolutely no doubt that I am correct, I persevere.

I can solve the energy problem as a result of 14 years of study, experimenting and deep creative thought! I have made my living solely as an inventor for the last 18 years. Science and Truth have been my major interest for the last 14 years.

Reference my credibility: Find enclosed 5 letters concerning my inventive ability (one of which is from the Governor of Alabama - Fob James, Jr.).

Find enclosed 7 letters from reputable scientific individuals which are complimentary of my scientific efforts. Two of these letters are from Dr. Robert E. Smith, Chief, Orbital and Space Environment Branch, Space Sciences Laboratory of NASA at Huntsville, Alabama. Dr. Smith's recent letter of February 26, 1979, describing the unexpected problem of getting exacting debate on my work of 14 years from some of his colleagues, outlines exactly, the typical scientific rhetoric I have received from the general scientific community for the last 12 years. (Studied and experimented for two years prior to seeking scientific debate).

Find enclosed copies of letters to Presidents of the past: President Johnson, July 31, 1967, President Nixon, March 9, 1974, President Ford, December 30, 1974, and to Vice-President Rockefeller, August 28, 1975. These letters explain in detail my efforts.

President Carter  
Page two  
March 12, 1979

As a result of these letters find enclosed copies of letters from National Science Foundation, Atomic Energy Commission, ERDA, other Department Heads of NASA, all saying they are unqualified to debate with me in an exacting, scientific manner on my scientific efforts. My letter of January 27, 1975 to Dr. Stever, (then) Director of National Science Foundation, explains my honest feelings of their scientific rhetoric.

In conclusion, I earnestly, again, ask the President of the United States to help me, help the people of my country and the people of all the world.

I can solve the energy problem! Find enclosed my scientific document that now consist of 92 pages of exacting, scientific statements, these statements are stated simply and clearly. There are no highly complicated mathematics or scientific rhetoric. I have studied, experimented and spent numerous hours in deep creative thinking during the last 14 years in compiling these scientific findings.

I earnestly request for you, President Carter, to demand the Federal Scientific Department Heads to all group together and agree or disagree in writing in an exacting, scientific manner to my 92 page scientific document. If all of these people are unqualified, as they say they are, to debate with me, then all of the major Universities in the U.S. be asked to prove me wrong. I also request for a board of individuals with high powers of reasoning be set up to review their written comments and my written comments in defense of my document.

If all of these people still claim they are unqualified to discuss exacting, scientific statements made simply, against what they have been taught, then it proves they do not truly understand what they have been taught.

Accordingly, President Carter, I ask that you then recognize that in itself is justification to give a Federal Grant to me so that I may complete my scientific efforts of 14 years (which I have financed solely alone) and release an Unlimited Source of Energy from Electromagnetic Fields of Force. I have read that you, Mr. President, are of scientific credibility. Please be advised that my scientific document is written so exacting, clearly and simply that you can read and understand what I have written.

President Carter  
Page three  
March 12, 1979

I know there are honest and credible scientists in every science field (such as Dr. Smith), but regrettably, that is the exception rather than the rule.

The future generations of this world and possibly other worlds, will be amazed at the scientific rhetoric and lack of Government Interest I have encountered and may still encounter in completing my scientific efforts, that will be of extreme benefit to this and all other generations.

For 14 years I have stood alone, against great odds. Must I continue to do so?

I would appreciate the earliest possible responsible reply.

Sincerely,

  
Joseph Westley Newman

JWN/en

Enclosures