



- (51) **International Patent Classification:**
C01B 3/34 (2006.01) H01M 8/06 (2006.01)
C01B 3/06 (2006.01)
- (21) **International Application Number:**
PCT/US2010/048125
- (22) **International Filing Date:**
8 September 2010 (08.09.2010)
- (25) **Filing Language:** English
- (26) **Publication Language:** English
- (30) **Priority Data:**
61/240,508 8 September 2009 (08.09.2009) US
- (71) **Applicant (for all designated States except US):** THE OHIO STATE UNIVERSITY RESEARCH FOUNDATION [US/US]; 1216 Kinnear Road, Columbus, OH 43212 (US).
- (72) **Inventors; and**
- (75) **Inventors/Applicants (for US only):** FAN, Liang-Shih [US/US]; 1216 Kinnear Road, Columbus, OH 43212 (US). LI, Fanxing [CN/US]; 1216 Kinnear Road, Columbus, OH 43212 (US). ZENG, Liang [CN/US]; 1216 Kinnear Road, Columbus, OH 43212 (US). SRIDHAR, Deepak [IN/US]; 1216 Kinnear Road, Columbus, OH 43212 (US).
- (74) **Agents:** HAGAN, Timothy, W. et al.; Dinsmore & Shohl LLP, One South Main Street, Suite 1300, Fifth Third Center, Dayton, OH 45402-2023 (US).
- (81) **Designated States (unless otherwise indicated, for every kind of national protection available):** AE, AG, AL, AM, AO, AT, AU, AZ, BA, BB, BG, BH, BR, BW, BY, BZ, CA, CH, CL, CN, CO, CR, CU, CZ, DE, DK, DM, DO, DZ, EC, EE, EG, ES, FI, GB, GD, GE, GH, GM, GT, HN, HR, HU, ID, IL, IN, IS, JP, KE, KG, KM, KN, KP, KR, KZ, LA, LC, LK, LR, LS, LT, LU, LY, MA, MD, ME, MG, MK, MN, MW, MX, MY, MZ, NA, NG, NI, NO, NZ, OM, PE, PG, PH, PL, PT, RO, RS, RU, SC, SD, SE, SG, SK, SL, SM, ST, SV, SY, TH, TJ, TM, TN, TR, TT, TZ, UA, UG, US, UZ, VC, VN, ZA, ZM, ZW.
- (84) **Designated States (unless otherwise indicated, for every kind of regional protection available):** ARIPO (BW, GH, GM, KE, LR, LS, MW, MZ, NA, SD, SL, SZ, TZ, UG, ZM, ZW), Eurasian (AM, AZ, BY, KG, KZ, MD, RU, TJ, TM), European (AL, AT, BE, BG, CH, CY, CZ, DE, DK, EE, ES, FI, FR, GB, GR, HR, HU, IE, IS, IT, LT, LU, LV, MC, MK, MT, NL, NO, PL, PT, RO, SE, SI, SK,

[Continued on next page]

(54) **Title:** INTEGRATION OF REFORMING/WATER SPLITTING AND ELECTROCHEMICAL SYSTEMS FOR POWER GENERATION WITH INTEGRATED CARBON CAPTURE

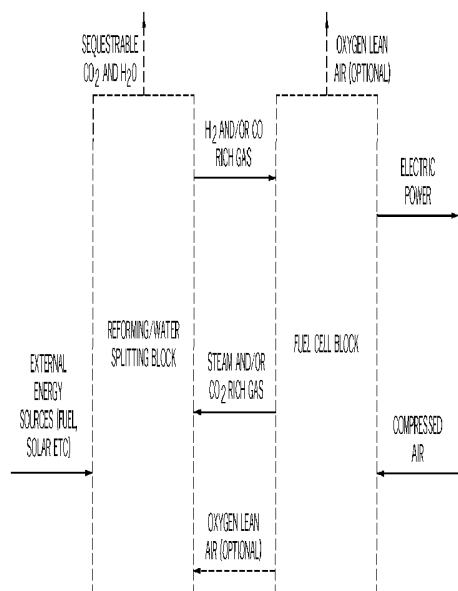

FIG. 1

(57) **Abstract:** High efficiency electricity generation processes and systems with substantially zero CO₂ emissions are provided. A closed looping between the unit that generates gaseous fuel (H₂, CO, etc) and the fuel cell anode side is formed. In certain embodiments, the heat and exhaust oxygen containing gas from the fuel cell cathode side are also utilized for the gaseous fuel generation. The systems for converting fuel may comprise reactors configured to conduct oxidation- reduction reactions. The resulting power generation efficiencies are improved due to the minimized steam consumption for the gaseous fuel production, in the fuel cell anode loop as well as the strategic mass and energy integration schemes.

WO 2011/031755 A1

SM, TR), OAPI (BF, BJ, CF, CG, CI, CM, GA, GN, GQ, — *of inventorship (Rule 4.17(iv))*
GW, ML, MR, NE, SN, TD, TG).

Declarations under Rule 4.17:

- *as to applicant's entitlement to apply for and be granted a patent (Rule 4.17(ii))*
- *as to the applicant's entitlement to claim the priority of the earlier application (Rule 4.17(iii))*

Published:

- *with international search report (Art. 21(3))*

-1-

Integration of Reforming/Water Splitting and Electrochemical Systems for Power Generation with Integrated Carbon Capture

The present invention is generally directed to systems and methods of electricity generation with in-situ CO₂ capture. In certain embodiments, a reduction-oxidation (redox) system using one or more chemical intermediates is utilized to convert carbonaceous fuel with CO₂ capture. This is followed by strategic integration with an electrochemical conversion device to produce electricity. In other embodiments, water splitting systems are integrated with the electrochemical systems. Through the process integrations, the process auxiliary power consumption and/or water utilization and energy used for steam generation are minimized.

Fossil fuels including crude oil, natural gas, and coal represent the majority of today's energy supply worldwide. The use of fossil fuels, however, requires that they be transformed to a carrier such as heat, electricity, liquid fuels, or chemicals through chemical conversion processes. With an increasing energy demand and concomitant concerns over the carbon emissions from fossil fuel usage, extensive efforts have been geared toward developing carbon neutral, efficient and economical energy systems that are sustainable. A transition from the use of fossil fuels to that of nuclear and renewable resources such as solar and biomass, thus, represents the natural progression of such efforts.

Existing electricity generation technologies have one or more of the following limitations/drawbacks: 1) high costs (e.g., photovoltaic, gasification, ultra-supercritical pulverized coal combustion); 2) low efficiency (e.g., sub-critical pulverized coal combustion); 3) environmental concerns (e.g., fossil fuel power plants); and 4) safety concerns (e.g., nuclear power).

One of the common issues with respect to a conventional thermal power plant is the large amount of exergy loss during cooling and reheating of steam. A system and method that minimizes the requirements for steam generation is thus desirable.

Chemical reactions between carbonaceous fuels and air/steam/CO₂ through the assistance of a reaction medium may represent an effective way to minimize exergy loss

-2-

in the fuel conversion process. A number of techniques have been proposed to convert carbonaceous fuels using metal oxide. For example, Watkins, U.S. Patent No. 3,027,238, describes a method for producing hydrogen gas including reducing a metal oxide in a reducing zone, and oxidizing the reduced metal with steam to produce hydrogen in an oxidizing zone. This technique, however, is limited to gaseous fuel conversion. Moreover, the gaseous fuel is only partially converted by the metal oxide. Thomas, US Patent No. 7,767,191; Fan, PCT Application No. WO 2007082089; and Fan, PCT Application No. WO 2010037011 describe methods for producing hydrogen gas by reducing a metal oxide in a reduction reaction between a carbon-based fuel and a metal oxide to provide a reduced metal or metal oxide having a lower oxidation state, and oxidizing the reduced metal or metal oxide to produce hydrogen and a metal oxide having a higher oxidation state.

Hydrogen can also be produced from water splitting through photoelectrolysis, thermolysis, and thermochemical routes.

To produce electricity, the aforementioned processes teach the further conversion of the hydrogen product in a gas turbine, gas engine, and/or fuel cell. However, a large amount of steam is used in these processes for hydrogen generation. Simple conversion of hydrogen in conventional hydrogen fueled power generation devices will lead to cooling and reheating of large amounts of steam/water, resulting in a large irreversibility of the power generation system.

With increasing demand for electricity, the need arises for improved processes, systems, and system components therein, which produce electricity with higher efficiency and fewer pollutants.

Embodiments of the present invention are generally directed to high efficiency electricity generation processes and systems with substantially zero CO₂ emissions. A closed loop between the unit that generates gaseous fuel (H₂, CO, etc.) and the fuel cell anode side is formed. In certain embodiments, the heat and exhaust oxygen containing gas from the fuel cell cathode side are also utilized for the gaseous fuel generation. The power generation efficiencies of the systems disclosed herein are significantly greater than state-of-the-art approaches due to the minimized steam consumption for the gaseous

-3-

fuel production, in the fuel cell anode loop, as well as the strategic mass and energy integration schemes.

Additional features and advantages provided by embodiments of the present invention will be more fully understood in view of the following drawings and detailed
5 description.

The following detailed description of the illustrative embodiments of the present invention can be best understood when read in conjunction with the following drawings, where like structure is indicated with like reference numerals and in which:

Fig. 1 is a general schematic illustration of a process for producing electricity
10 with minimal steam consumption in accordance with one embodiment in which a fuel cell is integrated with a reforming or water splitting system to minimize steam generation requirements in the process.

Fig. 2 is a general schematic illustration of an embodiment of the integration
15 of a fuel cell and redox based reforming/water splitting block for electricity generation with minimal steam requirements.

Figure 3 further illustrates the integration of an embodiment of an iron oxide redox based reforming/water splitting block and a fuel cell system.

Figure 4 is a schematic of an embodiment of an iron oxide based redox
process using syngas derived from solid fuels such as coal or biomass as feedstock.

20 Figure 5 is a schematic of an embodiment of an iron oxide based redox process using solid fuels such as coal, biomass, and/or solid wastes directly as feedstock and its integration with a fuel cell.

Figure 6 is a schematic of an embodiment of a calcium based reforming/water
splitting block integrated with a fuel cell.

25 Figure 7 is a schematic of an embodiment of a membrane enhanced reforming/water splitting block integrated with a fuel cell for power generation.

-4-

Figure 8 is a schematic of an embodiment of a zinc based water splitting block using solar or nuclear thermal energy and its integration with a fuel cell using solar or nuclear energy.

Figure 9 is a more detailed schematic illustrating an embodiment of an integrated coal to electricity system using redox reactions and a solid oxide fuel cell (SOFC).

Figure 10 illustrates an embodiment in which the unconverted fuel from the reducer of a redox based reforming/water splitting block is converted by an auxiliary fuel cell followed by an oxygen polishing step. The working fluid between the oxidizer and the fuel cell block remains a closed loop.

Referring generally to Fig. 1, embodiments of the present invention are directed to systems and methods for converting thermal and chemical energy sources into electricity with minimal steam consumption and/or auxiliary power generation and low to zero carbon emissions. All percentages are reported as weight percent unless otherwise noted or the context requires otherwise.

In one embodiment, the system is divided into two blocks or sub-systems, i.e. a reforming/water splitting block and a fuel cell block. The reforming/water splitting block generates gaseous fuels such as hydrogen, syngas, and/or light hydrocarbons from steam/ CO_2 and an energy source such as solar, nuclear, and carbonaceous fuel. The fuel cell block converts the gaseous fuel from the reforming/water splitting block into electricity while generating an effluent stream which contains unconverted fuel and steam and/or CO_2 , for the reforming/water splitting block.

The steam/ CO_2 effluent of the fuel cell block, which may contain unconverted fuel, is recycled to the reforming/water splitting block to generate gaseous fuel. In certain cases, minor reheating and re-pressurization of the effluent is required. Steam condensation and reheating is minimal in all cases.

To maintain the operating pressure of both the reforming/water splitting block and the fuel cell block, a bleed of effluent and/or gaseous fuel is split from the main

-5-

gaseous stream and re-pressurized. Meanwhile, a re-pressurized makeup stream is merged with the main gaseous stream. Because CO₂/steam circulates between the reforming/water splitting block and the fuel cell block along with the CO/H₂ fuel, the steam/CO₂ acts as a working fluid for electricity generation. The use of turbines, both
5 steam turbines and gas turbines, is minimized in this scheme since the partially converted gaseous fuel from the fuel cell is almost fully recycled to the fuel production stage. A closed loop of working fluid is formed between the reforming/water splitting block and the fuel cell block. By minimizing the steam condensation and reheating and maximizing the fuel conversion in the fuel cell, the irreversibility of the process is minimized.

10 In the case when a high temperature fuel cell such as a solid oxide fuel cell (SOFC) is used, the sulfur tolerance level is relatively high. Therefore, a simple hot gas clean up unit such as a calcium oxide sorbent bed can be integrated with the working fluid loop.

The operating pressure of the reforming/water splitting block is comparable to the
15 fuel cell block. Both blocks operate at pressures between 1.01×10^5 Pa and 8.11×10^6 Pa (1 atm and 80 atm). The temperature of the units ranges between 300 °C – 1300 °C. The high temperature, high pressure, spent stream from the system can be used to preheat the feed streams, generate power, and re-pressurize the makeup stream.

The energy source for the reforming/water splitting block can either be
20 carbonaceous fuels or thermal energy from other sources such as solar or nuclear. The carbonaceous fuels can include coal, methane, biomass, syngas, pet coke, extra heavy oil, wax and oil shale.

In the case when carbonaceous fuel is used, an oxygen carrier or CO₂ sorbent is used to reform/gasify the fuel into hydrogen and/or CO. In the case when thermal energy
25 from solar or nuclear is used, a thermo-chemical water splitting scheme is used to convert thermal energy to hydrogen and oxygen.

Figure 2 illustrates a general process configuration in which a carbonaceous fuel is indirectly reformed or gasified with steam/CO₂ using a metal oxide based oxygen carrying particle. The reaction in the reduction stage is

-6-



In most cases, the metal oxide, the reactor design, and the operating mode are selected such that at least 80% of the fuel is converted into CO₂ and steam. In some cases, an oxygen polishing step is used to fully combust the unconverted fuel (<20%) into
5 sequestrable CO₂ and H₂O. In preferred embodiments, at least 95% of the fuel is converted into CO₂ and steam. The exhaust gas stream from the reducing step is thus sequestrable.

The reaction in the oxidation stage of Figure 2 is

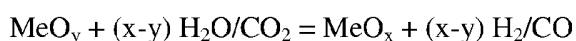

10 The feed for the oxidation stage, directly withdrawn from the exhaust of the fuel cell anode side (minor recompression is conducted in certain cases), contains fuels such as H₂/CO. The fuel concentration in the fuel cell exhaust/oxidation feed typically ranges from 0 to 60%. The H₂O/CO₂ in the feed stream is at least partially converted to H₂/CO, hence the fuel concentration in the gaseous stream is increased. The H₂/CO concentration
15 in the product stream of the oxidation stage typically ranges from 30% to 99% and is at least 5% higher than that in the exhaust stream of the fuel cell anode. The fuel enriched stream from the oxidation stage is then directly introduced back to the fuel cell for power generation.

Figure 3 illustrates a specific process configuration in which a carbonaceous fuel
20 is used as the fuel and iron oxide is used as the oxygen carrier. In this embodiment, a three reactor redox system is used to convert the fuel in a manner similar to that disclosed in Thomas, US Patent No. 7,767,191; Fan, PCT Application No. WO 2007082089; and Fan, PCT Application No. WO 2010037011. The first reactor, the reducer, is configured to oxidize the carbonaceous fuel into CO₂ and steam while
25 reducing a metal oxide based oxygen carrier. The heat required or generated in the reducer is provided or removed by the oxygen carrier particle. The second reactor, the oxidizer, is configured to (partially) oxidize a portion of the reduced oxygen carrier with either steam or CO₂. The third reactor, the combustor, combusts the partially oxidized

-7-

oxygen carrier in the oxidizer and the remaining portion of the reduced oxygen carrier from the reducer using air.

The feed for the oxidizer is the exhaust from the fuel cell anode side and the product of the oxidizer is directly used as the feed for the fuel cell anode. The oxidizer
5 enriches the fuel content in the working fluid (CO/H₂/CO₂/H₂O) stream. In preferred embodiments, the gaseous stream of the fuel cell anode side and the oxidizer forms a closed loop in which the addition and purging of the gaseous stream is minimal. To maintain the pressure of the working fluid, repressurization of the fluid is performed within the main loop or a split loop. In certain embodiments, a high temperature sorbent
10 bed such as that using calcium oxide based sorbent is integrated into the loop to prevent the accumulation of pollutants such as H₂S. In other cases, sulfur treatment is carried out only on the bleed stream, the main working fluid stream is not treated.

The oxygen carrier comprises a plurality of ceramic composite particles having at least one metal oxide disposed on a support. Ceramic composite particles are described
15 in Thomas, US Patent No. 7,767,191; Fan, PCT Application No. WO 2007082089; and Fan, PCT Application No. WO 2010037011.

Referring back to the reduction reaction in the first reactor of Figure 3, i.e. the reducer, the reducer utilizes various carbonaceous fuels such as syngas, methane and light hydrocarbons, coal, tars, oil shales, oil sands, tar sand, biomass, wax and coke to
20 reduce the iron oxide containing ceramic composite to produce a mixture of reduced metal and/or metal oxide. The possible reduction reactions include:

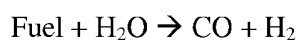
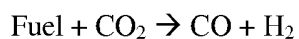

-8-

Specifically, metallic iron (Fe) is formed in the reducer. Simultaneously, an exhaust stream that contains at least 60% CO₂ (dry basis) is produced from the reducer. In preferred schemes, the CO₂ concentration exceeds 95% and is directly sequestrable.

The preferred designs for the reducer include a moving bed reactor with one or
5 more stages, a multistage fluidized bed reactor, a step reactor, a rotatory kiln or any
suitable reactors or vessels known to one of ordinary skill in the art that provide a
countercurrent gas-solid contacting pattern. The counter-current flow pattern between
solid and gas is adopted to enhance the gas and solid conversion. The counter-current
10 flow pattern minimizes the back-mixing of both solid and gas. Moreover, it maintains the
solid outlet of the reactor at a more reductive environment while the gas outlet of the
reactor is maintained at a more oxidative environment. As a result, the gas and solid
conversions are both enhanced.

Referring back to the oxidation reaction in the second reactor in Figure 3, i.e. the
oxidizer, the oxidizer converts the iron containing oxygen carrier particles from the
15 reducer to a higher oxidation state using the exhaust gas stream of the fuel cell anode,
which is rich in CO₂ and/or steam. The presence of unconverted fuel in this stream will
not participate in the reaction. The possible reactions include:

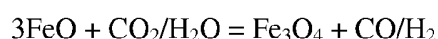
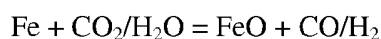

20 In certain embodiments, only a portion of the reduced oxygen carrier from the
reducer is introduced to the oxidizer with the rest bypassing the oxidizer and is directly
sent to the combustor. By doing this, more heat is generated from the redox block to
compensate for the reaction heat required in the reducer. Alternatively, a sub-
stoichiometric amount of fuel cell anode exhaust gas is sent to the oxidizer so that more
25 heat is produced in the combustor that follows.

Although unconverted fuel may be present in the fuel cell anode exhaust stream,
the fuel content in this gas stream is significantly enriched resulting from the reaction
between iron/iron oxide and H₂O/CO₂.

-9-

The preferred designs of the oxidizer also include a moving bed reactor and other reactor designs that provide a countercurrent gas-solid contacting pattern. A countercurrent flow pattern is preferred so that a high steam to hydrogen and CO₂ to CO conversion are achieved.

- 5 Referring back to the oxidation reaction in the third reactor in Figure 3, i.e. the combustor, oxygen containing gas such as air and/or partially converted air from the fuel cell cathode side is used to, at least partially, oxidize the iron in oxygen carrier generated from the oxidizer to Fe₂O₃. The reactions in the combustor include:

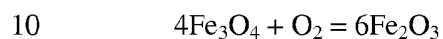
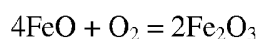

- The preferred reactor designs for the combustor include a fast fluidized bed reactor, an entrained bed reactor, a transport bed reactor, or a mechanical conveying system. The functions of the combustor include: oxidation of the oxygen carrier to a higher oxidation state; and re-circulation of the oxygen carrier to the inlet of the reducer
15 for another redox cycle.

- Figure 4 illustrates a schematic flow diagram of one embodiment of the reforming/water splitting block that converts gaseous fuel. In this embodiment, a gasification system is used to convert solid fuel such as coal, biomass, pet coke, and wax into a gaseous fuel. Sulfur in the gaseous fuel is removed using a high temperature
20 sorbent such as those containing calcium oxide, zinc oxide etc. The required sulfur level in the gaseous fuel is < 500 ppm. In preferred schemes, the sulfur level in the gaseous fuel is reduced to < 20 ppm.

- The fuel gas is then introduced to the reducer in Figure 4 as the fuel for the redox cycles. Alternative to the gaseous fuel from the gasifier, fuels from the reformer or
25 pyrolyzer can also be used in the redox system. Gaseous fuels such as methane and light hydrocarbon can also be directly introduced to the redox system as the fuel.

One difference between the process and system described in Fan, PCT Application No. WO 2010037011 and embodiments of the present invention is that the

-10-

gaseous feed for the second reactor, the oxidizer, contains fuel gas such as H₂ and CO in addition to H₂O and CO₂. In certain embodiments, the oxygen containing gas for the combustor comprises at least a portion of the exhaust gas from the cathode.

The combustor is highly exothermic. The heat generated in the combustor can be used to compensate for the heat required in the reducer. This heat can also be used to preheat the feed streams and to generate power for parasitic energy consumptions. The high pressure gaseous stream discharged from the system can be used to drive expanders for gas compression.

Table 1 illustrates the mass flow of the major streams in one embodiment of the process. Table 2 illustrates the energy balance of one embodiment of the system. In this case, methane is used as the fuel. H₂O/H₂ is used as the working fluid. The fuel cell block, which utilizes an SOFC system, converts the fuel (H₂) rich gas stream into 70% steam balanced with H₂. The HHV efficiency of the process, defined as the energy in the electricity product divided by the higher heating value of the methane feed, is greater than 60%. In this case, substantially all of the CO₂ produced is compressed to 1.52 x 10⁷ Pa (2200 psi) and is ready for sequestration.

Table 1. Mass Balance of the Integrated Reforming – Fuel Cell for Power Generation using Methane as the Fuel

Methane (feed, kmol/s)	CO ₂ from Reducer (kmol/s)*	H ₂ rich stream from oxidizer (kmol/s) ⁺	H ₂ O rich stream from fuel cell anode (kmol/s)
1.12	1.12	6.99	6.99

* the CO₂ stream contains less than 0.5% impurities such as unconverted fuel

⁺ exhaust from the oxidizer contains 70% H₂ and 30% steam

Table 2. Energy Balance of the Integrated Reforming – Fuel Cell for Power Generation using Methane as the Fuel

Methane (MW _{th})	Parasitic Power (MWe)	Power Production (MWe)	Net Power (MWe)
1000	80	700	620

In the case where coal and a coal gasifier are used, the process efficiency varies between 38 and 60% (HHV, with CO₂ capture) depending on the type of coal and coal gasifier. When biomass is gasified and used for the redox system, the efficiency is 1 –
5 10% less than its coal counterpart. Because all of the CO₂ in the biomass is captured, the net CO₂ emission from the system is negative from the life cycle analysis standpoint.

Referring to the embodiment illustrated in Figure 5, solid fuel such as coal, biomass, wax, heavy residue, pet coke, and tar sands are directly converted in the redox system without the need for a gasifier/pyrolyzer/reformer. This embodiment depicts a
10 direct coal redox system integrated with solid oxide fuel cell (SOFC) as exemplified herein.

Due to the high operating temperatures in a SOFC system, between about 800° C to 1000° C, a significant amount of heat is released and needs to be recovered to enhance the process efficiency. Current process designs usually combine SOFC and a gas turbine
15 – steam turbine system for full conversion of fuel to electricity. About 60%~90% of the fuel is converted in the SOFC first, and the remainder will be fully converted in a gas turbine system together with a bottoming Rankine cycle. However, the system is costly because all three components, i.e., the hydrogen production system, fuel cell, and turbine system, are capital intensive. Conventional IGCC-SOFC routes for electricity generation
20 can reach an efficiency of at most 55%.

The direct chemical looping (DCL) process, described in Fan, PCT Application No. WO 2010037011, converts solid fuels into hydrogen. Within the DCL system, an iron oxide based oxygen carrier circulates among three reactors which are the reducer, the oxidizer and the combustor. In the reducer, coal and/or biomass is gasified to CO₂
25 and H₂O by Fe₂O₃ containing particles which are reduced to Fe and FeO. A portion of the reduced particles react with steam in the oxidizer to produce hydrogen, while the remaining reduced particles together with the partially oxidized particles from the oxidizer, are fed to the combustor. Finally, Fe₂O₃ containing particles are regenerated and recycled back by combusting with oxygen containing gases such as pressurized air.
30 The heat, released in the combustor and carried over to the reducer by the iron oxides,

-12-

can fully compensate for any heat deficit in the system. By the DCL system, hydrogen and carbon dioxide are generated in different reactors, which saves a considerable amount of energy by eliminating the need for product separation. Also, it saves equipment investment costs on CO₂ removal and air separation units. The DCL system
5 can produce hydrogen at an efficiency of 70 - 85% from coal and 60 - 75% from biomass.

In this embodiment, we integrate the DCL system and SOFC system for high efficiency electricity generation from coal. The DCL-SOFC process and system have a number of configurations, either at high pressure or low pressure. Specifically, we describe the embodiment where the oxidizer and anode are integrated within a closed
10 loop of hydrogen and steam as shown in Figures 5 and 9.

1000MW thermal input is considered, and accordingly 131.8 tonne/hr of bituminous coal is processed in the DCL-SOFC system. Coal is first pulverized into proper size particles and then dried to 5% moisture from 7.23% by the flue gas. In the DCL system, a moving bed design is adopted for both the reducer and the oxidizer.
15 About 3549.5 tonne/hr oxygen carrier, containing 45.6% Fe₂O₃ and 54.4% Al₂O₃ (as inert) by weight, is fed into the top of the reducer, and the coal is injected from the middle part of the reducer. In the moving bed reducer, solid flows downward while gas ascends upward. The countercurrent design can fully convert coal into CO₂ and H₂O at 900 °C, 1.01 x 10⁵ Pa (1 atm). Iron oxide is reduced to the form of Fe, FeO and a trace of
20 FeS. 71.5% of the reduced iron particles are used for hydrogen generation in the oxidizer, and the other 28.5% are combusted in the combustor. The oxidizer operates at 850 °C, converting a gaseous mixture of 90.4% H₂O and 9.6% H₂ by mole into a mixture of 35.9% H₂O and 64.1% H₂ and ppm level of H₂S. The gaseous mixture is then fed to the anode of a sulfur tolerant SOFC for electricity generation. At the same time, Fe and FeO
25 will be oxidized to Fe₃O₄, which flows to the combustor for Fe₂O₃ regeneration.

An air blower drives 1992 tonne/hr of air to feed the DCL-SOFC system. The air is preheated up to 900 °C in the HRSG section, and then goes to the cathode of the SOFC device. 30% of the oxygen and 85% of the hydrogen are consumed in SOFC operating at 900 °C. The spent air is used in the combustor to regenerate Fe₂O₃ at 1280 °C.
30 The spent hydrogen/steam mixture will then be cooled to about 240 °C for subsequent

-13-

sulfur removal unit. Only a small amount of steam will be made up to the hydrogen/steam mixture before it recycles back to the oxidizer.

During the DCL-SOFC process, > 99% pure CO₂ is obtained by simple condensation followed by compression to 1.37×10^7 Pa (> 135 atm) for greenhouse gas control. The compression step consumes about 35.8 MW of work. The other pollutants such as Cl, S, and Hg can either be co-sequestered with CO₂ or removed by conventional techniques. Ash can be removed from the oxygen carrier by a cyclone positioned before the reducer.

Table 3 summarizes the flow of the main process streams. As a result of the integration of the DCL and SOFC, 535 MW of electricity can be produced by the DCL-SOFC system, and 96 MW of electricity can be generated from the steam turbine system by recovering low grade heat. The overall process can produce electricity of 640 MW with CO₂ compression, this is equal to a coal to power efficiency of 64% (HHV). The illustrated example can be further optimized to achieve greater than 70% efficiency.

The DCL-SOFC system can convert a wide range of combinations of coal and biomass to electricity with high efficiency. Possible designs also includes low pressure and temperature operation for the working fluid (the mixture of hydrogen and steam). H₂S in the hydrogen/steam mixture can be also removed before the SOFC with hot gas clean up unit. It is noted that when feeding the system with low sulfur fuel (approximately less than 0.2% by weight) such as biomass, no sulfur removal unit is needed.

Table 3 Process Flowsheet for the DCL-SOFC Process

Stream	0	1	2	3	4	5	6	7	8	9
Temperature °C	30	1280	901	901	850	1279.6	901	30	159.9	1279.6
Pressure atm	30	30	1	1	30	16	1	1	135	16
Mass Flow tonne/hr	131.878	3549.459	2336.231	931.225	2475.293	3549.459	402.831	348.195	348.195	1709.881
Volume Flow cum/hr	92.642	871.979	855.716	341.089	667.534	871.979	1.05E+06	195768.7	1754.619	481020.7

-14-

Density lb/cuft	88.868	254.118	170.438	170.438	231.49	254.118	0.024	0.111	12.388	0.222
Mass Flow tonne/hr										
H2O	0	0	0	0	0	0	53.058	0	0	0
CO2	0	0	0	0	0	0	348.195	348.195	348.195	0
O2	0	0	0	0	0	0	0	0	0	180.486
N2	0	0	0	0	0	0	1.19	0	0	1526.995
H2S	0	0	0	0	0	0	0	0	0	0
H2	0	0	0	0	0	0	0	0	0	0
O2S	0	0	0	0	0	0	0.388	0	0	0.141
O3S	0	0	0	0	0	0	0	0	0	0.006
NO	0	0	0	0	0	0	0	0	0	2.212
NO2	0	0	0	0	0	0	0	0	0	0.039
FE	0	0	326.047	129.963	0	0	0	0	0	0
FE0.947O	0	0	630.558	251.341	391.333	0	0	0	0	0
FE3O4	0	0	0	0	704.799	0	0	0	0	0
FE2O3	0	1620.562	0	0	0	1620.562	0	0	0	0
FE0.877S	0	0	0.464	0.185	0	0	0	0	0	0
AL2O3	0	1928.897	1379.162	549.736	1379.162	1928.897	0	0	0	0
COAL	131.878	0	0	0	0	0	0	0	0	0
Stream	10	11	12	13	14	15	16	17	18	19
Temperature °C	120	25	59.1	900	900	850	900	240	30	600
Pressure atm	16	1	2	2	2	30	30	30	124	124
Mass Flow tonne/hr	1709.881	1992.014	1992.014	1992.014	1852.821	123.993	263.185	263.185	360.398	360.398
Volume Flow cum/hr	121911.2	1.69E+06	940966.6	3.32E+06	3.12E+06	49218.57	51174.16	20307.05	425.414	10786.28
Density lb/cuft	0.876	0.074	0.132	0.037	0.037	0.157	0.321	0.809	52.887	2.086

-15-

Mass Flow tonne/hr										
H2O	0	0	0	0	0	103.165	259.895	259.895	360.398	360.398
CO2	0	0	0	0	0	0	0	0	0	0
O2	180.486	463.974	463.974	463.974	324.782	0	0	0	0	0
N2	1526.995	1528.04	1528.04	1528.04	1528.04	0	0	0	0	0
H2S	0	0	0	0	0	0.195	0.195	0.195	0	0
H2	0	0	0	0	0	20.633	3.095	3.095	0	0
O2S	0.141	0	0	0	0	0	0	0	0	0
O3S	0.006	0	0	0	0	0	0	0	0	0
NO	2.212	0	0	0	0	0	0	0	0	0
NO2	0.039	0	0	0	0	0	0	0	0	0

Table 4. Coal to Electricity Process Configurations and Process Efficiencies

Process Configuration	Conventional Gasification – WGS -SOFC	DCL-SOFC without integration	DCL-SOFC with combustor-cathode integration	DCL-SOFC with closed oxidizer-anode loop and combustor integration	DCL-SOFC with further heat integration of reducer
Efficiency (%HHV with CO ₂ capture)	38 – 48%	50 – 55%	51 – 57%	58 – 64%	66 – 71%

Although the DCL-SOFC system and process exemplified in this embodiment is
5 specific to working fluid compositions, type of reforming/water splitting block, and fuel
cell block, the choices of aforementioned parameters have a large degree of freedom. For
instance, CO and CO₂ can be used instead of H₂/H₂O as the working fluid. The various
configurations described in Fan, PCT Application No. WO 2010037011 can be used in
the reforming/water splitting block. Other fuel cells such as molten carbonate fuel cell
10 (MCFC) can also be integrated with the DCL system. In this case, a portion of the CO₂
generated from the DCL reducer is injected to the cathode side of the MCFC to facilitate

-16-

the conversion. In addition, the DCL system can be configured so that the gaseous exhaust from the reducer is not fully converted. In this case, the unconverted fuel is sent to another fuel cell and/or oxygen polishing step prior to obtaining a concentrated CO₂ stream (see Figure 10). When all the reduced oxygen carrier particles are used for hydrogen production, i.e. the split ratio for direct combustion is 0, and assuming high grade heat in the fluegas from the combustor can be used to heat up the reducer, the electricity generation efficiency can reach 70% with CO₂ compression. Table 4 shows the several configurations and corresponding power generation efficiencies.

Figure 6 illustrates an embodiment in which a calcium sorbent enhances the reforming process and is used as the reforming/water splitting block. In this case, the fuel is reformed/shifted to H₂ with the presence of CaO/Ca(OH)₂ sorbent and steam/steam rich exhaust gas from the fuel cell anode:

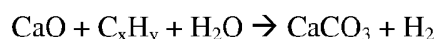

The spent sorbent is then regenerated at high temperatures using the waste heat from the system in the calciner:

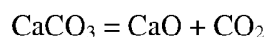

A hydration step is optionally added to reactivate the sorbent. The concentrated CO₂ from the calciner is then compressed and sequestered. In this case, a portion of the working fluid can be split to avoid accumulation of the working fluid.

Figure 7 illustrates the option of using a membrane enhanced reformer/water gas shift reactor as the reforming/water splitting block. In this embodiment, the fuel is reformed/shifted in the reformer, and CO₂ is simultaneously removed from the membrane. The retentate side of reformer enriches the working fluid with reformed fuel, while the permeate side produces concentrated CO₂.

Figure 8 illustrates an embodiment showing the integration of a zinc oxide water splitting cycle and the fuel cell. In this embodiment, thermal energy from a solar or nuclear source is used to facilitate the zinc oxide based water splitting cycle. The

-17-

hydrogen obtained from the splitting of water is used to enrich the working fluid comprising H₂O and H₂.

5 It will be apparent to those skilled in the art that various changes may be made without departing from the scope of the invention which is not considered limited to the specific embodiments described in the specification and drawings, but is only limited by the scope of the appended claims.

-18-

CLAIMS

1. A system for converting carbonaceous fuel or thermal energy into electricity comprising:
 - 5 a reforming/water splitting block for converting a steam and/or CO₂ rich gas stream and carbonaceous fuel and/or thermal energy into a fuel (H₂ and/or CO) rich gas stream and an exhaust gas stream;
 - a fuel cell block for converting the fuel rich gas stream and an oxygen containing gas stream into a lean fuel gas stream and a spent oxygen containing gas stream from anode and cathode, respectively; and
 - 10 a closed loop between the reforming/water splitting block and fuel cell block.
3. A system as claimed in claim 1 in which the fuel cell block comprises a solid oxide fuel cell or a molten carbonate fuel cell.
4. A system as claimed in claim 1 in which the carbonaceous fuel comprises syngas, carbon monoxide, methane rich gas, light hydrocarbons, liquid carbonaceous fuels, coal,
15 biomass, tar sand, oil shale, petroleum coke, heavy liquid hydrocarbons, wax, and mixtures thereof.
5. A system as claimed in claim 1 in which less than 10% of the fuel rich or steam/CO₂ rich gas stream is purged.
6. A system as claimed in claim 1 in which the thermal energy comprises either
20 solar or nuclear energy.
7. A system as claimed in claim 1 in which the fuel rich stream is produced through water splitting, electrolysis, sorbent or membrane enhanced reforming and/or water gas shift reaction, or steam-iron reaction.
8. A system as claimed in claim 1 in which the redox property of a metal oxide
25 particle is used to assist in the carbonaceous fuel conversion.

-19-

9. A system as claimed in claim 1 in which a calcium oxide sorbent is used to enhance the carbonaceous fuel conversion.
10. A method for producing electricity and a separate CO₂ rich stream from a carbonaceous fuel and steam comprising:
- 5 reducing a Fe₂O₃ containing particle to a lower oxidation state including metallic iron by reacting the particle with a carbonaceous fuel in a first reaction zone;
- oxidizing at least a portion of the metallic iron containing particle with a steam or CO₂ rich gas from a fuel cell anode in a second reaction zone while generating a fuel (H₂ and/or CO) rich gas stream;
- 10 returning the fuel rich gas stream from the second reaction zone to the anode of the fuel cell;
- oxidizing the remaining metallic iron containing particle from the first reaction zone and the iron oxide containing particle obtained from the oxidation reaction in the second reaction zone with an oxygen containing gas to produce a Fe₂O₃ containing
- 15 particle in a third reaction zone; and
- returning the Fe₂O₃ containing particle to the first reaction zone.
11. A method as claimed in claim 10 in which the fuel cell comprises a stack of solid oxide fuel cells.
12. A method as claimed in claim 10 in which the carbonaceous fuel comprises
- 20 syngas, carbon monoxide, methane rich gas, light hydrocarbons, liquid carbonaceous fuels, coal, biomass, tar sand, oil shale, petroleum coke, heavy liquid hydrocarbons, wax, and mixtures thereof.
13. A method as claimed in claim 10 in which the remaining CO₂ is sequestered after condensing out the moisture.

-20-

14. A method as claimed in claim 10 in which at least a portion of the oxygen containing gas used in the third reaction zone is the oxygen containing gas produced from the outlet of the fuel cell cathode.
15. A method as claimed in claim 10 in which at least a portion of the oxygen
5 containing gas exiting the third reaction zone is introduced to the inlet of the fuel cell cathode.
16. A method as claimed in claim 10 in which less than 10% of the fuel rich or steam/CO₂ rich gas stream is purged.
17. A method as claimed in claim 10 in which the metal oxide particle contains
10 supporting material comprising a ceramic material selected from at least one of the group consisting of oxides of Al, Ti, Zr, Y, Si, La, CR, Mg, Mn, Cu, Ca, carbides of Si and Ti, sepiolite, bentonite, and kaolin.
18. A method as claimed in claim 10 in which the steam of CO₂ rich gas or a portion
15 of the fuel rich stream are introduced to the bottom of the first reaction zone to enhance the conversions of both the iron oxide particles and the carbonaceous fuels.
19. A method as claimed in claim 10 in which the carbonaceous fuel is in the form of solid particles which are suspended by the gases in the first reaction zone until they are at least 50% converted before being elutriated towards the top of the first reaction zone.
20. A method as claimed in claim 10 in which the fuel rich or steam/CO₂ rich stream
20 purged from the closed loop is repressurized and introduced back to the closed loop.
21. A method as claimed in claim 10 in which heat released from the said third reaction zone is used to preheat the feed gas streams to the fuel cell cathode or the third reaction zone.
22. A method as claimed in claim 10 in which the fuel cell comprises a molten
25 carbonate fuel cell and at least a portion of the CO₂ required by the fuel cell cathode is provided by the CO₂ rich gas stream produced by the first reaction zone.

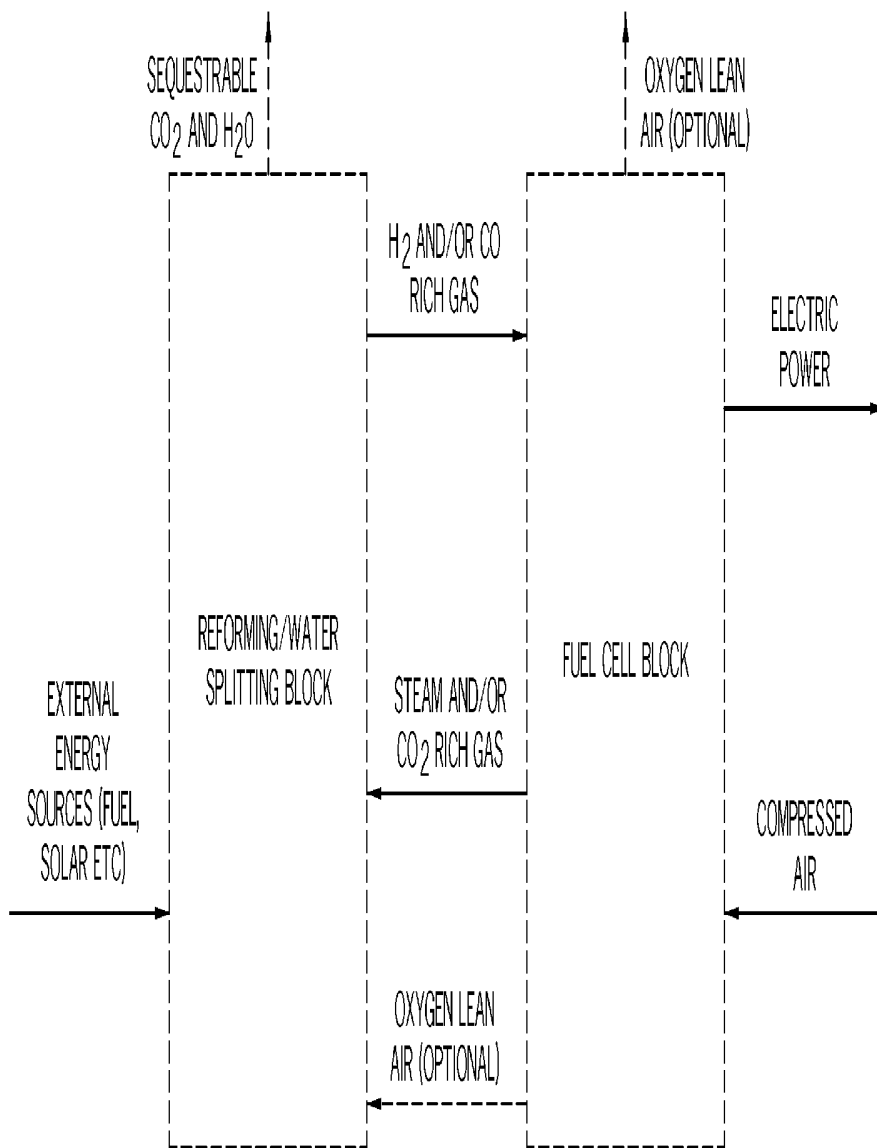

FIG. 1

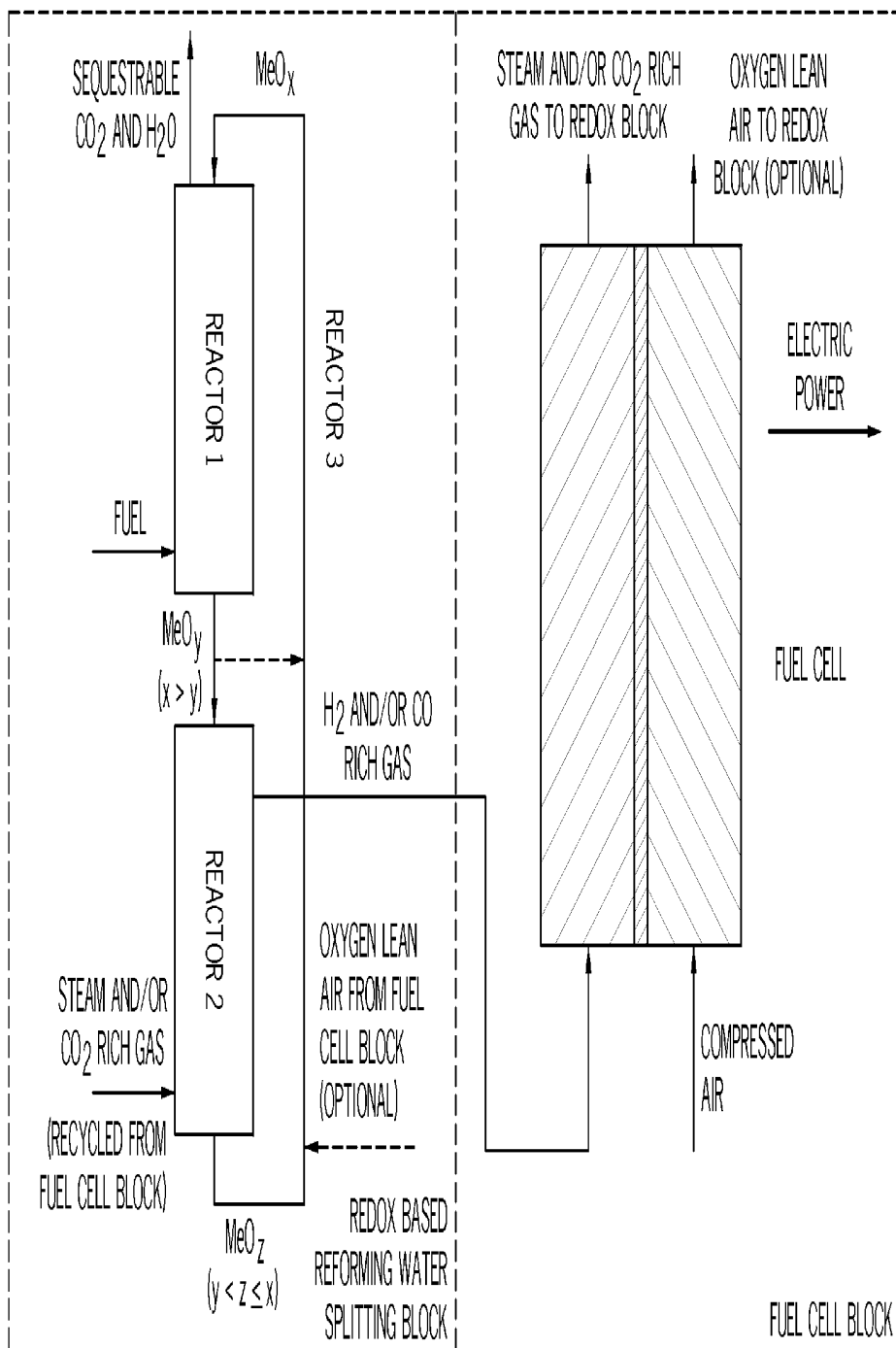

FIG. 2

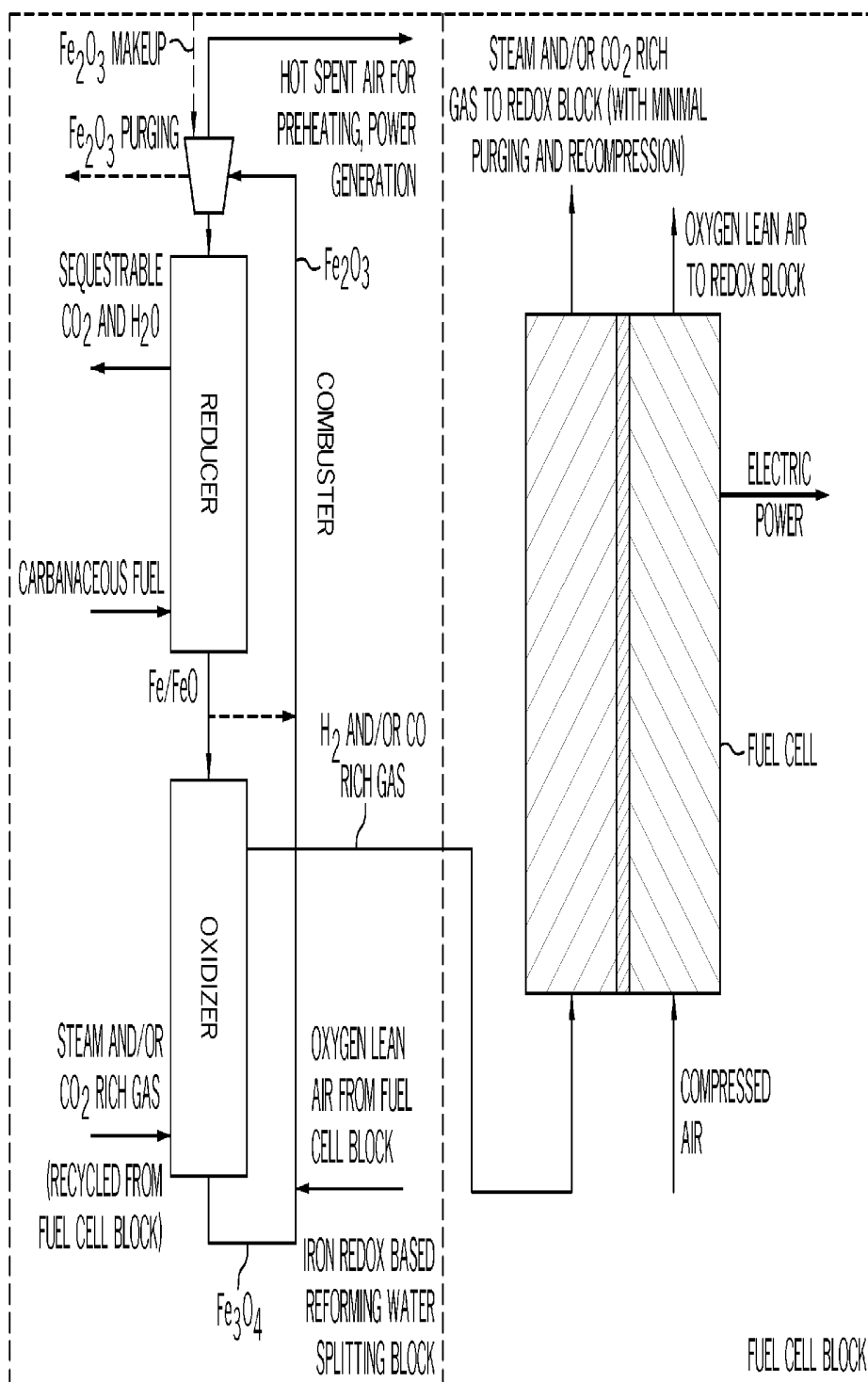

FIG. 3

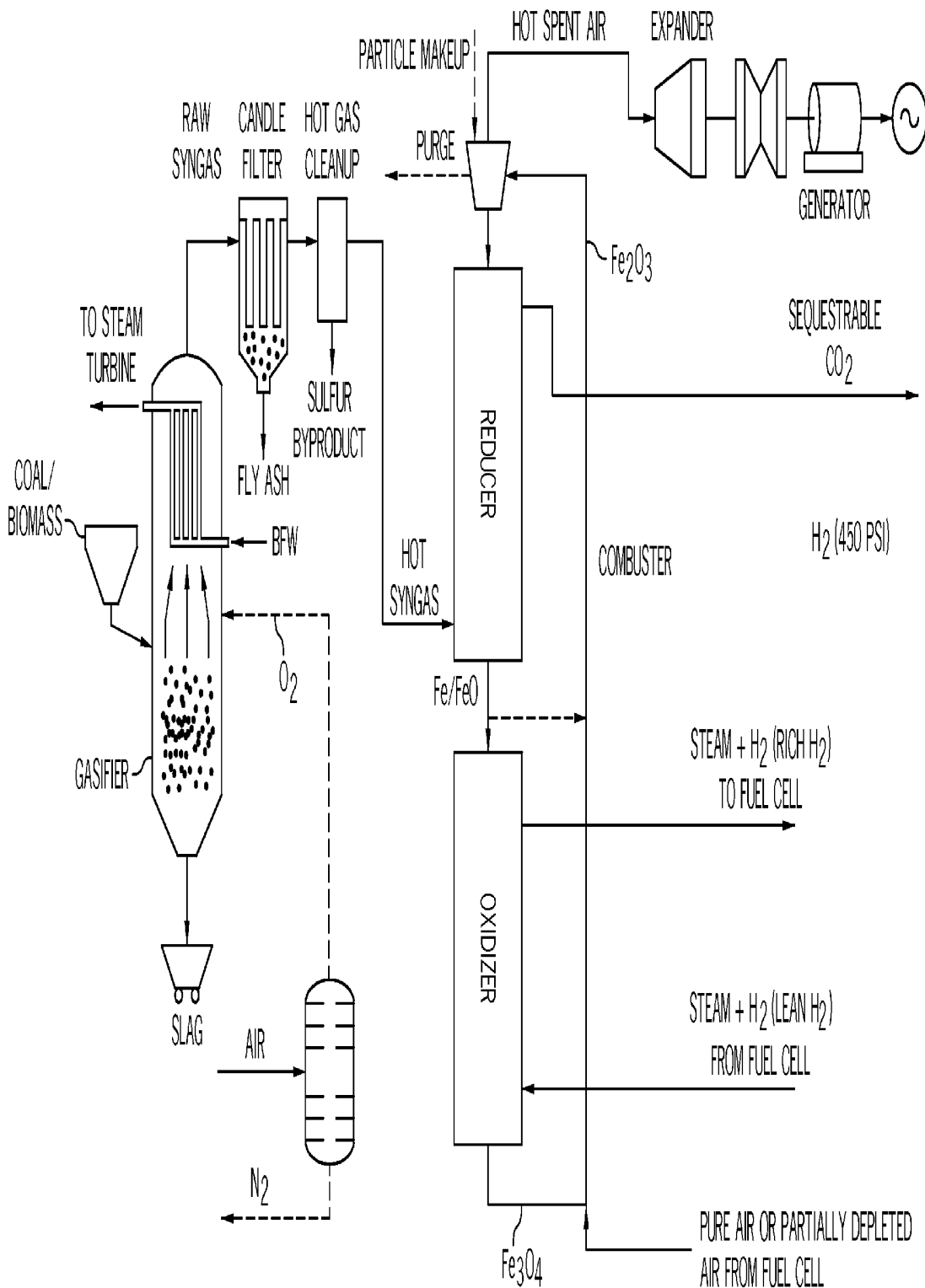

FIG. 4

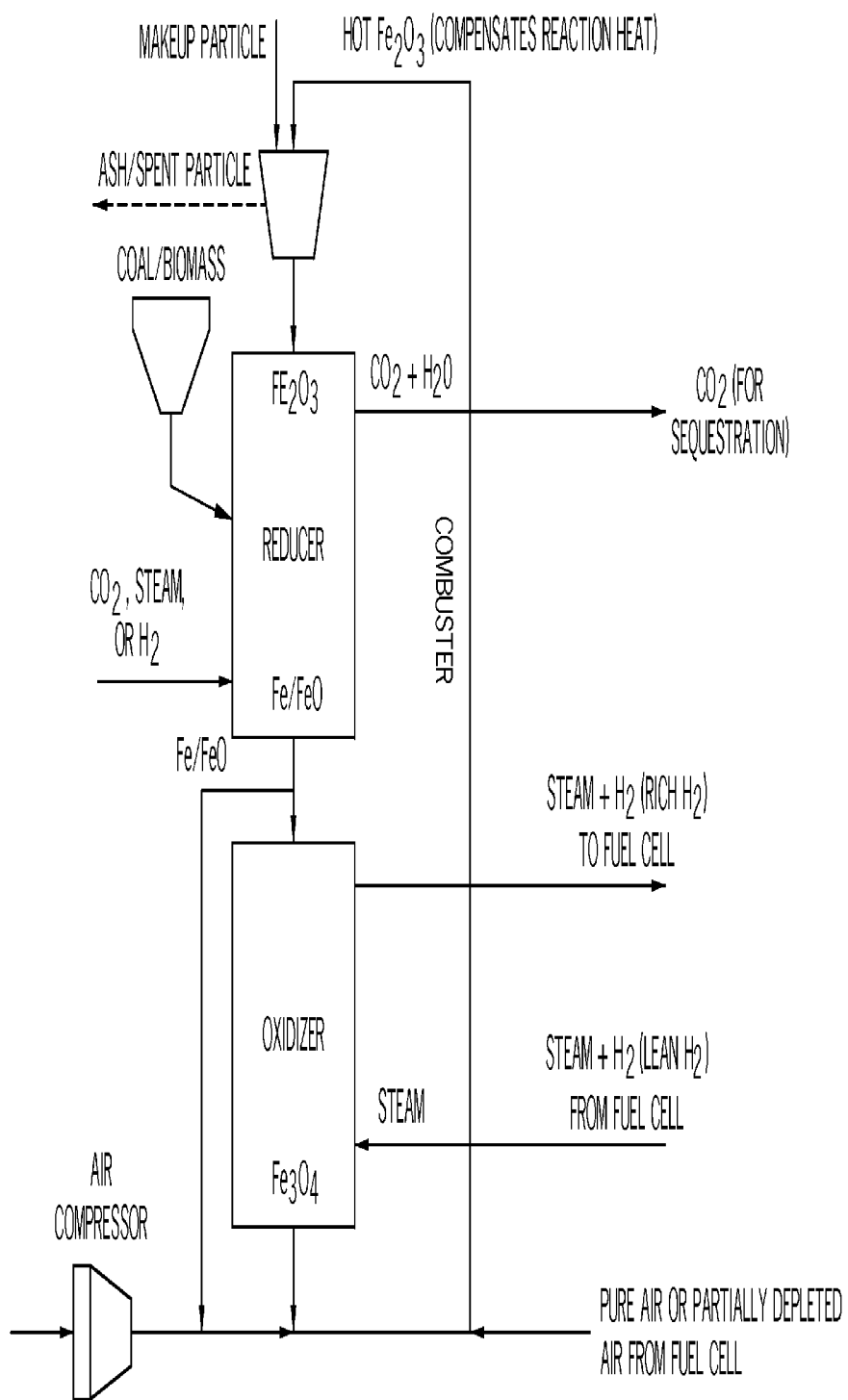

FIG. 5

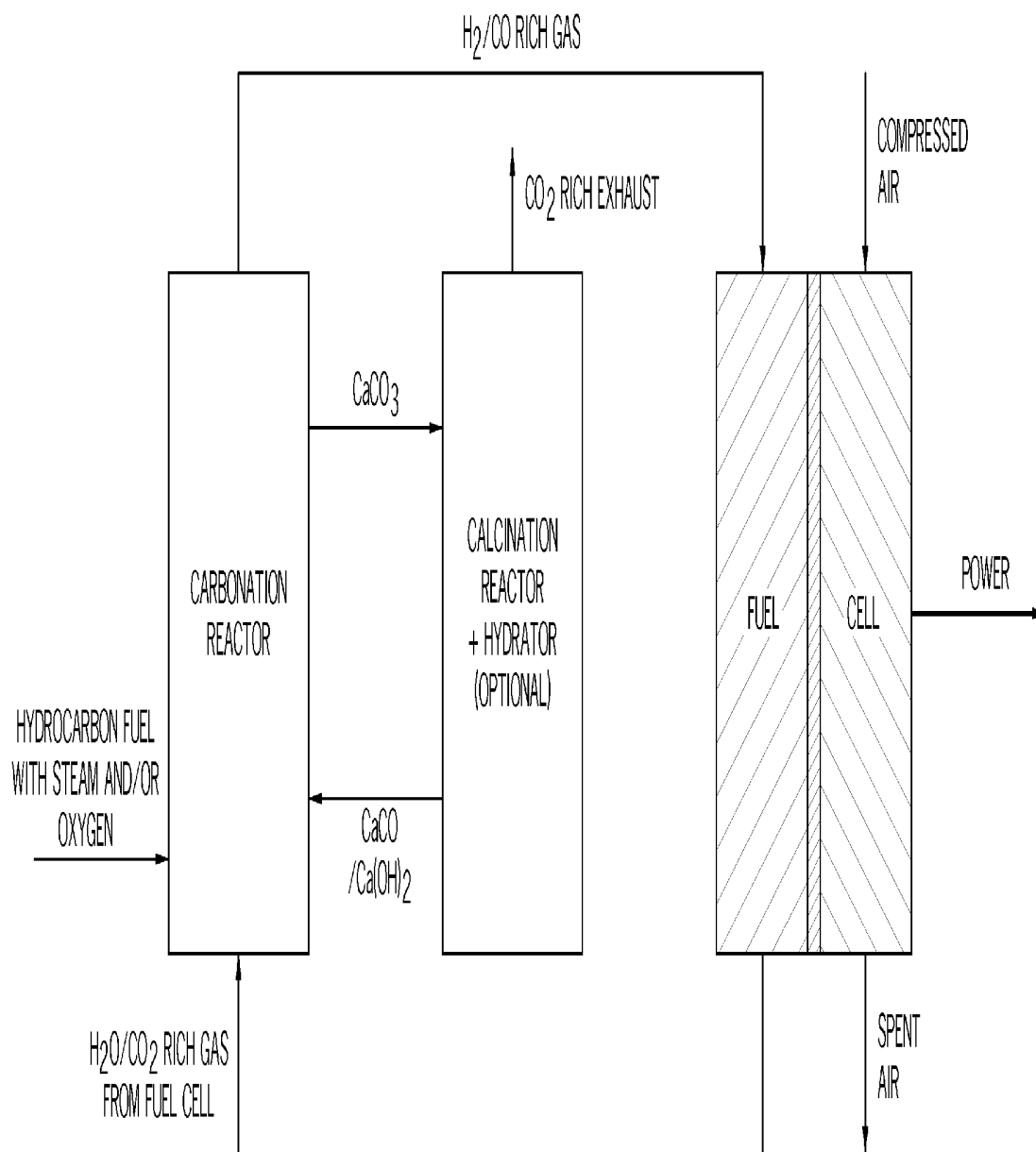

FIG. 6

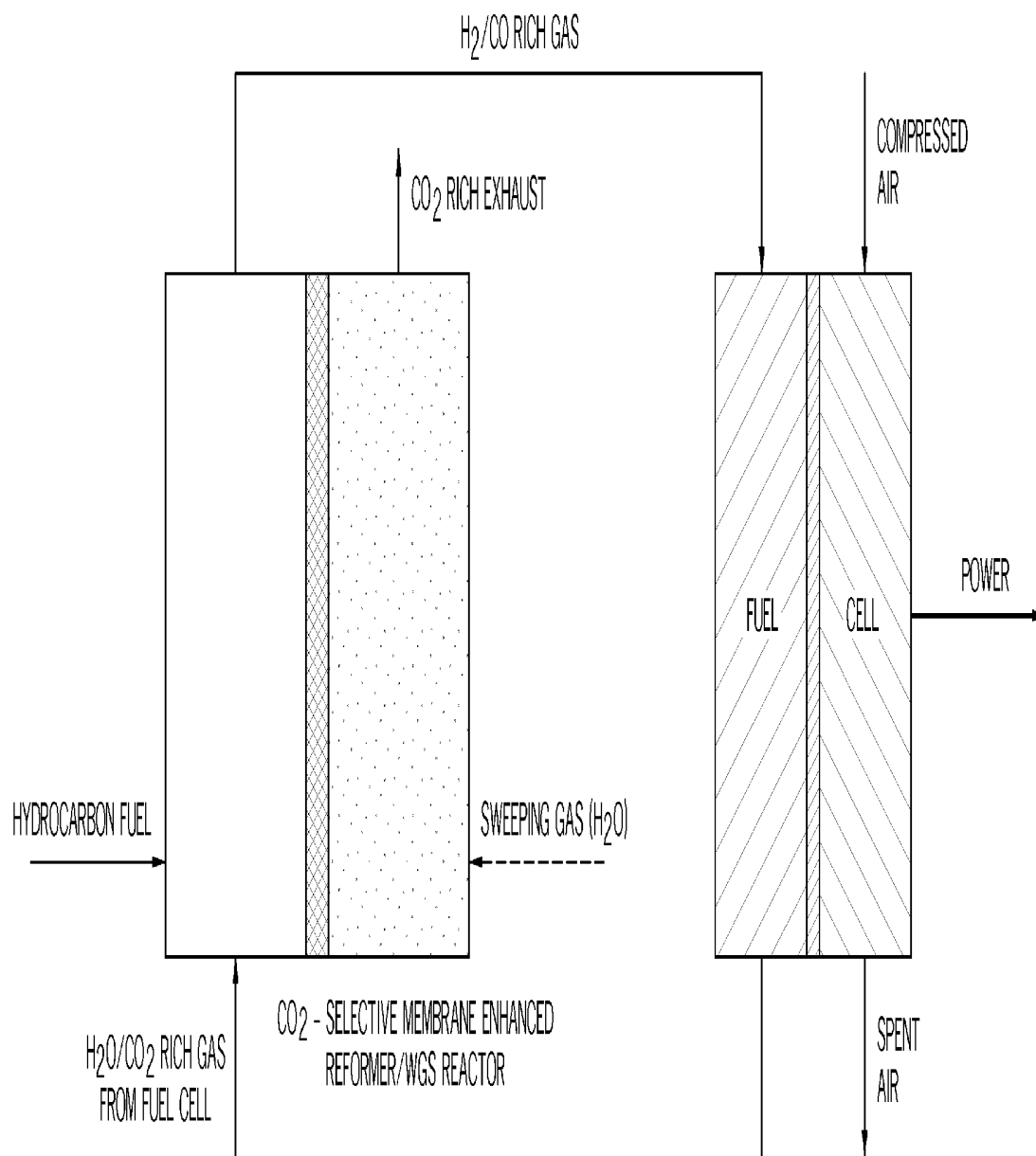

FIG. 7

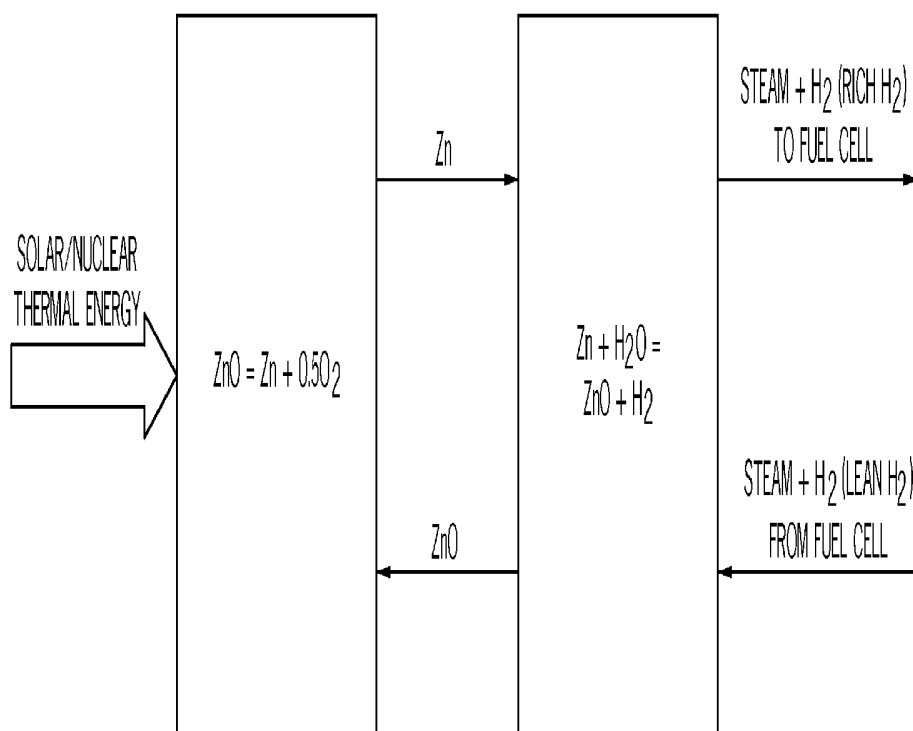

FIG. 8

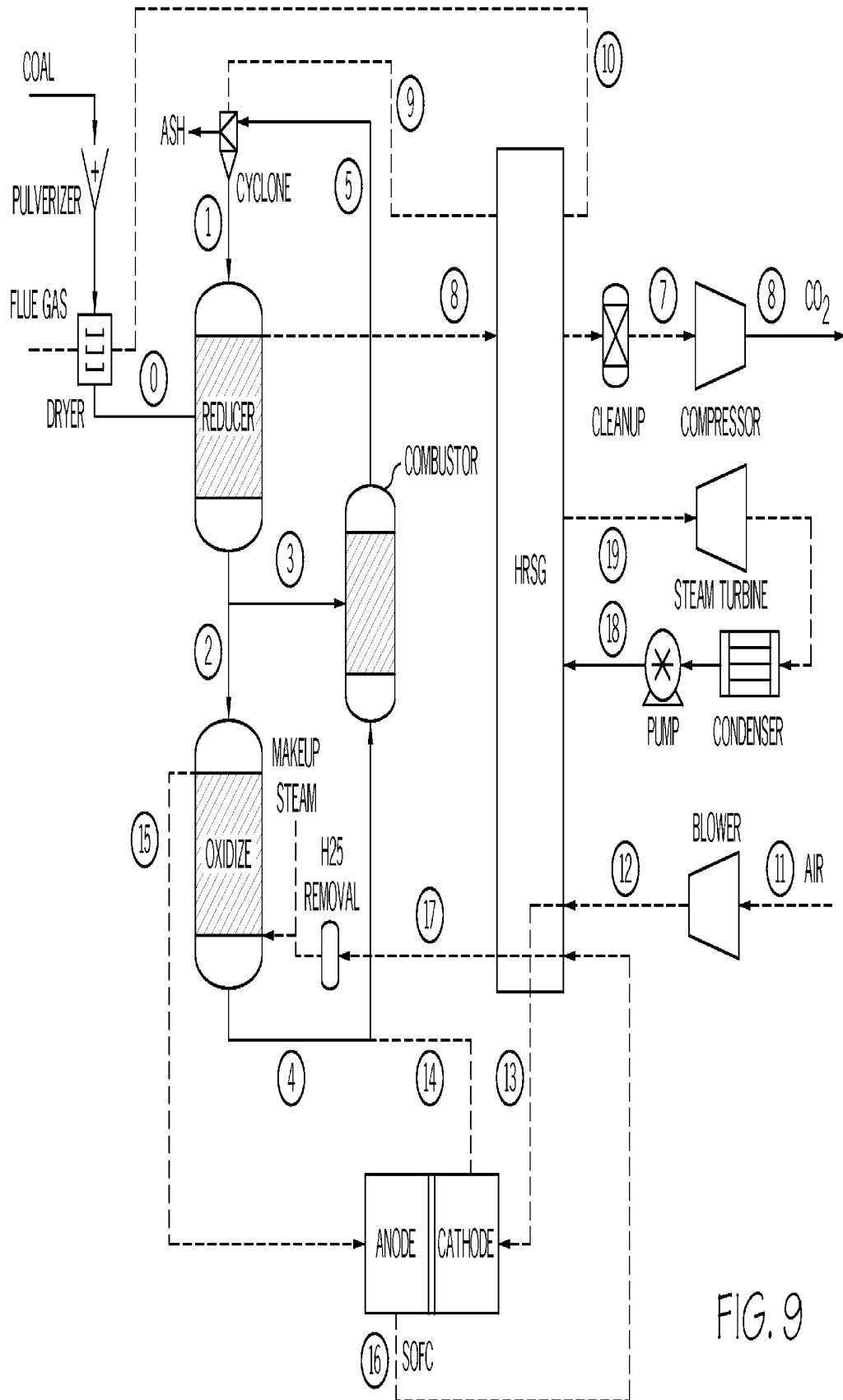

FIG. 9

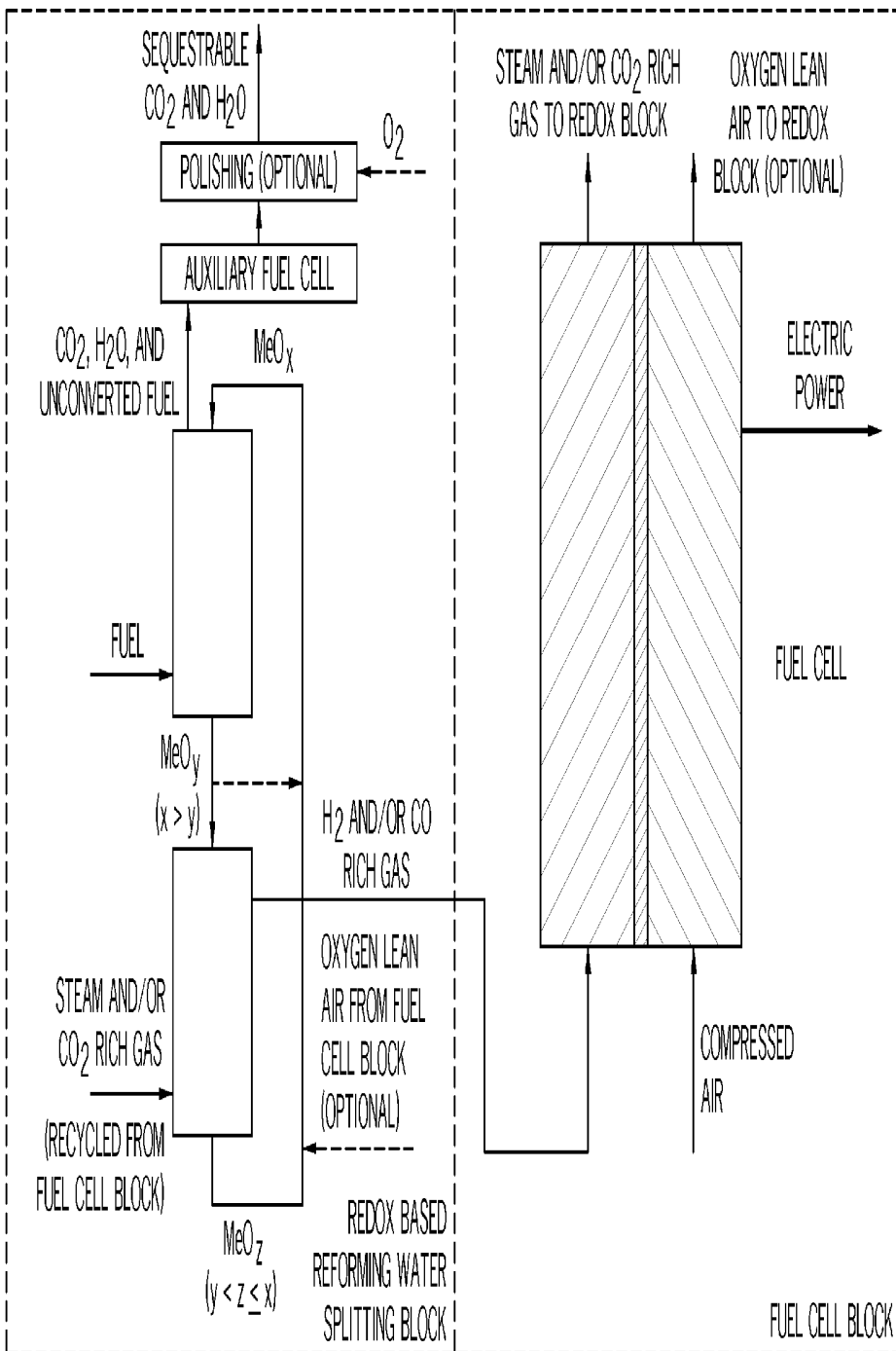

FIG. 10

INTERNATIONAL SEARCH REPORT

International application No
PCT/US2010/048125

A. CLASSIFICATION OF SUBJECT MATTER
INV. C01B3/34 C01B3/06
ADD. H01M8/06

According to International Patent Classification (IPC) or to both national classification and IPC

B. FIELDS SEARCHED

Minimum documentation searched (classification system followed by classification symbols)
C01B

Documentation searched other than minimum documentation to the extent that such documents are included in the fields searched

Electronic data base consulted during the international search (name of data base and, where practical, search terms used)

EP0-Internal

C. DOCUMENTS CONSIDERED TO BE RELEVANT

Category*	Citation of document, with indication, where appropriate, of the relevant passages	Relevant to claim No.
X	EP 1 845 579 A2 (EBERSPAECHER J GMBH & CO [DE]) 17 October 2007 (2007-10-17) paragraphs [0016], [0025]; figure 1	1-5
X	EP 1 138 096 A1 (NORTHWEST POWER SYS LLC [US] IDATECH LLC [US]) 4 October 2001 (2001-10-04) paragraph [0143] - paragraph [0156]; figure 27	1-5,7
X	WO 99/65097 A1 (MOBIL OIL CORP [US]) 16 December 1999 (1999-12-16) page 7, line 11 - page 23, line 25; figures 1-2	1-5,7
	----- -/--	

Further documents are listed in the continuation of Box C.

See patent family annex.

* Special categories of cited documents :

- "A" document defining the general state of the art which is not considered to be of particular relevance
- "E" earlier document but published on or after the international filing date
- "L" document which may throw doubts on priority claim(s) or which is cited to establish the publication date of another citation or other special reason (as specified)
- "O" document referring to an oral disclosure, use, exhibition or other means
- "P" document published prior to the international filing date but later than the priority date claimed

- "T" later document published after the international filing date or priority date and not in conflict with the application but cited to understand the principle or theory underlying the invention
- "X" document of particular relevance; the claimed invention cannot be considered novel or cannot be considered to involve an inventive step when the document is taken alone
- "Y" document of particular relevance; the claimed invention cannot be considered to involve an inventive step when the document is combined with one or more other such documents, such combination being obvious to a person skilled in the art.
- "&" document member of the same patent family

Date of the actual completion of the international search

9 December 2010

Date of mailing of the international search report

17/12/2010

Name and mailing address of the ISA/

European Patent Office, P.B. 5818 Patentlaan 2
NL - 2280 HV Rijswijk
Tel. (+31-70) 340-2040,
Fax: (+31-70) 340-3016

Authorized officer

Cristescu, Ioana

INTERNATIONAL SEARCH REPORT

International application No

PCT/US2010/048125

C(Continuation). DOCUMENTS CONSIDERED TO BE RELEVANT

Category*	Citation of document, with indication, where appropriate, of the relevant passages	Relevant to claim No.
X	STEINFELD A ET AL: "DESIGN ASPECTS OF SOLAR THERMOCHEMICAL ENGINEERING-A CASE STUDY: TWO-STEP WATER-SPLITTING CYCLE USING THE Fe ₃ O ₄ /FeO REDOX SYSTEM", SOLAR ENERGY, PERGAMON PRESS. OXFORD, GB, vol. 65, no. 1, 1 January 1999 (1999-01-01), pages 43-53, XP004362617, ISSN: 0038-092X, DOI: DOI:10.1016/S0038-092X(98)00092-9 paragraph [0004]; figure 2 -----	1-3,5-7
X	STEINFELD A: "Solar hydrogen production via a two-step water-splitting thermochemical cycle based on Zn/ZnO redox reactions", INTERNATIONAL JOURNAL OF HYDROGEN ENERGY, ELSEVIER SCIENCE PUBLISHERS B.V., BARKING, GB, vol. 27, no. 6, 1 June 2002 (2002-06-01), pages 611-619, XP004345166, ISSN: 0360-3199, DOI: DOI:10.1016/S0360-3199(01)00177-X paragraph [0002]; figure 1 -----	1-3,5-7
X	US 2005/175533 A1 (THOMAS THEODORE J [US] ET AL THOMAS THEODORE J [US] ET AL) 11 August 2005 (2005-08-11) cited in the application paragraphs [0042], [0056], [0063] - paragraph [0064]; claims 1-2; figures 4,5 -----	1-5,8, 10-13, 16-20
X	WO 01/42132 A1 (UNIV CALIFORNIA [US]) 14 June 2001 (2001-06-14) page 8, line 15 - page 25, line 17; figures 1,2 -----	1-4,8,9

INTERNATIONAL SEARCH REPORT

Information on patent family members

International application No

PCT/US2010/048125

Patent document cited in search report	Publication date	Patent family member(s)	Publication date	
EP 1845579	A2	17-10-2007	AT 484856 T DE 102006017614 A1	15-10-2010 18-10-2007
EP 1138096	A1	04-10-2001	AU 3560699 A BR 9914560 A CA 2345966 A1 JP 3898892 B2 JP 2003522087 T JP 3857119 B2 JP 2003277019 A JP 3556638 B2 JP 2003282119 A WO 0022690 A1	01-05-2000 26-06-2001 20-04-2000 28-03-2007 22-07-2003 13-12-2006 02-10-2003 18-08-2004 03-10-2003 20-04-2000
WO 9965097	A1	16-12-1999	AU 4424999 A CA 2334359 A1 EP 1101251 A1 JP 2002518792 T	30-12-1999 16-12-1999 23-05-2001 25-06-2002
US 2005175533	A1	11-08-2005	NONE	
WO 0142132	A1	14-06-2001	AU 772704 B2 AU 2079801 A CA 2394070 A1 CN 1407948 A EP 1240100 A1 JP 2003516294 T NO 20022734 A PL 355570 A1 US 6790430 B1	06-05-2004 18-06-2001 14-06-2001 02-04-2003 18-09-2002 13-05-2003 09-08-2002 04-05-2004 14-09-2004